

HANDBOOK 1

Timber Structures

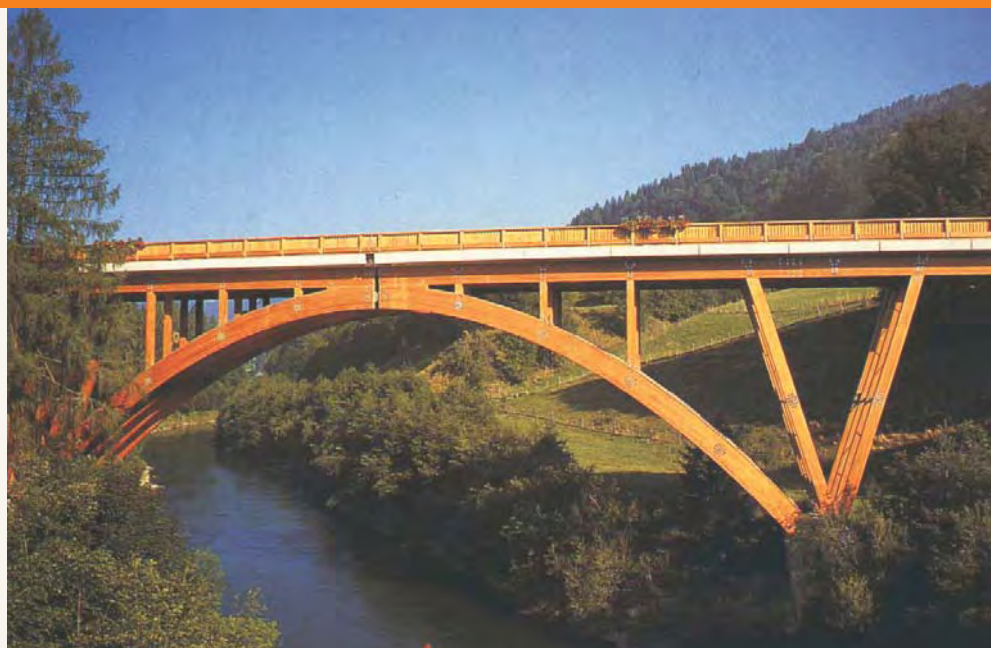

Leonardo da Vinci Pilot Project
CZ/06/B/F/PP/168007
Educational Materials for Designing
and Testing of Timber Structures





Leonardo da Vinci



Leonardo da Vinci Pilot Project
CZ/06/B/F/PP/168007

Educational Materials for Designing and
Testing of Timber Structures - TEMTIS

HANDBOOK 1 - TIMBER STRUCTURES

September 2008



Leonardo da Vinci

Handbook 1



Leonardo da Vinci Pilot Projects
“Educational Materials for Designing and Testing of Timber Structures – TEMTIS”
Handbook 1 – Timber Structures

This project has been funded with support from the European Commission. This publication reflects the views only of the author, and the Commission cannot be held responsible for any use which may be made of the information contained therein.

© 2008 by the authors of the papers

First Edition 2008

ISBN xxx-xxx xxxx



CONTENTS

Preface	VII
Chapter 1 Petr KUKLÍK, Czech Technical University in Prague / CZ History of Timber Structures	1
Chapter 2 Petr KUKLÍK, Czech Technical University in Prague / CZ Wood Properties	15
Chapter 3 Manfred AUGUSTIN, Graz University of Technology / AT Structural Timber	28
Chapter 4 Manfred AUGUSTIN, Graz University of Technology / AT Wood Adhesives	39
Chapter 5 Kjell Arne MALO, Vanessa ANGST, Norwegian University of Science and Technologie / NO Glued Laminated Timber	48
Chapter 6 Manfred AUGUSTIN, Graz University of Technology / AT Wood Based Panels	63
Chapter 7 Alois MATERNA, Antonín LOKAJ, Technical University of Ostrava / CZ Design of Timber Structures	100



Chapter 8	Miroslav PREMROV, University of Maribor / SI	
	Serviceability Limit States	110
Chapter 9	Alois MATERNA, Antonín LOKAJ, Technical University of Ostrava / CZ	
	Ultimate Limit States – Structural Members	119
Chapter 10	Manfred AUGUSTIN, Graz University of Technology / AT	
	Ultimate Limit States – Joints	136
Chapter 11	Miroslav PREMROV, Matjaz TAJNIK, University of Maribor / SI	
	Planar Timber Structures	158
Chapter 12	Alois MATERNA, Antonín LOKAJ, Technical University of Ostrava / CZ	
	Spatial Timber Structures	170
Chapter 13	Miroslav PREMROV, University of Maribor / SI	
	Timber Frame Houses	180
Chapter 14	Anders Søvsvø HANSEN, VIA University College / DK	
	Bracings of Timber Buildings	199
Chapter 15	Kolbein BELL, Norwegian University of Science and Technology / NO	
	Timber Bridges	209
Chapter 16	Andrzej MARYNOWICZ, University of Opole / PL	
	Durability of Timber Structures	227
Chapter 17	Petr KUKLÍK, Czech Technical University in Prague / CZ	
	Fire resistance of Timber Structures	233
Chapter 18	Andrzej MARYNOWICZ, University of Opole / PL	
	Timber Structures in Aggressive Environment	240



LIST OF CONTRIBUTORS

(in alphabetical order)

- | | |
|----------------------|---|
| Vanessa ANGST | Norwegian University of Science and Technology
Department of Structural Engineering
Rich. Birkelands vei 1a, N0-7491 Trondheim
vanessa.angst-nicollier@ntnu.no
http://www.ntnu.no |
| Manfred AUGUSTIN | Graz University of Technology
Institute of Timber Engineering and Wood Technology
Inffeldgasse 24, A-8010 Graz
manfred.augustin@lignum.tugraz.at
http://www.lignum.at |
| Kolbein BELL | Norwegian University of Science and Technology
Department of Structural Engineering
Rich. Birkelands vei 1a, N0-7491 Trondheim
kolbein.bell@ntnu.no
http://www.ntnu.no |
| Anders Søvsvø HANSEN | VIA University College
School of Technology and Business
Chr. M. Østergaards Vej 4, DK-8700 Horsens
ash@viauc.dk
http://www.viauc.dk |
| Petr KUKLÍK | Czech Technical University in Prague
Faculty of Civil Engineering
Department of Steel and Timber Structures
Thákurova 7, CZ-166 29 Prague 6
kuklik@fsv.cvut.cz
http://www.ocel-drevo.fsv.cvut.cz |



Leonardo da Vinci

Handbook 1



Antonín LOKAJ	VŠB – Technical University of Ostrava Faculty of Civil Engineering L. Podéště 1875, CZ-708 33 Ostrava antonin.lokaj@vsb.cz http://www.fast.vsb.cz
Kjell Arne MALO	Norwegian University of Science and Technology Department of Structural Engineering Rich. Birkelands vei 1a, NO-7491 Trondheim kjell.malo@ntnu.no http://www.ntnu.no
Andrzej MARYNOWICZ	Technical University of Opole Faculty of Civil Engineering Katowicka 48, PL- 45-061 Opole a.marynowicz@po.opole.pl http://mara.po.opole.pl/
Alois MATERNA	VŠB – Technical University of Ostrava Department of Civil Engineering L. Podéště 1875, CZ-708 33 Ostrava alouis.materna@vsb.cz http://www.fast.vsb.cz
Miroslav PREMROV	University of Maribor Faculty of Civil Engineering Smetanova ulica 17, SI-2000 Maribor miroslav.premrov@uni-mb.si http://www.fg.uni-mb.si/
Matjaz TAJNIK	University of Maribor Faculty of Civil Engineering Smetanova ulica 17, SI-2000 Maribor matjaz.tajnik@uni-mb.si http://www.fg.uni-mb.si/



PREFACE

As a building material, wood or perhaps more appropriate timber, has a number of excellent properties: high strength to weight ratio, it can be easily shaped and connected, it is one of the most sustainable resources available to man, it is environmentally friendly and it is an aesthetically pleasing material. However, timber also possesses properties that can cause problems or difficulties if not properly addressed: its mechanical properties exhibits large variability and is highly dependent on moisture content and load duration. Timber is a highly anisotropic material and its strength and stiffness properties perpendicular to grain are much lower than in the direction of the fibres, and perpendicular to grain timber also shrink and swell with varying moisture content which makes it susceptible to cracking. Finally, wood burns and it can be degraded by insects and fungi. The latter, which is vital for the durability of timber structures, is very dependent on the moisture content. All these potential problems of timber as a building material have made a significant number of engineers and to some extent also public opinion somewhat sceptical.

It is the purpose, not only of this handbook, but the entire project to overcome this scepticism, and to show that with the proper knowledge it is possible to build functional, economical and durable buildings of all types and sizes with timber, on its own or in combination with steel and/or reinforced concrete. Centuries of experience of the use of timber in buildings coupled with extensive research over the past few decades, has shown us the safe methods of construction, connection details and design limitations. The key is knowledge and skill through the total value chain – from the forester to the craftsmen at the building site, and in particular for the architect and engineer.

The objective of the Leonardo da Vinci Pilot Project “Educational Materials for Designing and Testing of Timber Structures” – “TEMTIS” for short – funded by the European Commission is to increase the knowledge of the acting professionals by providing a comprehensive set of educational materials. The aim is in particular students and professionals in architecture and civil engineering, but also the continuing education of professionals as well as the interested public should find this material about timber engineering and wood technology useful. In a compact form its purpose is to ensure the erection of safe, reliable and durable buildings.



In addition to a fairly comprehensive documentation of successfully erected timber structures, presented as “case studies”, and a database of interesting timber buildings, two so-called “Handbooks” make up the core of this project. While “Handbook 1” deals with the basics of wood technology and timber engineering and presents an overview of the various topics, “Handbook 2” emphasizes the regulations and specifications of Eurocode 5 (EC5). This standard will be the basis for the design and erection of timber structures in Europe in the future. In addition to present the specifications of EC5 the design procedures are illustrated by some characteristic examples.

“Handbook 1” gives a brief overview of the history of timber structures in Chapter 1. Chapter 2 deals with the properties of wood and Chapters 3 informs about facts concerning structural timber – the basic product for engineering purposes. In order to obtain timber components of large dimensions, wooden parts need to be bonded by means of adhesives (Chapter 4). This enables the production of the most important timber engineering products, glulam (Chapter 5) and wood based panels (Chapter 6). Chapters 7-10 summarize the basics of timber structure design. Chapter 7 gives an overview about general issues and special facts concerning the verification process of timber structures. The main topic of Chapter 8 is the behaviour of timber structures in the serviceability limit state (SLS), while the following two chapters deal with aspects of the ultimate limit state (ULS) for cross-sections and members (Chapter 9) and joints (Chapter 10). Chapters 11-15 contain basics and useful information about planar (Chapter 11) and spatial (Chapters 12) timber structures, timber house framing (Chapter 13), bracings (Chapter 14) and timber bridges (Chapter 15). In the subsequent chapters the important questions about durability (Chapter 16), fire resistance (Chapter 17) and the properties of timber in aggressive environments (Chapter 18) are described and discussed.

It is the wish and hope of all persons involved in preparing Handbook 1 that this publication will provide students and professionals in architecture and civil engineering with a solid basis for the design and understanding of exiting, reliable, cost effective and durable timber structures. We also hope that the handbook may promote quality of timber buildings and increase the use of this unique and sustainable material in the future.

Finally, the leader of working package WP3 – Handbook 1 – wishes to express his thanks to all contributors (see included list of contributors) and to all those unmentioned “helping-hands” in the background, for their efforts. Thanks also goes to Ms. Marcela ZAHNAŠOVÁ, University of Ostrava / Czech Republik for her unrelenting administrative work and her patience with the partners during this project, and to Mr. E.V. MÜLLER, University College Vitus Bering / Denmark for vetting the language of this handbook.

M. AUGUSTIN
Graz, September 2008



Chapter No. 1

HISTORY OF TIMBER STRUCTURES

1 Introduction

Timber has been available as a construction material for most societies since the human race first started to build crude shelters at the dawn of civilisation. A diversity of tree species exists and most climatic zones have at least one that has adapted to the prevailing conditions within that area. Thus, timber is generally available in most inhabited regions of the world. The history and development of timber structures is an extensive topic. Timber has been used in the construction of buildings, bridges, machinery, war engines, civil engineering works and boats, etc., since mankind first learnt to fashion tools. Here it will only be possible to give some examples, generally limited to houses and bridges to illustrate this development. These examples will be restricted to the European experience.

2 Timber-framed houses

The following section deals with timber-framed houses typical of South, North, West and East Europe.

2.1 Earliest shelters

Primeval man – Homo sapiens neanderthalensis (120 000 – 40 000 BC) – did not live only in caves, but also in primitive shelters. The shelters constructed by primeval man were made of a framework of suitable tree branches (Fig. 1.1) interlaced with deciduous tree branches or covered with grass. The floor plan of these shelters was circular.

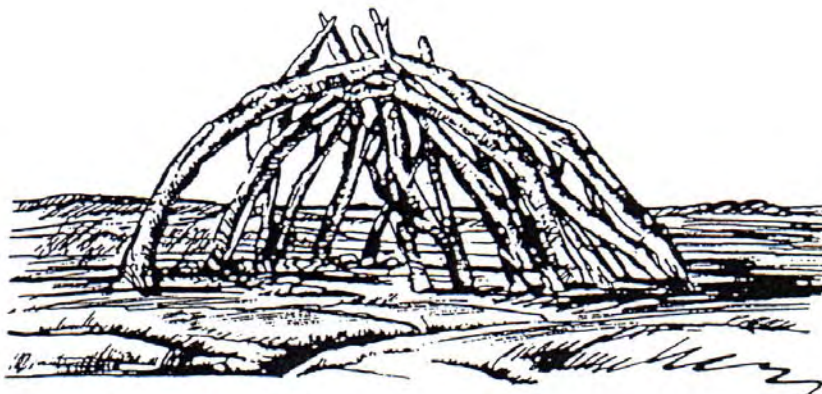

Fig. 1.1 The shelter framework of primeval man (120 000 – 40 000 BC)

European primeval man – Homo sapiens neanderthalensis probably died out during the last glacial period when Homo sapiens fossilis (40 000 – 10 000 BC), the descendant of Homo sapiens neanderthalensis, came to Europe from the neighbouring continents. The shelters constructed by Homo sapiens fossilis were made of a framework of tree branches covered by hides. These shelters were relatively large. In Moravia, archaeologists uncovered remnants of shelters with floor dimensions of up to 15 m x 9 m. The floor plan of these shelters was usually elliptical. The reconstruction of one of three shelters discovered in Ostrava City is shown in Fig. 1.2. The length of this shelter was approximately 7 m.

2.2 First timber-framed houses

The first timber-framed houses were constructed by the first farmers between 4 500 – 3 000 BC. The durability of these houses did not usually exceed twenty years. Since the first farmers did not know structural detailing well, they had many problems, particularly with trusses and bracing. In addition, they did not know carpentry joints well. Nevertheless, they constructed a longhouse. The reconstruction of the longhouse is illustrated in Fig. 1.3.

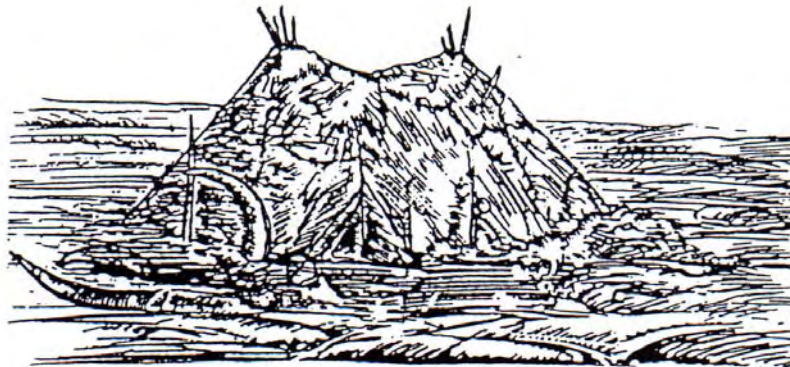

Fig. 1.2 Primeval mankind shelter (40 000 – 10 000 BC)

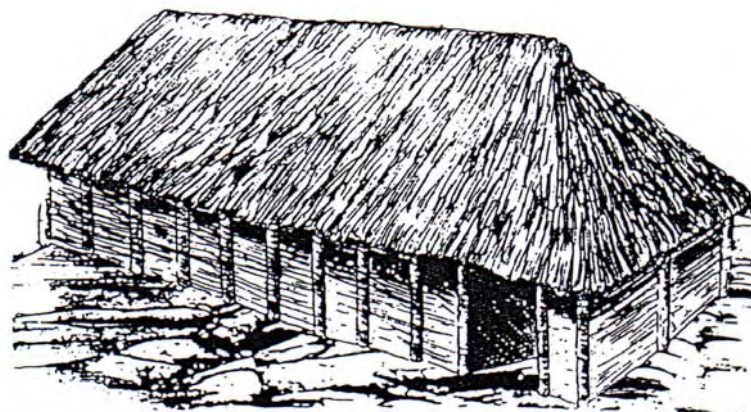

Fig. 1.3 Longhouse (4 500 BC)

The structure of all longhouses was the same. The width, ranging from 5.5 m to 7 m, was given by structural possibilities. The difference was only in the length, which varied from 20 m to 45 m. The rear gable of the longhouse was usually oriented to the north or in the direction of prevailing wind.

Longhouses were usually constructed on a gentle slope with the part for animals oriented down the slope. They did not have windows because the first farmers were not familiar with their construction and did not have glass or any similar material.

The framework of the longhouse was made by five lines of logs set in the ground. The logs supported the purlins, which carried the rafters.

The outside lines of the logs were interlaced by deciduous tree branches, which were smeared with clay. Roofs were probably covered by sedges. The floor plan of longhouses uncovered by archaeologists 30 – 40 cm under the ground in the village of Bylany is shown in Fig. 1.4.

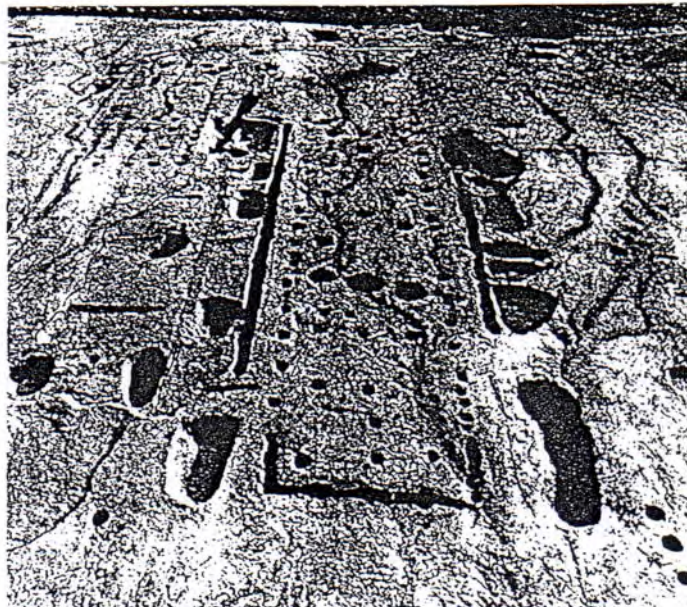

Fig. 1.4 Floor plan of longhouses in the village of Bylany (4 500 BC)

The floor plan reveals a mesh of hollows, which mark the position of the logs and fireplaces. Outside the perimeters of these longhouses are big trenches from which clay for wall smearing was taken. These big excavations were later used as waste disposal sites.

In 3 000 BC, longhouses constructed by farmers had very similar framework to the longhouses of the first farmers, only the floor plan of the latter was a little trapezoidal (Fig. 1.5).

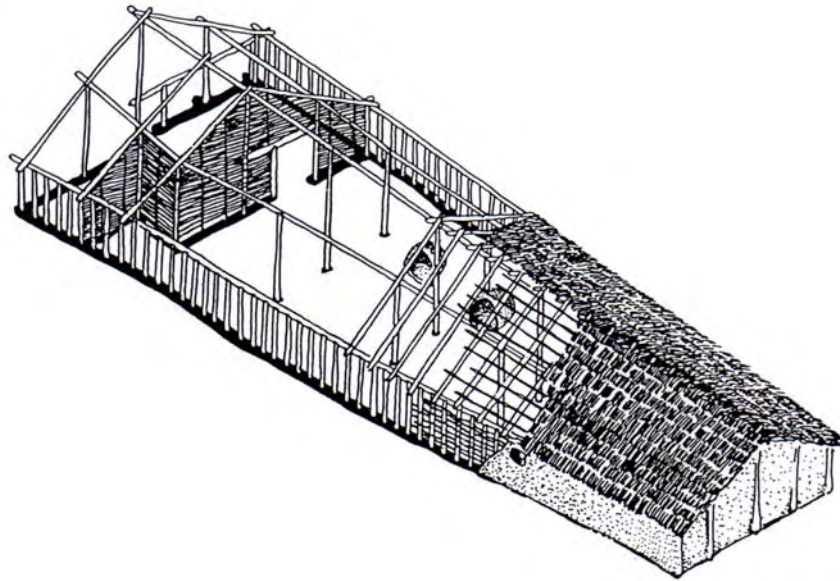

Fig. 1.5 Longhouse (3 000 BC)

In 400 BC, the Celts inhabited the territory of the Central Europe. One of the tribes gave its name to a province of the Czech Republic, Boiohaemum (Bohemia). Houses constructed by the Celts were light with a stone pedestal. The reconstruction of a house from the middle part of a Celtic stronghold, uncovered by archaeologists in Hrazany, is shown in Fig. 1.6 .

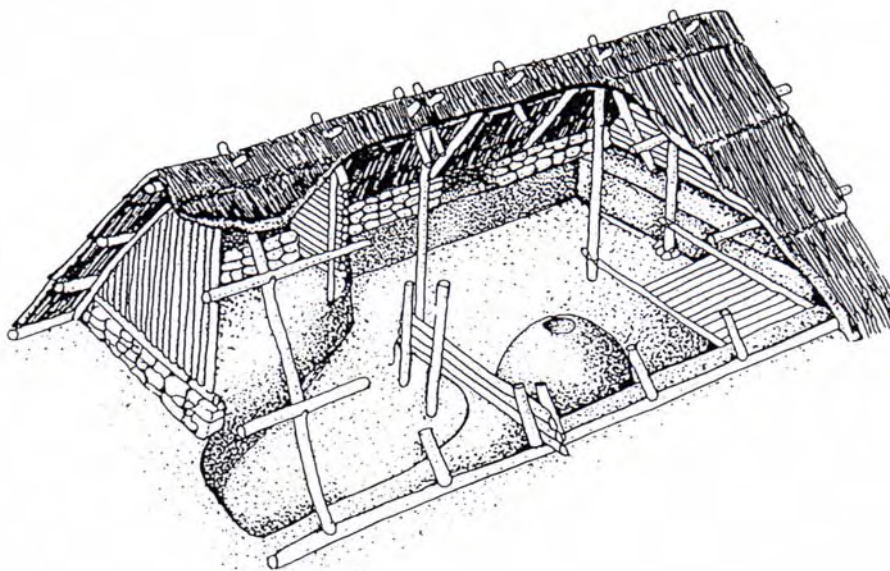

Fig. 1.6 House constructed by the Celts (400 BC)

This type of house was used in Central and Eastern Europe over centuries.



In the time of the Roman Empire, Teutons mainly occupied the territories of the Central Europe.

Houses constructed by the Teutons were primitive and small. Dimensions of floor plans were approximately 5 m x 6 m or 4 m x 5 m. Reconstruction of this type of house is shown in Fig. 1.7 .



Fig. 1.7 House constructed by the Teutons (0 – 500 AD)

Between 400 – 550 AD, the first Slavs came to the territories of Central Europe. Houses constructed by the Slavs were the same as the houses constructed by the Celts. At the beginning of the Middle Ages, this type of house was gradually replaced by a log house, particularly in towns. In the countryside, this type of house was subsequently erected.

From the 13th century onward, townhouses were different from houses in the countryside.

2.3 Rural houses

Between the 13th and the 15th century, rural architecture came into existence and in this form existed until the 19th century.

Between the 13th and the 15th century, rural architecture took on different regional forms (Fig. 1.8). Materials traditionally used at that time were timber, stone and clay.

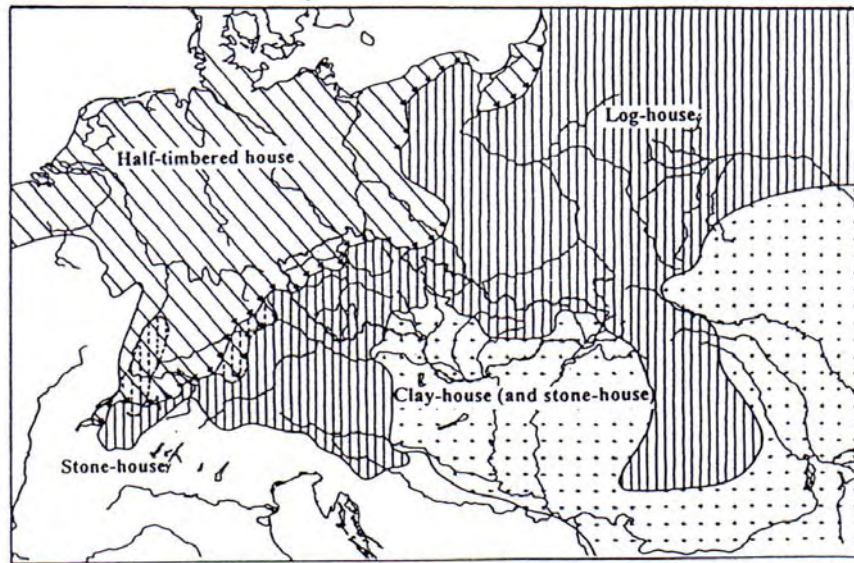

Fig. 1.8 Basic types of rural houses

Stone was mainly used for foundations and the structures under the ground. Stone was also used for walls from the time when the fireplace was moved from the centre to the corner of the house.

Clay came into use as a structural material in the 15th century.

In thickly forested regions of Central and Eastern Europe, a different house building technique developed using the almost unlimited supply of logs (predominantly round logs) in which they were usually laid horizontally, one upon the other to form walls. Structural stability was provided by notching the logs at the corner intersections so that the wall planes interlocked (Fig. 1.9).

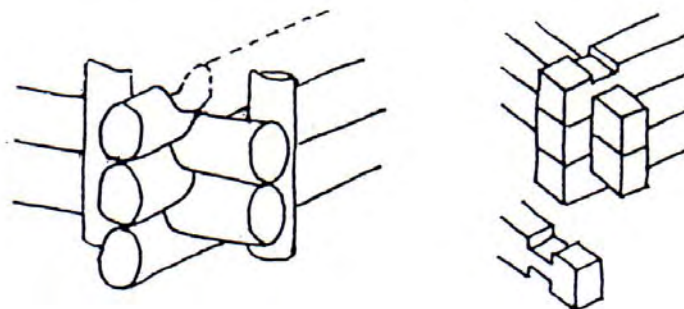

Fig. 1.9 Details of log house corners

Evidence of the use of this notching technique dates back to the Stone Age.

In Western Europe, a more sophisticated variation developed using trimmed logs with dovetail notches at corners (Fig. 1.10).

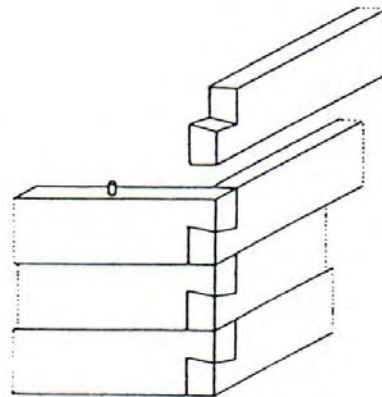

Fig. 1.10 Dovetail notches

In Western Europe and some parts of Central Europe, a half-timbered house building technique was developed using short logs (Fig. 1.11). Inexpensive local materials (mainly clay) were used as nogging.



Fig. 1.11 Half-timbered wall

This technique was developed in Germany in the 12th century and, at first, it was used in town houses. At the beginning of the 15th century, this technique was also used in rural houses.

Sometimes, the house structure was a combination of the log house and the half-timbered house techniques.

Roof structures of rural houses were very simple, dependent on snow loading. Bracing was usually constructed only in the longitudinal direction (Fig. 1.12).

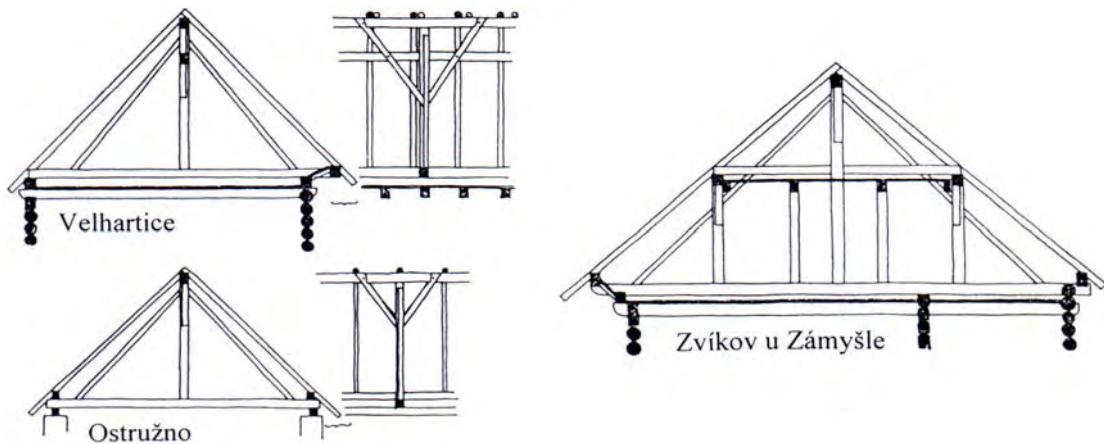

Fig. 1.12 Roof structures

2.4 Urban houses

During the 12th and the 13th century, the log cabin was widely built in towns of Central Europe. In contrast to the house in the countryside, there was only a passage leading to the backyard.

From the 14th century, stone and brick were used as structural materials for the construction of houses in towns. The main reason for their spread was fire resistance of these materials. Floor structures of urban houses were made of timber until the 16th century. These structures are shown in Fig. 1.13.

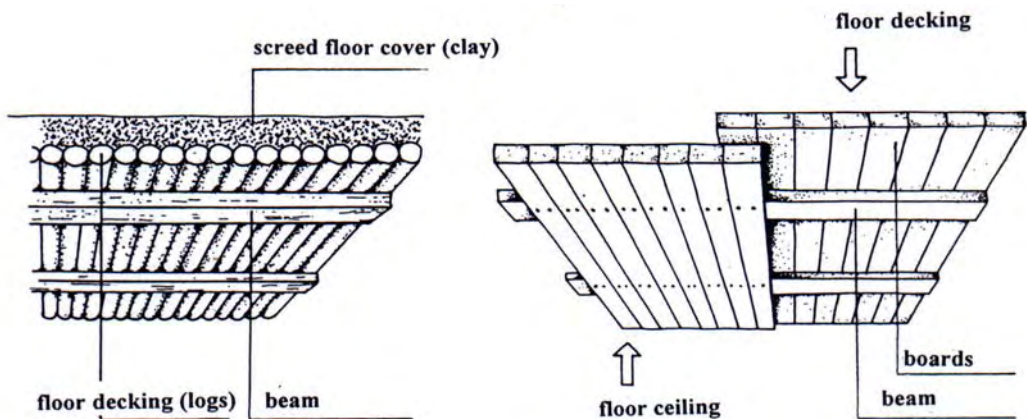

Fig. 1.13 Floor structures

Roof structures have been made of timber up to the present day. Since the 14th century, non-combustible roofing has been in use.

The development of urban houses was more specific than the development of rural houses. One of the reasons was the colonisation of towns by people from different parts of Europe. Layouts were usually rectangular in the plane with dimensions of 10 m x 30 m. A simplified development of an attached townhouse from the 12th century to the 15th century is shown in Fig. 1.14. The roof structure resembled the roof structure of rural houses.

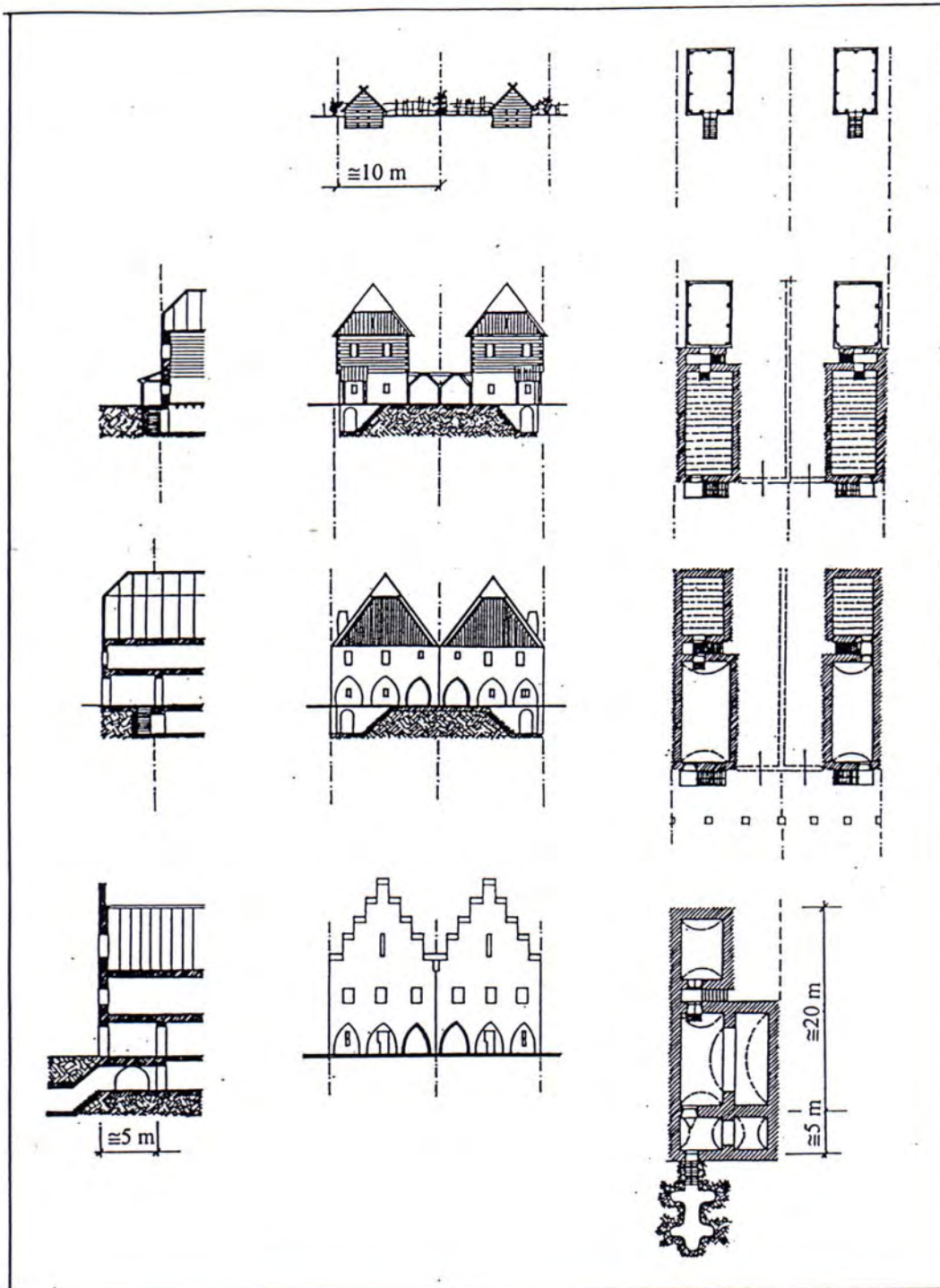

Fig. 1.14 Development of attached house

From the 16th century, urban houses were made predominantly from brickwork.

From the 18th century, it was prohibited to use timber as a building material in towns, except for floors, separating walls and roofs.

3 Timber bridges

The oldest known timber bridges go back to 600 BC. The limited information available on these bridges shows the builders to have had excellent knowledge of the properties of timber and their applications to structural forms. Whilst masonry bridges have survived for many centuries, these early timber bridges were mainly destroyed by war, natural disasters or fire.

Early timber bridges constructed by the Romans were simple beam structures of hewn tree trunks spanning between timber piled piers. One of the earliest recorded is the Pons Sublicius (Fig. 1.15), built during the time of Ancus Marcius (640-616 BC), which survived with regular repair until the time of Constantine (306-337 AD), over 900 years later.

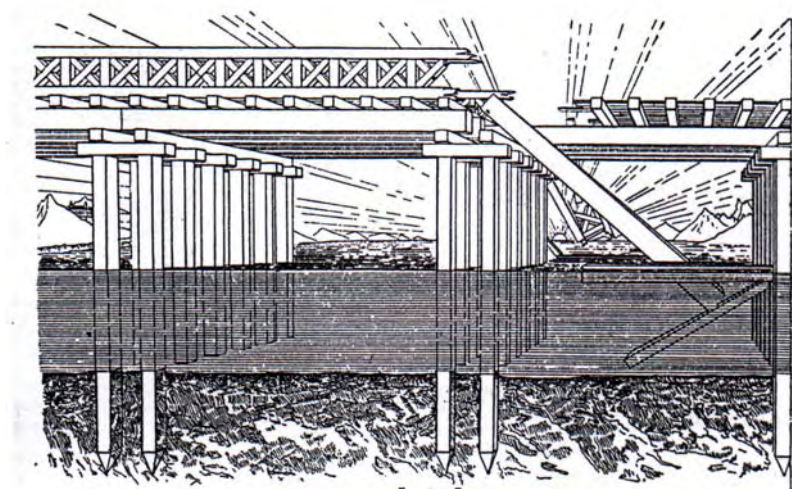

Fig. 1.15 Bridge Pons Sublicius

The bridge known as Caesar's Bridge (Fig. 1.16) across the Rhine, is believed to have been built under the direction of Vitruvius (the Emperor's Chief of Artillery) and, in a later drawing by Palladio, is shown to have longitudinal beams resting on crossbeams supported by inclined piles. An interesting joint was used to connect the piles and crossbeams so that the addition of load to the bridge deck caused the joint to become tighter.

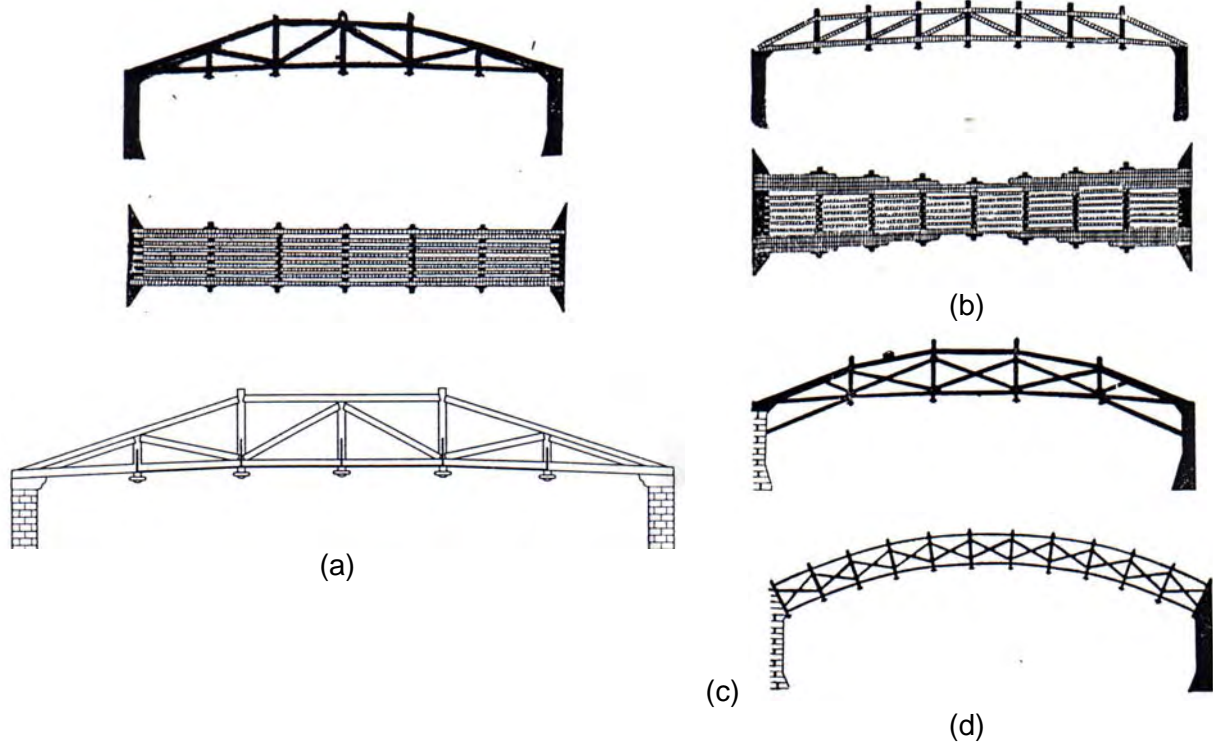

Fig. 1.18 Palladio's design for trussed bridges

One of the oldest timber bridges in existence in Europe is the Kapellbrücke (Fig. 1.19) in Luzern. It was built in 1333 and, over the centuries, much of the structure was rebuilt. Originally, the overall length was 285 m, but in the 19th century, this was reduced to 222 m. The bridge is covered and is formed of simply supported beams on interconnected timber piles. In August 1993, a large part of the bridge was destroyed by fire.



Fig. 1.19 Kapellbrücke



The rebuilding of the bridge following the original design began immediately, and the bridge was reopened for pedestrian use in April 1994. The supporting structure mainly consists of oak piles driven into the bed of the river Reuss. Cross-girders, again of oak, connect the pile caps and support the 26 spans of the main bridge structure; the average span is 7.65 m and the maximum span is about 13.5 m; the total length is now 204 m.

Between 1755 and 1758, the master carpenter Hans Ulrich Grubenmann built the well-known Rhinebridge at Schaffhausen (Fig. 1.20). He designed the bridge as a single span of 119 m but was forced by the town authorities to change the design and incorporate the existing central pier into the bridge. Shortly after the completion of the bridge, he removed packing members over this pier and was able to demonstrate that his original concept had been possible.

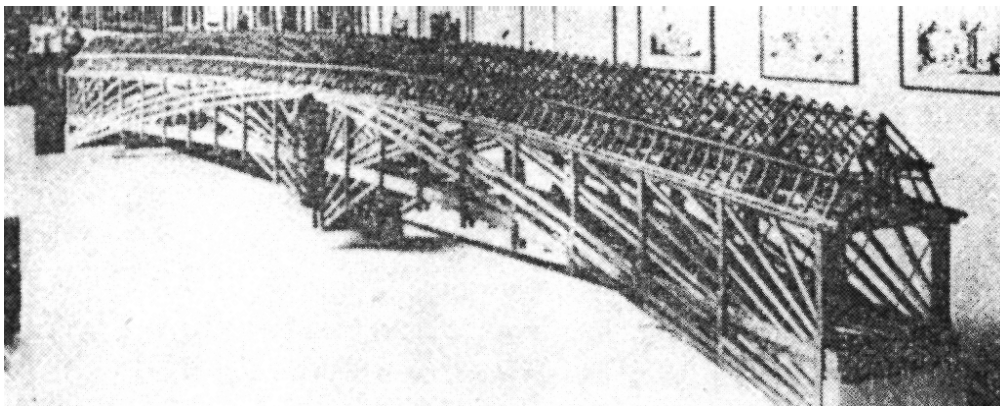

Fig. 1.20 Model of Rhinebridge

During the dramatic period of railway expansion in the 19th century, many bridges and viaducts were constructed in timber.

The British engineer I. K. Brunel (1806-1859) was a great believer in the structural use of timber and incorporated many timber structures in his London to Bristol Railway. However, in timber bridging he is best known for his railway viaducts built mainly in South West England and the Welsh valleys. On the main line route through Cornwall, there were 43 viaducts with aggregate spans of 8 km built between 1850 and 1859. These were slender, graceful structures often built on sweeping curves to bridge the deep valleys of the area at heights of up to 50 m. The viaducts followed a number of standard designs mainly incorporating fan like supports. The main beams used 300 mm by 300 mm section of yellow pine. They were often mechanically laminated using Brunel's special "joggle" or shear key to achieve greater spans. A special feature of the designs was that any structural member could be replaced within about an hour without disruption to service. The timbers were expected to last 30 years but as labour costs for maintenance increased, the bridges were replaced and most had gone by 1940.



4 References

- [1] Ebinghaus, H.;
“Das Zimmerhandwerk“,
Leipzig / Germany, 1939

- [2] Kuklík P.;
“Development of timber framed houses in Central Europe“,
Workshop COST Action E5, IUAV University, Venice/Italy, 2000

- [3] Mencl, V.;
“Country architecture“,
Prague/Czechoslovakia, 1980 (in Czech)

Chapter No. 1 has been prepared by Petr KUKLÍK, Department of Steel and Timber Structures, Czech Technical University in Prague / Czech Republic.



Chapter No. 2

WOOD PROPERTIES

1 Introduction

The trunk is of primary interest to the structural engineer as it is from the trunk that structural timber is milled. In order to understand the behaviour and limitations of timber, some basic information and understanding of wood from the trunk is necessary. Fig. 2.1 shows a cross section of a trunk indicating its main features in a growing tree.

Bark	The outer layers protect the trunk from fire, temperature, injury. The inner layers transport nutrients from leaves to growth areas.
Cambium	The growth centre where new wood cells are formed. New wood cells grow towards the inside and the new bark grows towards the outside of the cambium.
Sapwood	New cells that form vertical conduits for water and nutrients from roots to leaves. Cell walls are still growing inwards, and are laden with starches for their own growth.
Heartwood	Cells in the heartwood have stopped growing and form receptacles for waste products (extractives). This is older, and often harder wood, although it is not necessarily stronger.
Extractives	By-products of growth reactions that are stored in cells of the heartwood. The actual composition of the extractives varies from species to species and in the minor elements, from tree to tree. Some extractives are toxic to fungi and some insects.
Juvenile wood	This is the first wood laid down by the tree very early in its growth and is, therefore, near the centre of the tree. It tends to be inferior in density and cell structure. Generally, juvenile wood is a very small part of the cross section except in rapidly grown plantation grown timber.
Pith	The very centre of the trunk is the thin dark band that once was a twig or shoot.

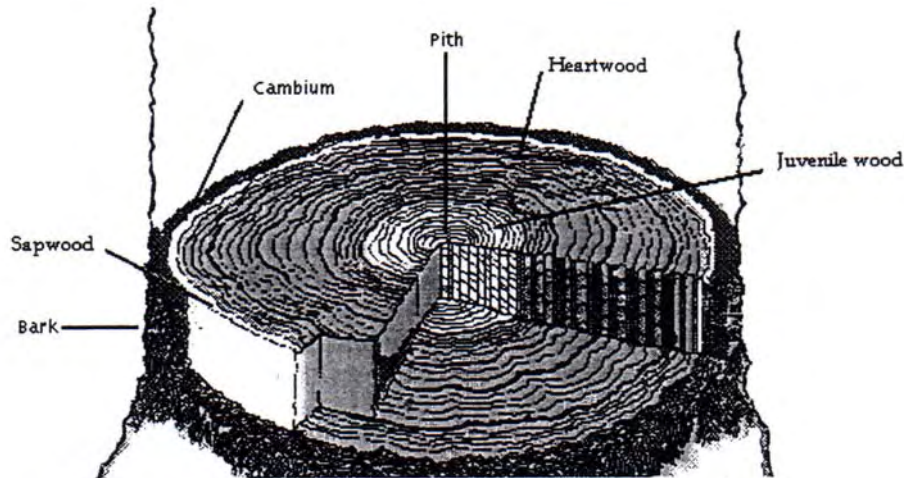

Fig. 2.1 Cross section of tree trunk

Wood is a natural, organic cellular solid. It is a composite made out of a chemical complex of cellulose, hemicellulose, lignin and extractives. Wood is highly anisotropic due mainly to the elongated shapes of wood cells and the oriented structure of the cell walls. In addition, anisotropy results from the differentiation of cell sizes throughout a growth season and in part from a preferred direction of certain cell types (e.g. ray cells).

The minute structure of cell walls, the aggregation of cells to form clear wood and the anomalies of structural timber represent three structural levels which all have a profound influence on the properties of wood as an engineering material. For instance, the ultra-structure level of the cell wall provides the explanation of why shrinkage and swelling of wood is normally 10 to 20 times larger in the transverse direction than in the longitudinal direction. The microstructure of clear wood holds the key to understanding why wood is 20 to 40 times stiffer in the longitudinal direction than in the transverse direction. The macrostructure of knots, fibre angle etc. provides the explanation of why tensile strength along the grain may drop from more than 100 N/mm^2 , for clear wood, to less than 10 N/mm^2 for structural timber of a low quality.

2 The structure of wood

Wood is obtained from two broad categories of plants known commercially as hardwoods (angiosperms, deciduous trees) and softwoods (gymnosperms, conifers) (Fig. 2.2).

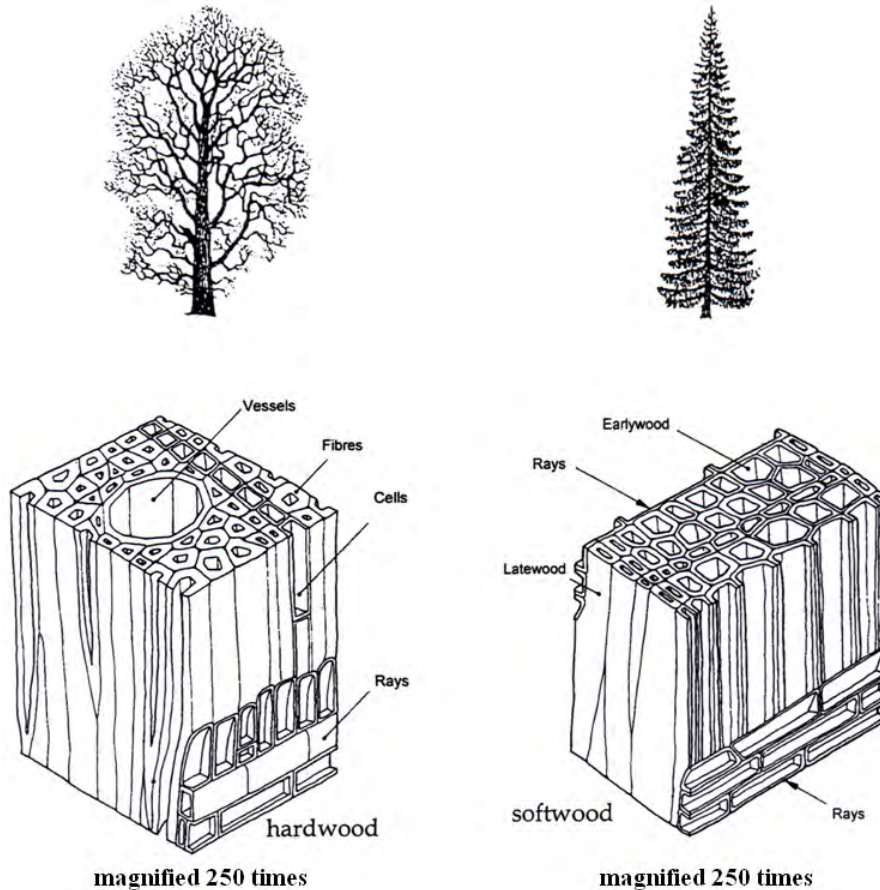

Fig. 2.2 Commercial timber is obtained from hardwoods (angiosperms) or from softwoods (gymnosperms)

The observation of wood without optical aids shows not only differences between softwoods and hardwoods and differences between species, but also differences within one specimen, for example sapwood and heartwood, earlywood and latewood, the arrangement of pores and the appearance of reaction wood. All these phenomena are the result of the development and growth of wood tissue.

Wood itself is fibrous. Cells are long and slender and are aligned with the long axis of the trunk. It is these fibres that give the grain in the wood, not the growth rings. They also make the properties of wood quite anisotropic with much higher stiffness and strength parallel to the grain than across the grain. We can liken the structure of wood to a bunch of parallel straws (representing the fibres or grain of the wood), which are bonded together using a weak glue.

When load is applied parallel to the axis of the straws (Fig. 2.3a), they are very strong in tension and have reasonably good compressive strength until they start to buckle. However, if the load is applied perpendicular to the axis of the straws (Fig. 2.3b), they will tend to crush under compression and are weakest in tension, where the "glue" bond fails and the straws literally tear apart.

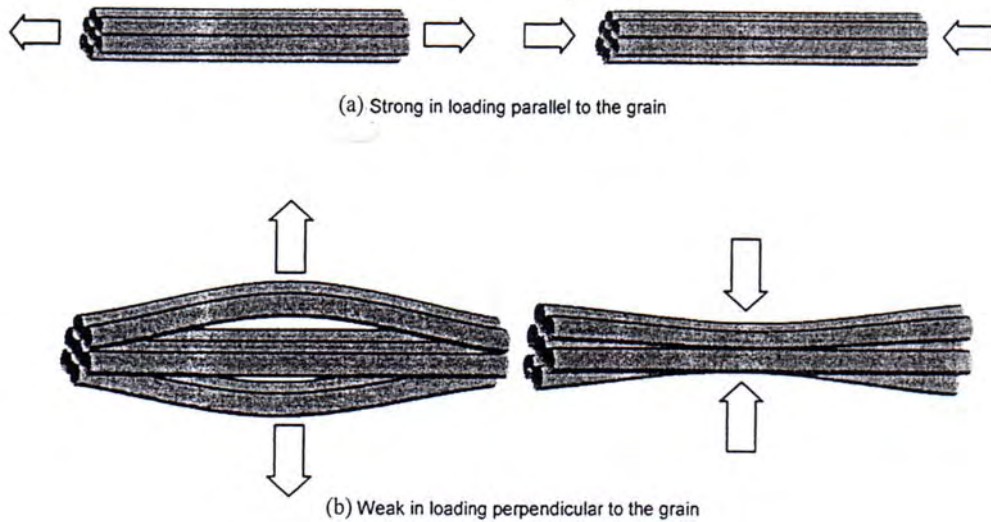

Fig. 2.3 Orthotropic nature of wood fibre

Many of the properties that interest civil engineers are functions of the microstructure of the wood:

Density	cell structure and size, moisture content
Strength	density, moisture content, cell size
Shrinkage	cell structure and size, moisture content
Stiffness	density, cell structure and size, moisture content
Colour	extractives
Fire resistance	density, extractives
Electrical resistance	moisture content, cell size

Mechanical damping cell structure



Softwood shows a relatively simple structure as it consists of 90 to 95 % tracheids, which are long (2 to 5 mm) and slender (10 to 50 μm) cells with flattened or tapered, closed ends. The tracheids are arranged in radial files, and their longitudinal extension is oriented in the direction of the stem axis. In evolving from earlywood to latewood, the cell walls become thicker, while the cell diameters become smaller. At the end of the growth period, tracheids with small cell lumina and small radial diameters are developed, whilst at the beginning of the subsequent growth period, tracheids with large cell lumina and diameters are developed by the tree. This difference in growth may result in a ratio between latewood density and earlywood density as high as 3:1.

Hardwood anatomy is more varied and complicated than that of softwood, but most structural concepts are analogous. Hardwoods have a basic tissue for strength containing libriform fibres and fibre tracheids. Within this strengthening tissue, conducting vessels are distributed, often with large lumina. These vessels are long pipes ranging from a few centimetres up to many metres in length and consisting of single elements with open or perforated ends. Diffuse-porous and ring-porous hardwoods can be distinguished by the arrangement of the diameter of the vessels. Hardwood fibres have thicker cell walls and smaller lumina than those of the softwood tracheids. The differences in wall thickness and lumen diameters between earlywood and latewood are not as extreme as in softwoods.

3 Growth rings

For most softwoods and ring-porous hardwoods there is a relationship between the width of growth rings and density. Softwoods tend to produce high density latewood bands of a relatively constant thickness. Most of the variation in growth ring width is caused by a variation in the thickness of the low density early wood bands. For most softwoods, therefore, density decreases with increasing growth ring width. This explains why ring width is included as a grading parameter in many visual grading rules currently used in Europe. However, caution should be exercised when using such relationships. The density level for a given ring width is dependent on soil type, climate conditions, silvicultural practice etc. Therefore, for softwood timber of mixed origin, ring width does not predict density with any real accuracy.

Ring-porous hardwoods such as oak and ash are characterized by a high concentration of open vessels produced during spring. The width of these rings is relatively constant and the variation in growth ring width is caused by a variation in the thickness of the high density latewood bands of fibre tracheids. This is why density increases with increasing ring width for most ring-porous hardwoods. There is no such relationship for diffuse-porous hardwoods such as poplar and beech.

4 Sapwood and heartwood

The young outer part of a tree stem conducts the upward flow of sap from the root to the crown. This part of the stem is known appropriately as sapwood. As the cells grow old, they stop functioning physiologically; this inner part of the stem is known as heartwood.



In most species, heartwood is darker in colour due to the incrustation with organic extractives. These chemicals provide heartwood with a better resistance to decay and wood boring insects. Normally, heartwood formation results in a significant reduction in moisture content. This results in pit aspiration. In many hardwood species, the vessels become plugged. This causes a marked reduction of permeability. In some species (e.g. spruce, beech) the heartwood is not coloured, nevertheless the extractives and physical alterations result in a difference between sapwood and heartwood.

For the purpose of wood preservation, sapwood is preferred, since the heartwood of a species such as pine (*Pinus sylvestris*) is virtually impermeable.

5 Juvenile and reaction wood

The wood of the first 5 to 20 growth rings (juvenile wood) of any stem cross-section exhibits properties different to those of the outer part of the stem (mature wood). This is particularly significant for softwoods. In juvenile wood, tracheids are relatively short and thin-walled.

Juvenile wood, therefore, typically exhibits lower strength and stiffness and much greater longitudinal shrinkage than mature, normal wood. Heartwood often holds all the juvenile wood, which possesses inferior quality with respect to mechanical properties. Therefore, in young, fast grown trees with a high proportion of juvenile wood, heartwood may be inferior to sapwood. Juvenile wood is not normally considered a problem in terms of timber engineering. However, with the increasing proportion of fast grown, short rotation plantation trees being used in the industry, the problems attached to juvenile wood will increase.

A tree reacts to exterior forces on the stem by forming reaction wood. Softwoods develop compression wood in areas of high compression, whereas hardwoods develop tension wood in high tensile regions. While the occurrence of tension wood is of minor importance to timber engineering, compression wood often creates problems. Compression wood has the appearance of wider growth rings and a higher latewood proportion than normal wood.

Timber containing compression wood is liable to excessive distortion upon drying. Compression wood is normally of higher density so there is no loss in mechanical properties. However, in a dry condition it tends to break in a brittle manner. Most visual strength grading rules limit the amount of compression wood in high quality grades.

6 Grain deviation

Some trees grow with a cell orientation forming a helix around the stem. This spiral grain is common in certain timber species and rare in others. It is particularly pronounced in young trees. Timber sawn from these trees often exhibits grain deviation which will severely impair its use. Limits to grain deviation are included in most visual strength grading rules; typically a grain deviation of 1 in 10 is accepted for high quality timber while 1 in 5 or more is accepted for low quality timber.

7 Knots

Knots are the parts of branches that are embedded in the main stem of the tree. The lateral branch is connected to the pith of the main stem. As the girth of the trunk increases, successive growth rings form continuously over the stem and branches and a cone of branch wood (the intergrown knots) develops within the trunk. Such knots are termed tight knots because they are intergrown with surrounding wood. At some points the limb may die or break off. Then subsequent growth rings added to the main stem simply surround the dead limb stub and the dead part of the stub becomes an encased knot. It is not intergrown and often has bark entrapped and is called a loose knot.

Softwoods are characterized by having a dominant stem from which whorls of lateral branches occur at regular intervals or nodes. Softwood boards therefore show knots in clusters separated by the often clear wood of the internodes. Knots are, by far, the single most important defect affecting mechanical properties. Knots are termed according to their appearance at the surface of the timber (Fig. 2.4).

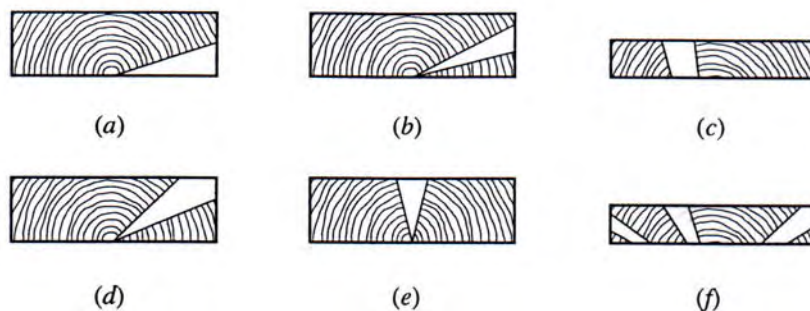

Fig. 2.4 Knots are termed according to their appearance at the surface of the timber: (a) spike knot; (b) narrow face knot; (c) through knot; (d) arris knot; (e) wide face knot; (f) knot cluster

8 Density

Density is the most important physical characteristic of timber. Most mechanical properties of timber are positively correlated to density as is the load-carrying capacity of joints. Limits to density are, therefore, incorporated directly in the strength class requirements of EN 338 “Structural timber – Strength classes”.

Density is defined as

$$\rho = \frac{m}{V} \quad (2.1)$$

where

m is the mass (kg) of timber and V is volume (m^3).

Density is moisture dependent, because moisture adds to the mass and may cause the volume to swell.



Density ρ_ω at a moisture content, ω (%), is expressed as

$$\rho_\omega = \frac{m_\omega}{V_\omega} = \frac{m_0 (1 + 0.01 \omega)}{V_0 (1 + 0.01 \beta_V \omega)} = \rho_0 \frac{1 + 0.01 \omega}{1 + 0.01 \beta_V \omega} \quad (2.2)$$

where m_0 , V_0 and ρ_0 are the mass, volume and density at zero moisture content. ρ_0 is termed oven-dry density or simply dry density. β_V is the coefficient of volumetric swelling and has the units of percentage swelling per percentage increase of moisture content.

As explained in detail later, swelling only occurs when water is penetrating the cell wall layers. The moisture content corresponding to saturation of the cell wall is termed the fibre saturation point ω_f . This corresponds to a moisture content of about 28 %. Above this no swelling occurs. Below fibre saturation, swelling may for practical purposes be considered linear with moisture content.

In wood science and engineering, dry density ρ_0 and density ρ_{12} at 12 % moisture content are most frequently used. Density values given in EC5 are defined with mass and volume corresponding to an equilibrium at a temperature of 20 °C and a relative humidity of 65 %.

The values of ρ_{12} referred to in EC5 relate to the average density $\rho_{12,mean}$ and the characteristic density $\rho_{12,k}$ defined as the population 5-percentile value. For a given strength grade of timber, density is assumed to show a normal distribution with a coefficient of variation of 10 %. Therefore:

$$\rho_{12,k} = \rho_{12,mean} - 1.65 (0.1 \rho_{12,mean}) = 0.84 \rho_{12,mean} \quad (2.3)$$

The density ρ_c of the cell wall is about 1 500 kg/m³. The density of wood, therefore, is dependent on its porosity, defined as the volume fraction of cell lumina. Structural timber typically shows dry density values in the range from 300 to 550 kg/m³, which gives fractional void volumes in the dry condition from 0.80 down to 0.63.

The density of timber, even of a particular sample taken from a single location, varies within wide limits. EN 338 “Structural timber – Strength classes” defines characteristic density values $\rho_{12,k}$.

9 Wood and moisture

Moisture content is defined as the ratio of the mass of removable water (m_w) to the dry mass (m_0) of the wood (Equation 2.4). The dry mass is obtained by oven drying at 103 ± 2 °C. Moisture content may be expressed as a fraction or in percentage terms. Throughout this chapter, wood moisture content is expressed in percentage terms:

$$\omega = \frac{m_w}{m_0} 100 = \frac{m_\omega - m_0}{m_0} 100 \quad (2.4)$$



For moisture contents in the range from 6 to 28 %, electric moisture meters are available, which are easy and quick to use. The accuracy of the best meters is of the order ± 2 % which is quite sufficient for practical engineering applications. The two principles currently in use are, firstly, a DC based measurement of the moisture dependent resistivity between two electrodes hammered into the wood and secondly, an AC based assessment of the moisture dependent dielectric properties of wood in an electric field created by two electrodes resting on the wood surface. Both types of meter require calibration and the AC meters only measure the moisture content in the top layer of the wood.

When wood is dried from a green condition, water is first lost from the cell lumens. This water is not associated at the molecular level with wood and is termed free water. The water held within the cell wall is termed bound water as it is held to the cell wall substance with hydrogen bonds and van der Waals forces. The removal of water from the cell wall thus requires greater energy than removal of free water.

The moisture content, ω_f , when the cell wall is saturated with moisture, but no free water exists in the cell lumen, is termed the fibre saturation point (FSP). The FSP for most species is in the range from 25 to 35 %; for most practical purposes 28 % is a convenient average.

The fibre saturation point is of a considerable engineering significance since below this point there will be dramatic changes in most physical and mechanical properties. Above the FSP most properties are approximately constant.

10 Shrinkage and swelling

Moisture has such an affinity to the wood cell wall substance that it can force its way into this virtually non-porous material. By so doing, it pushes the microfibrils apart. The resultant swelling of the cell wall can for practical purposes be assumed to be equivalent to the volume of the absorbed water. During swelling the volume of the cell lumens stays constant. This implies that the volumetric swelling of timber equals the volume of the absorbed water.

When moisture is removed from the cell wall, timber shrinks. Shrinkage and swelling within the normal moisture range for timber structures are termed movements.

Changes in dimensions tend to be linear with moisture in the range from 5 to 20 % moisture content. In this range movements may be calculated from

$$h_2 = h_1 \left[1 + \frac{\beta}{100} (\omega_2 - \omega_1) \right] \quad (2.5)$$

where h_1 and h_2 are the dimensions (thicknesses) at moisture contents ω_1 and ω_2 respectively. β is the coefficient of swelling (positive) or shrinkage (negative). Units are %/ %.

If no species-specific value of the coefficient of movement is known, an approximation may be used. The coefficient of volumetric movement β_v can be considered to be equal to the numeric value of the density times 10^{-3} . In other words, the volume of timber of a density equal to 400 kg/m^3 swells 0.4 % for each 1 % increase in moisture content. This is based on the volumetric swelling equaling the volume of water uptake. The coefficient of longitudinal



movement, β_0 , is usually negligible, in which case the coefficient of transverse movement, β_{90} , is equal to half the coefficient of volumetric movement.

For most species, including spruce, pine, fir, larch, poplar and oak, engineering values of β_0 and β_{90} can be taken as $\beta_0 = 0,01$ and $\beta_{90} = 0,2$, where β is given as percentage movement for 1 % change of moisture content. For dense species like beech (*Fagus sylvatica*) and ekki (*Lophira alata*), a $\beta_{90} = 0.3$ should be used.

In plywood, the movements in the panel plane are of the same order as the longitudinal movements of timber. For other composite wood products, such as particleboards and fibreboards, these movements are very dependent on the particular panel type and production technique. In the transverse direction of panel products, the reversible movements are of the same order as those of timber. However, many panel products, which have been subjected to high compression stresses during production, will show additional, irreversible thickness swelling or “spring back”.

When wood is restrained from expanding (e.g. in bolted joints), the uptake of moisture induces internal stresses. Due to the viscoelastic/plastic nature of wood, such stresses will eventually relax and irreversible dimensional changes occur. When wood returns to its original moisture content the dimensions have shrunk, and the bolted joint may then be a loose fit and have lost some of its capacity. It is therefore important in engineering design to retain access to such construction joints, which may need tightening up.

In order to minimize the problems of dimensional movements timber should preferably be used at a moisture content corresponding to the relative humidity of its environment. Within buildings, the timber with moisture content higher than 20 to 22 % should only be used as an exception and only in such cases where adequate and quick drying of the structure is obtained without risks of biological degradation or permanent set due to mechanosorptive creep.

11 Distortions

The anisotropy of transverse swelling may cause cross sections to distort upon drying (Fig. 2.5). The fact that tangential shrinkage is about twice the radial shrinkage explains the tendency for the growth rings to straighten out.

The internal stresses developed by the anisotropic shrinkage may be released primarily in the development of radial cracks. The tendency to cracking is more pronounced the larger the cross section and the faster the drying rate.

The presence of compression wood, juvenile wood or even knots in only a part of a cross section may cause lengthwise distortions known as bow, spring and twist. Twist may also result from sawing timber from a tree exhibiting spiral grain. Cup is the result of the different movements in the tangential and radial directions (Fig. 2.6).

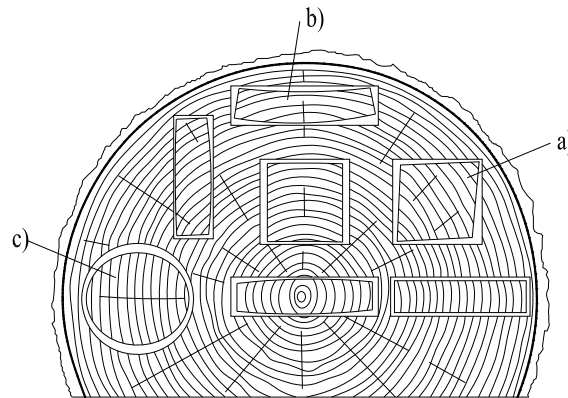

Fig. 2.5 Distortions of various cross sections after drying, cut from different locations in a log

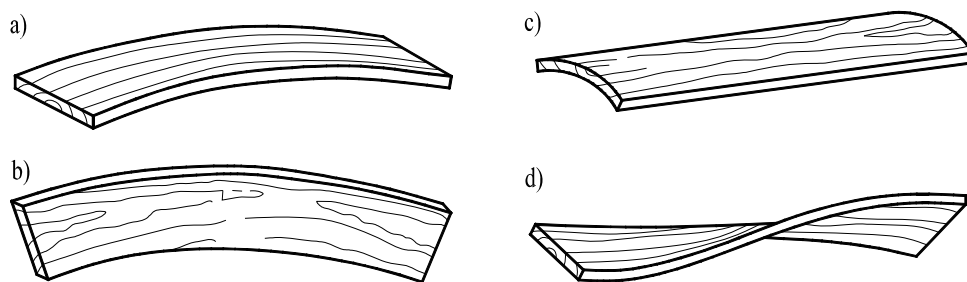

Fig. 2.6 Distortions: a) bow; b) spring; c) cup; d) twist

The degree of distortion is often given maximum limits in national strength grading rules. The EN standards for visual and machine strength grading contain recommended limits to distortion (Tab. 2.1). Such limits do not reflect an exact relationship between distortion and strength but rather define limits beyond which the handling and assembling of timber in structural components become unacceptably complicated. There may be occasions when the structural design calls for tighter limits than given in Tab. 2.1 and such limits then must be agreed with the producer.

Type of distortion	Grade fitting into strength class	
	C18 and below	Higher classes
Bow	20	10
Spring	12	8
Twist	2 mm/25 mm width	1 mm/25 mm width
Cup	No restrictions	

Tab. 2.1 Maximum distortion (mm per 2 m length) according to EN 518 and EN 519



12 Moisture content and mechanical properties

The mechanical properties of wood are dependent on moisture content. An increase in moisture produces lower strength and elasticity values. This effect is partly explained by the cell wall swelling, whereby less cell wall material per unit area is available. More important, however, is that water when penetrating the cell wall, weakens the hydrogen bonds responsible for holding together the cell wall. Moisture variations above fibre saturation point have no effect on mechanical properties, since such variations are related to free water in the cell lumens.

The effect of moisture change varies for different mechanical properties. For example, failure in compression parallel to grain is caused by fibre buckling where moisture sensitive hydrogen bonds play an important role and is more sensitive to moisture than tension strength, which also includes ruptures of covalent bonds when tearing apart the cell wall microfibrils.

When comparing mechanical properties, a standard reference moisture condition consistent with an environment of 20 °C and 65 % relative humidity is to be used for timber and wood based panels. For structural timber tested under a different condition, the mechanical properties must be adjusted in accordance with EN 384 “Structural timber - Determination of characteristic values of mechanical properties and density”.

13 Duration of load

Timber experiences a significant loss of strength over a period of time. The strength values to be used in design of timber members for long-term permanent loads are approximately only 60 % of the strength values found in a short-term laboratory test.

Moisture variations are known greatly to increase creep in timber. This effect is termed mechanosorptive because a fit is only apparent during the simultaneous mechanical stress and moisture sorption cycling. The mechanosorptive effect has been shown also to shorten the time to failure of timber.

Surface treated timber or glulam members of large volume experience a relatively less moisture variation than untreated timber or small volume timber. The evidence of a mechanosorptive effect suggests that surface treated timber and large volume glulam members should be allowed a more modest duration of the load modification factor.

The duration of the load behaviour of panel products varies within a very wide range. Structural plywood is considered to behave like solid wood. Particleboard behaviour is intimately linked to particle size and particle orientation, and for both particleboard and fibreboard, glue quality is of the utmost importance for the long-term properties. While the best particleboard products may be assigned a 0.40 duration of load modification factor for permanent loads, fibreboards may rate as low as 0.20.



14 Modification factors for moisture content and duration of load

In timber design, the influence of moisture and duration of load is taken into consideration by assigning timber structures to service classes and actions to load-duration classes. EC5 then defines modification factors, k_{mod} for each combination of the two classifications.

15 References

- [1] Boughton, G.N.;
"Introduction to timber design",
Chapter 1.0 from "LIMIT STATES TIMBER DESIGN to AS1720.1"; Curtin University,
Australia, 1997
- [2] Hoffmeyer, P.;
"Wood as a building material",
Chapter A4 from "STEP 1 – Timber Engineering"; First Edition, Centrum Hout,
The Netherlands, 1995

Chapter No. 2 has been prepared by Petr KUKLÍK, Department of Steel and Timber Structures, Czech Technical University in Prague / Czech Republik.

Chapter No. 3

STRUCTURAL TIMBER

1 Introduction

At the beginning of this chapter a statement by B. Madsen [1] is cited:

“... The two products – wood, in the sense of clear defect-free wood and timber, in the sense of commercial timber – have to be considered as two different materials and that must be respected when strength properties are developed for engineering purposes. ...”

This statement reflects the most important fact when structural timber is applied as an engineering material for building purposes. As the denotations “wood” and “timber” already indicate, they assume that the mechanical behaviour and properties of “clear-wood”, with its mechanical values originally tested and prepared for the utilization in machine and aircraft engineering, differs considerably from the behaviour and properties of full-size members in dimensions used for building engineering purposes. Apart from the size-effect, i.e. specimens with smaller dimensions have higher strength values than specimens of larger dimensions, an explanation can be found in the occurrence of “structural disturbances“ (growth characteristics) like knots, slope of grain, cracks etc., but also as a result of the production process (e.g. cut fibres through sawing, etc.), which are usually apparent in full-size members.

The mechanical values, and in some cases the mechanical behaviour, of these two “materials“ have to be distinguished strictly. Figure 3.1 illustrates the deviating dimensions and material structure by means of tensile test “clear-wood“ and timber specimens. Its evident that test results obtained from the shown specimens will differ.

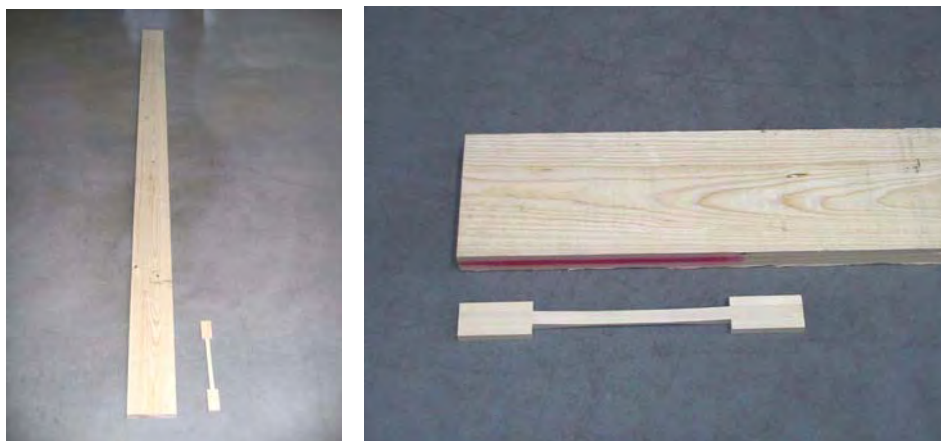

Fig. 3.1 Test specimen for tensile tests; full-size vs. clear-wood specimen

From the European viewpoint of timber engineering, design values for strength and stiffness of structural timber have to be tested on full-size specimens. However, mechanical characteristics for timber, e.g. in North America, were deduced from tests on small sized "clear-wood" specimens and subsequent adaptation of the mechanical values by different factors for a long time. This leads to the fact that when constituting mechanical values for structural timber one should better speak from "engineering" than from "material" design values.

2 Grading

Wood is a natural resource with a wide range and high dispersing of physical and mechanical properties depending on species, genetics, growth and environmental conditions of the tree. To be able to utilise the potential of given properties and use it as a load carrying member in an effective and reliable way, timber has to be graded. Depending on the use of the product, the grading process can be done with respect to:

- strength
- appearance
- "end-use" (i.e. form stability, cracks, twist etc.)

Table 3.1 gives an overview on selected "structural disturbances" (growth characteristics) of wood and timber respectively and their relevance in grading.

Type of structural disturbance (growing characteristics)	Consequence for			
	Strength	Stiffness	Durability	Appearance
Knottiness (incl. grain deviation in the knot area)	+	±	–	+
(Global) Slope of grain	+	–	–	–
Reaction Wood	+	±	–	+
Annual ring pattern / - position	(–)	(–)	(–)	+
Biological damage (Insects, fungi)	(+)	(+)	+	+
Mechanical damage	+	(–)	–	(–)
Cracks	(+)	(+)	(+)	(–)
Deformations, twist	–	+	–	+

Abbreviations:
+ strong influence, (+) significant influence, ± medium influence, (–) small influence, – no influence

Tab. 3.1 Overview about some "structural disturbances" (growing characteristics) and their influence on grading for different purposes [5]



For the utilisation as load carrying members, it is self-evident that strength and stiffness grading is the most important grading aspects. This can be done by two methods:

– Visual strength grading

The visual strength grading method is based on the correlation of the occurrence, the size and type of growing characteristics, e.g. the size of a knot and the mechanical properties. In general it is done manually by skilled persons. Simple and easy to learn rules, which are nationally defined, are specified for the classification into different strength classes. Currently the European standard EN 14081, Part 1 defines only minimum requirements for the development of grading standards. The following characteristics should be defined in this code as a minimum:

- Limitations for strength reducing characteristics: knots, slope of grain, density or rate of growth, cracks
- Limitations for geometrical characteristics: wane, distortion (bow, spring, twist)
- Limitations for biological characteristics: fungal and insect damage
- Other characteristics: reaction wood, mechanical damage.

The advantages and disadvantages of visual strength grading are:

- Rules are simple, easy to understand and application does not require great technical skills and expensive equipment
- It is labour intensive and inefficient because the wood structure and density, which are important parameters for the strength, cannot be considered, only estimated.
- Grading results depend on the attention and skills of the persons responsible for grading; therefore the capacity and objectivity is limited.
- If the rules are applied correctly, the method is effective and cheap.

Specifications for the allocation of national visual grading classes to the system of strength classes given in EN 338 can be found in the European standard EN 1912.

– Machine strength grading

In the course of machine strength grading, in addition to the parameters for visual grading, also the main strength influencing wood parameters density and modulus of elasticity are taken into account. As a consequence timber can be graded with higher reliability and utilised more effectively.

The process is done by machines, which are commonly based on the following physical principles:

- Mechanical principles (bending machine, proof-loading)
- Vibration principles (measurement of the dynamical MOE by means of longitudinal vibrations (“eigenfrequency”) and ultrasonics)
- Radiographic principles (X-ray measurement, microwaves)
- Optical principles (CCD-cameras, measurement of the “tracheid-effect“)
- Others (heat capacity measurement, impact measurement, etc.)

Advantages and disadvantages of machine strength grading are:

- Grading is repeatable and objective, which leads to a greater predictive accuracy and higher yields in higher strength classes
- Grading performance can be increased (up to a capacity of 300 m/min)
- The equipment is expensive, the implementation only making sense for companies with big production capacity. Machines have to be maintained and repaired, further machines and/or products have to be extensively controlled by internal and external supervision.
- Persons who supervise the grading process have to be well trained.
- Currently, only devices for smaller dimensions are approved.

Specifications for machine grading can be found in the series of the European standard EN 14081 series (Part 1,2,3 and 4).

The strength grading process leads to more homogenous and graduated mechanical properties and enables the definition of classes based on grading classes (see Fig. 3.2). For the European strength class system given in EN 338, characteristic values for softwood (coniferous ... C) and hardwood (deciduous ... D) wood species are tabulated.

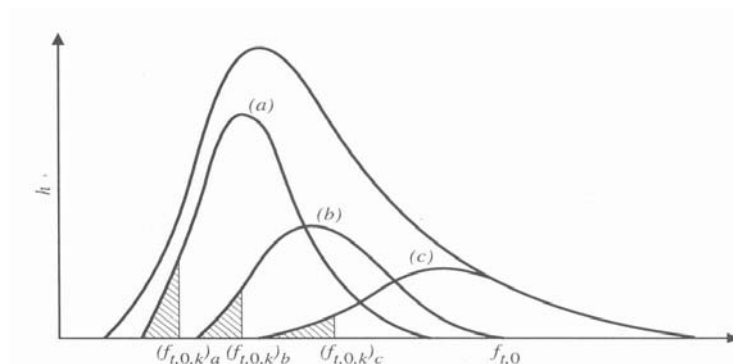

Fig. 3.2 Scheme of tensile strength distribution of structural timber assigned to three grades a, b, c; [2]



3 Mechanical properties

Characteristic for structural timber is its anisotropic nature, where the natural wood structure will be remained to a high degree. This is not the case for “engineered wood products”, which are more or less homogenous with respect to material behaviour and values.

The above is a consequence of the elementary processing steps during the production of structural timber:

- debarking
- sawing
- drying
- planing (if necessary)
- finger-jointing (only for some products)
- gluing on the broader side (only for some products; but less than four members)

Apart from the differences mentioned for wood and timber at the beginning of this chapter, the physical properties concerning anisotropic behaviour, shrinkage and swelling, duration of load etc., are the same as for wood explained in Chapter 2.

It has to be noted that the characteristic values given in this table are linked to reference dimensions (for solid timber: width $b = 150$ mm for tensile strength, height $h = 300$ mm) because of the “size effect”. For other dimensions within the design process, factors k_b and k_h respectively can be taken into account which considers this effect.

4 Products

4.1 Poles and round-timber

- General

For the products “Poles and round timber”, only the debarking process and sometimes a cut along the longitudinal axis to reduce the effect of shrinkage and swelling is admissible. The injury of the natural fibre structure, e.g. by changing the cross section, has to be avoided. As a result, an increase of the bending and tension properties as well as for the MOE of about 20% compared to sawn timber can be achieved.



– Mechanical properties

Because of practically reasons in addition to the influences of growing characteristics on the mechanical properties (like size and amount of knots, slope of grain, etc.) limit values for:

- the taper (diminishment of the dimensions of the cross section along the longitudinal axis),
- twisted grained due to spiral grow of the tree and
- the ovality (proportion of the maximum to the minimum dimension of the cross section)

have to be considered when using poles and round timber for load carrying members.

– Dimensions

Length: up to 20 m (depending on the transportation and assembling possibilities)

Diameters: From small diameters (80 mm) up to 500 mm depending on wood species

– Application

Poles and round timber is almost exclusively utilized for longitudinal loaded members as used for columns and struts for trusses. Poles and round timber are often used for agricultural buildings, bridges for wood harvesting and generally buildings in the landscape; such as telephone poles, for scaffolds and also as piles for the foundation of buildings. The product is cheap and easy to organize while it has disadvantages in the design and in particular the design of joints (durability).

– Wood species

All kinds of available wood species – softwoods (spruce, pine, fir, larch, douglas fir, etc.) and hardwoods (oak, beech, ash, maple, robinia, chestnut etc.) – can be used as poles and round timber.

4.2 Solid timber

– General

Solid timber (also sawn timber) is gained by sawing logs into prismatic members of different sizes. After sawing the members are usually technically dried to moisture contents of at least $u \leq 20\%$ (if possible to moisture contents equal to the equilibrium moisture content on site). Depending on the utilisation, sometimes it is also planned.

A disadvantage of solid timber is that it tends to crack and distort during the drying process. For softwood this behaviour can be explained by the different behaviour of the material in the inner core ("juvenile wood" within the first 15 - 20 annual rings with minor density and greater annual rings respectively, a stronger spiral grain and higher knottiness) and outer zones of



the log. If cracks in solid wood are to be avoided, the inner zones of the log should be separated during sawing. This leads also to members with higher dimension stability.

– Mechanical properties

The mechanical properties in compression and tension of softwood species, and with regard to bending strength too, increase with increasing distance from board's centre to the pith, mainly because of the lower knottiness but also because of the higher density in the outer zones of the log. As a consequence, sawn timber with high strength and stiffness should be obtained from there while members with a high required shear capacity should be cut from the inner parts of the log (this is an important fact for the assembly of glulam!).

Solid timber is usually visually strength graded in accordance to national standards (e.g. ÖNORM DIN 4074-1 in Austria). For boards and scaffold planks – in particular for the utilization of glulam – also machine graded sawn timber is used.

– Dimensions

Depending on the dimensions of the members, sawn timber can be termed as follows:

	Thickness, t / height, h	Width, b
Laths	$t \leq 40 \text{ mm}$	$b < 80 \text{ mm}$
Boards	$t \leq 40 \text{ mm}$	$b \geq 80 \text{ mm}$
Planks	$t > 40 \text{ mm}$	$b > 3t$
Square (sawn) timber	$b \leq h \leq 3b$	$b > 80 \text{ mm}$

Tab. 3.2 Dimensions of typical members of solid timber and their notation (in accordance to the definitions in ÖNORM DIN 4074-1)

Square sawn timber (in Middle Europe) is produced up to 16 m lengths, in increments of 0.5 m. Cross sections of square sawn timber are sold typically graduated in two centimetre increments up to a dimension of 200/240 mm. A standard-length for planks, boards and laths (in Middle Europe) is 4.0 m; available length span from 1.5 to 6.0 m. Typical dimensions may differ from the given values in the rest of Europe.

– Application

In the design of timber constructions, square sawn timber is applied for all types of members with load carrying purposes like columns, girders, stringers and other supporting elements. The utilization varies from general use in all areas of timber engineering, for formwork and general use in the building industry for all needs.

Planks are used for the creation of load carrying surfaces like scaffold boards, balconies or ceilings. Upright exposed planks are utilized for the production of trusses with punched metal plate fasteners.



Boards are used as roof or ceiling boarding, as supporting layers for balconies and terraces and for other purposes.

Laths are generally used as substructure in floors, for the roof construction and for façades.

In timber engineering, laths and boards can also be applied for ribbed shells and spatial curved lattice systems.

– Wood species

In Europe, predominantly local grown softwood species such as: spruce, fir, pine and larch, as well as douglas fir are used. Increasingly also hardwood species are utilized: particularly oak, beech, as well as ash and black locust (robinia).

4.3 Structural timber with special properties

4.3.1 KVH[®] (Construction Timber with/and without finger-joints)

– General

Apart from the specifications given for square sawn timber, structural timber with special properties called KVH[®] is produced increasingly. Due to lack of quality, in particular with the moisture content and the appearance of generally produced square sawn timber, the sawmill industry and the organisation of carpenters in Germany came to an agreement, at the end of the last century, about square sawn timber with standardised dimensions (so called “Preference Dimensions“), with defined moisture content of $u = 15 \pm 3 \%$, defined appearance qualities (visible and non-visible quality), and more restrictive regulations concerning deformation limits. KVH[®] is as a standard planed.

In addition to the aforementioned parameters, the square sawn timber is finger-jointed (in accordance with EN 386). To improve the further development and the reliability of structural timber, a product called GLT[™] has been developed where each member is tensile proof-loaded as output control is currently available on the market.

– Mechanical properties

The mechanical properties are comparable to solid timber. Usually KVH[®] is graded into the German grading class S10 in accordance to DIN 4074 (C24 in accord. to EN 338). More seldom, it is graded in the grading class S13 (C30).



– Dimensions

Standardised dimensions for KVH[®] and GLT[™] respectively are given in Table 3.3.

KVH and GLT	Width [mm]					
Thickness [mm]	120	140	160	180	200	240
60	✓	✓	✓	✓	✓	✓
80	✓	✓	✓	✗	✓	✓
100	✓	✗	✗	✗	✓	✗
120	✓	✗	✗	✗	✓	✓
✓ available as standard cross-section ✗ not available as standard cross-section						

Tab. 3.3 "Preference dimensions" for KVH[®] and GLT[™]

Depending on the cross section for unjointed timber, a length of 5 m and for finger-jointed members, a length of 14 m is available as a standard. For special orders, lengths up to 18 m are possible.

– Application

Structural timber is used similar to solid timber; for columns, girders, stringers and other supporting elements. In particular it is utilised for visible elements inside the rooms and as part of the roof construction.

– Wood species

Usually structural timber is made out of spruce. Pine, fir and larch can also be used as wood species for the production of KVH[®] and GLT[™].

4.3.2 DUO-/TRIO Beams

– General

DUO- and TRIO-Beams are build-up with two and three square-sawn timbers – in particular KVH[®] – that are glued on their broader sides in such a way that the outermost core sides face outside (similar to the production of glulam). This gives the advantage that the drying process can be achieved on relative small cross-sections, whilst KVH[®] can be applied for larger cross-sections.

Due to the relative wide glued area, which leads to greater inner stresses because of moisture differences, DUO- and TRIO- beams are only approved for the use in service class 1 and 2.

– Mechanical properties

The mechanical properties are similar to that of KVH[®] and solid timber. Because of the fact that in DUO- and TRIO-beams two or three members are stressed simultaneously, a system effect (on the relevant axis) can be taken into account.

– Dimensions

The permissible dimensions are given by limitation of the single cross-sections. Table 3.4 and 3.5 shows the standard cross-sections. Members with length up to 18 m are available.

Duo-Beam		Height, h [mm] (perpendicular to the glued joint)							
		100	120	140	160	180	200	220	240
Thickness, b [mm] (perpendicular to the glued joint)	80	x	x	x	✓	✓	✓	✓	✓
	100	✓	x	x	✓	✓	✓	✓	✓
	120	x	✓	✓	✓	✓	✓	✓	✓
	140	x	x	✓	x	x	✓	x	x
	160	✓	✓	✓	✓	x	x	x	x
✓ available as standard cross-section x not available as standard cross-section									

Tab. 3.4 "Preference dimensions" of the cross-section of DUO-Beams

Trio-Beam		Height, h [mm] (perpendicular to the glued joint)							
		100	120	140	160	180	200	220	240
Thickness, b [mm] (perpendicular to the glued joint)	180	x	x	x	x	✓	✓	✓	x
	200	x	x	x	✓	x	✓	x	x
	240	x	✓	✓	✓	✓	x	x	x
✓ available as standard cross-section x not available as standard cross-section									

Tab. 3.5 "Preference dimensions" of the cross-section of TRIO-Beams



– Application

DUO- and TRIO-beams enlarge the application possibilities of KVH[®] and solid timber respectively (because of the greater cross sections). In general it can be used for the same field of application as KVH[®] and solid timber.

– Wood species

Duo- and Trio-Beams are usually produced with spruce.

5 References

- [1] Madsen, B.;
“Structural behaviour of timber“,
Amer Society of Civil Engineers, 1995
- [2] Glos, P.;
“Strength grading“,
Chapter A6 from “STEP 1 – Timber Engineering“; First Edition, Centrum Hout,
The Netherlands, 1995
- [3] Schickhofer, G.; et.al.
“Holzbau – Der Roh- und Werkstoff Holz, Part A“,
Lecture notes, Institute for Timber Engineering and Wood Technology, Graz
University of Technology, Graz/Austria, 2004 (in German)
- [4] Augustin, M.;
“Eine zusammenfassende Darstellung der Festigkeitssortierung von Schnittholz“,
Diploma thesis, Institute for Steel, Timber and Shell Structures, Graz University of
Technology, Graz/Austria, 2004 (in German)

Chapter No. 3 has been prepared by Manfred AUGUSTIN, Institute for Timber Engineering and Wood Technology, Graz University of Technology / Austria.



WOOD ADHESIVES

1 Introduction

The utilisation of wood and timber without any additional actions is – due to its naturally given restrictions – limited to relatively short lengths and small cross-sections. One of the possibilities to eliminate these limits is to connect two or more wooden parts by means of adhesives.

An adhesive is a non-metallic – in most cases organic – material which joins solids by means of surface adhesion and cohesion in a way that the structure of the parts (assembly components) is not affected. This connection is produced without any mechanical fasteners and parts are bonded friction-locked. When loads are applied, the assembled parts act as one load-carrying member.

In these joints, the adhesives have the task to fill the gaps between the wooden members to be connected and to produce an adhesive bond for each member that is equally as strong and durable as the cohesive forces of the members themselves. Additionally the adhesive layer has to have sufficient durability to ensure the quality of the joint during the assigned service class over the expected life of the structure.

At the beginning of the gluing process, the adhesive has to be in a liquid form. When it is applied on the surfaces of the members it is necessary that it coats the surfaces in such a way that the attraction forces between the adhesive and the wooden parts are dissolved and the adhesive layer can penetrate the surface of the wooden parts. For the attainment of this, and to fill the gaps between the assembly components, an appropriate pressure on the wooden parts has to be applied. After a certain time, the liquid adhesive changes its characteristics into a solid layer – with sufficient strength and durability to bond the parts without pressure. This process – also denoted as curing or hardening – can be attained by a physical or chemical process, but also by a combination of both. For adhesives used to produce load-carrying glued-joints mostly a chemical process is involved since physical curing adhesives tend to show high creep ratios, which is not desired for load-carrying purposes.

A mechanical “toothing” between the adhesive layer and the assembled components is established through the penetration of the liquid adhesive into the wood cells of the surface and the following hardening process (Fig. 4.1).

The load-carrying capacity of the glued-joints are defined by the adhesion and cohesion of the gluing-line and the wooden parts and depends on many factors. The most important are: material of assembly components (quality and permeability of the (planed) surfaces, grain orientation, type and characteristics of the adhesive, working place conditions (temperature,

relative humidity), adhesive mixing and application, open / closed assembly time, pressure to be applied, press temperature, press time, workpiece geometry (linear or curved).

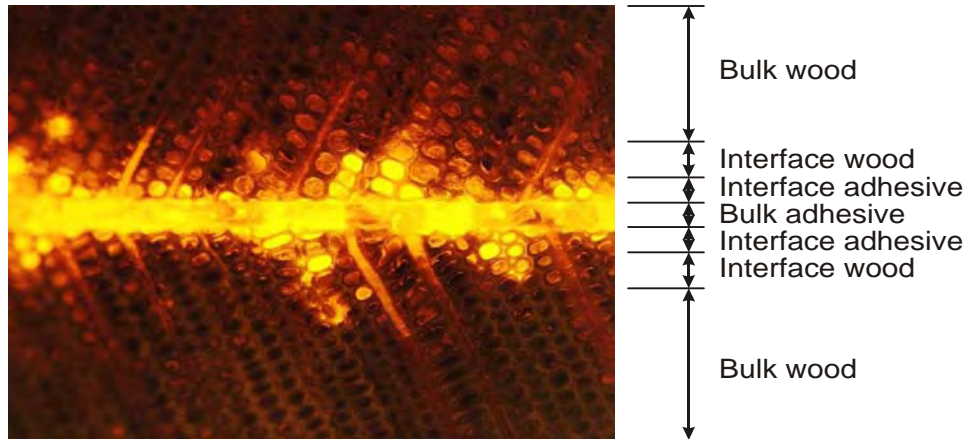

Fig. 4.1 Detail of a PUR-wood bond using fluorescence microscopy (Image by Dr. K. Richter, EMPA Dübendorf / CH, [5])

Further, it is a requirement of reliability and uncertainties of the production process that the glue-line must have higher strength than the surrounding wood.

Due to the wide range of requirements for the different purposes, adhesives in timber engineering have to be classified in general into those applicable for load-carrying purposes and those for non load-carrying purposes (e.g. for the gluing of windows, furniture production, wooden floors, etc.).

In addition it has to be mentioned that, apart from the aforementioned parameters, the choice of the appropriate adhesive has to be coordinated with the intended use of the product. This means that factors like temperature, duration of load, humidity, etc., have to be considered. Within Eurocode 5 this is done by the application of service classes.

2 Classification of adhesives in accordance to Eurocode 5

Within the framework of Eurocode 5 specifications for adhesives used for structural purposes are given in EN 301 “Adhesives, phenolic and aminoplastic, for load-bearing timber structures: Classification and performance requirements”. The corresponding test standards are given by the EN 302 series “Adhesives for load-bearing timber structures test methods”, (Part 1-7). These standards deal with phenolic and aminoplastic adhesives only.

In the aforementioned standards, adhesives are classified into:

- Type I – adhesives
(used for full outdoor exposure and temperatures above 50° C)
- Type II – adhesives
(used in heated and ventilated buildings and exteriors protected from weather. Only short exposure to weather or temperatures above 50°C are allowed.



In accordance with EN 1995, only adhesives complying with EN 301 are currently approved for load-carrying purposes.

Adhesives for gluing of engineered wood products used for load-carrying purposes (e.g. veneers, OSB, particleboards, etc.) are subject to special regulations, which have to be surveyed for the specific product and its use.

3 Type of adhesives used in timber engineering

3.1 General aspects

For the assembling of glued-joints, a huge range of different adhesives are available on the market. Adhesives can be – for example – classified by their curing mechanism into physical, chemical and combined hardening types. For load-carrying purposes, physical curing adhesives are generally used. A characteristic for this group is that certain chemical constituent parts are mixed in an appropriate ratio. Then the hardening process is activated by a chemical reaction of those elements. Depending on the type of chemical reaction (polycondensation, polyaddition or polymerisation), the type of adhesives used in the wood industry can be sub-grouped. Further, one must distinguish between one- and two-component adhesives depending on the number of involved components for the preparation of the adhesive.

The following gives a short description of the most important subgroups, with their most important properties and representatives, as key words.

3.2 Adhesives based on polycondensation

General properties for this type of adhesives are:

- Relative long press and curing time
- Brittle behaviour
- Develops shrinkage stresses
- Sufficient gap filling properties
- Fibre damage possible (due to acid hardener)
- Economic (UF)
- Long experience
- Emits formaldehyde



Representatives of this sub-grouped type are:

- Resorcinolformaldehyde (RF): Type I
- Phenolresorcinolformaldehyde (PRF): Type I
- Melaminformaldehyde (MF): Type I
- Melaminureaformaldehyde (MUF): Type I
- Ureaformaldehyde (UF): Type II

3.3 Adhesives based on polyaddition

Representatives of this sub-grouped type are:

- Emulsion-Polymer-Isocyanate (EPI): Type I
- One component-polyurethane (1C-PUR): Type I

Properties:

- Shorter curing times
- Less clamping pressure
- Higher bondline elasticity
- No fibre damage
- Low gap filling ability
- More expensive, but higher efficiency (less spread)
- Accepts higher moisture content
- No formaldehyde emission
- Low GT: tendency of temperature creep

- Epoxy adhesives

Properties:

- 2 component system
- Chemically highly reactive
- Low clamping pressure
- Brittle bondlines
- No fibre damage
- Good gap filling ability
- Bonds to most materials
- Expensive: mostly used for repairing and restrengthening
- Low TG: tendency of temperature creep

4 Types of glued-joints used for structural purposes

Depending on the geometrical position of the glued joints and its purpose, the following type of glued-joints for structural purposes can be distinguished.

4.1 Parallel (sideways) joints

For these types of joints, the glue has to transfer shear stresses parallel and tensile stresses perpendicular to the grain of both involved wooden parts. Adhesives that are approved for load-carrying purposes usually match these requirements without any problems. Because the grain direction of the bonded members are in the same direction, stresses due to changes of the moisture content (swelling and shrinkage) are small.

In practice, examples for these types of joints are the width surfaces in the production of glulam (see chapter 5) and the gluing of the narrow sides of single layers within the production of Cross Laminated Timber (see chapter 6). Furthermore, this type of joint also occurs in glued-in rods and in the gluing-line of ripped plates.

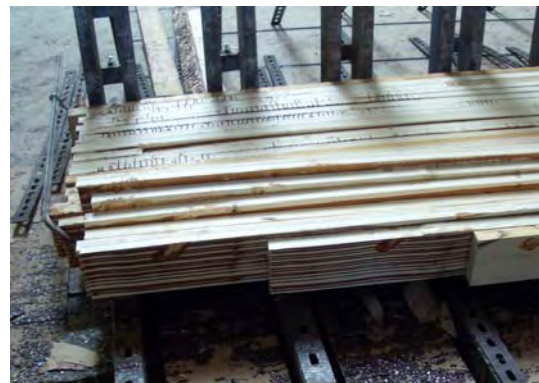
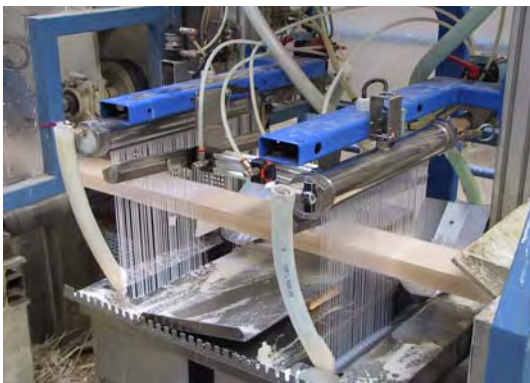

Fig. 4.2 Application of adhesive and pressing of glulam

4.2 End-to-end joints

The strength of these types of adhesive joints has to be higher than the tensile strength of the surrounding timber. The low load-carrying capacity of adhesives does not allow the production of butt-joints – at least for the outermost lamellas of layered products - for structural purposes. This problem is solved by a transfer of tensile stresses into shear stresses, which can be done by joining parts with inclined contact areas. This is usually applied to the production of scarf-joints and finger-joints in the timber industry. Ideally, the shear strength within the joint should match the tensile strength of the joined members. Since the ratio between these stresses is about 1:10, the glueline area of the joints should be 10 times higher than the cross section of the wooden part.

Since the alignment of both members is in the same direction, no problems due to swelling and shrinking will occur.



Fig. 4.3 Scarf-joint at the outermost layer of LVL and finger-joint at the section of a glulam lamella

4.3 Crosswise joints

In crosswise joints, the adhesive layer is loaded with shear stresses parallel to grain and tensile stresses perpendicular to grain. The required strength properties of the adhesive for these stresses is usually provided but in case of changes in moisture content, the jointed components swell and shrink under a more or less orthogonal angle, which initiates high stresses in the glued-area. This fact has to be considered when crosswise-joints are applied, e.g. in the production of CLT-elements or battenboards.



Fig. 4.4 Cross-wise joints for CLT, batten- and laminboards



5 The production of glued joints

The process for the production of glued joints can be split into the following steps:

- Drying of the wooden members to the equilibrium moisture content to be expected in the structure. This moisture content has to be in accordance with guidelines for the use of the adhesive.
- Visual or machine grading of the timber
- The surfaces where the adhesive will be applied have to be planed with appropriate tools. This has to be done preferably on the eve of the gluing process to avoid the presence of undesired dust, etc., on the surface. It is important to produce a well defined cut by means of sharp tools so that the adhesive can penetrate into the wooden surface (no damage of the planing surface).
- Mixing and application of the adhesive with appropriate equipment. Depending on the applied adhesive, certain requirements concerning the climate in the production rooms has to be fulfilled (temperature, humidity).
- Applying of sufficient pressure (depending on the purpose and product; e.g. for glulam: 3 – 5 N/mm²) to bring the surface of the members in contact with each other until the adhesive layer has achieved sufficient strength for further manipulation. It has to be mentioned that, depending on the specifications of the applied adhesive, a defined duration from the application of the adhesive and the initiation of the pressing process has to be considered.
- Transport to an intermediate storage for post-curing purposes; in some cases the application of heat or other techniques (e.g. ultra-high frequency methods) to accelerate the hardening process may be required.
- Conditioning of the bonded members to obtain post-hardening, even temperature and moisture equilibrium in the product (for some products e.g. glulam: repair works to get an appropriate surface quality). Finally cutting of the members to their intended geometrical dimensions.
- Packaging and logistic considerations.

6 Design and mechanics of adhesive-bonded joints

For the design of adhesive-bonded joints, a number of factors and parameters that affect the strength of the produced joint have to be taken into account. These parameters are, e.g.: moisture content of the timbers, magnitude and direction of applied forces, operating environment and design life.

Concerning the mechanical behaviour, adhesive-bonded joints with rigid and elastic characteristics can be distinguished.

Overlaps with rigid (thin-layered) glue-lines loaded by shear stresses will induce a peak at the ends of the joint where rips in the layer occur first. Areas within the glue-line transfer only small ratios of the load. A consequence of this stress distribution is that bigger glue-line areas lead to a small increase of the load-carrying capacity.

In contradiction to that in elastic (thick-layered) glue-lines shear-stresses with a more or less even distribution can be obtained. As a consequence, the glued-areas are exploited in a more efficient way which enables a higher load carrying capacity with an increasing glue-area.

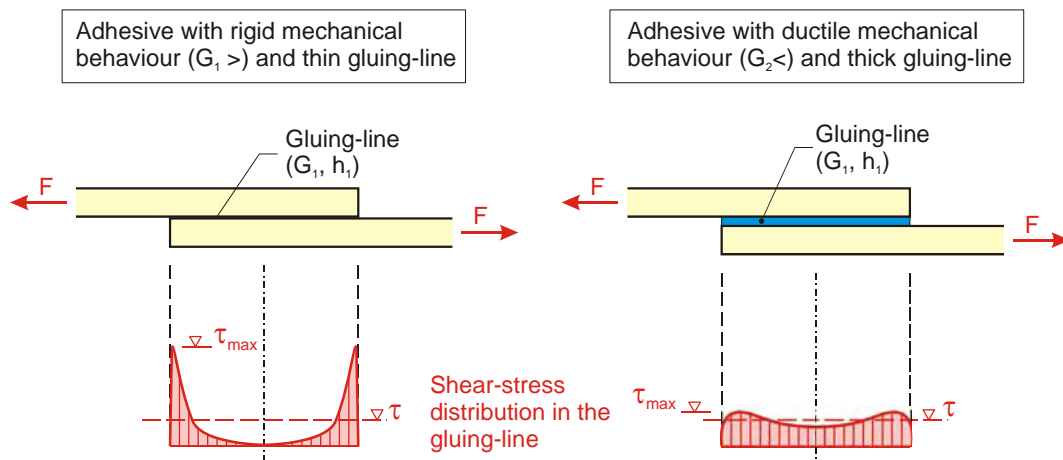

Fig. 4.5 Shear-stress distribution in the glue-line of an overlap produced with rigid / thin and ductile / thick adhesives

Adhesive layers applied in timber engineering are mostly thin-layered (thin-layered < 0.1 mm $<$ thick-layered). As a result, a quasi-rigid joint can be achieved.



7 References

- [1] Raknes, E.;
“Adhesives”,
Chapter A12 from “STEP 1 – Timber Engineering“; First Edition, Centrum Hout,
The Netherlands, 1995
- [2] Schickhofer, G.; et.al.
“Holzbau – Der Roh- und Werkstoff Holz, Part A”,
Lecture notes, Institute for Timber Engineering and Wood Technology, Graz
University of Technology, Graz, Austria, 2004 (in German)
- [3] Dunky, M.; Niemz, P.;
“Holzwerkstoffe und Leime – Technology und Einflussfaktoren“,
Springer, Berlin-Heidelberg, Germany, 2002 (in German)
- [4] Chaudhary, M.; Pocius, A.V.; (Ed.)
“Adhesion Science and Engineering,
Volume 1: The Mechanics of Adhesion”,
Elsevier Science B.V., Amsterdam, The Netherlands, 2002
- [5] Chaudhary, M.; Pocius, A.V.; (Ed.)
“Adhesion Science and Engineering,
Volume 2: Surfaces, Chemistry and Applications”,
Elsevier Science B.V., Amsterdam, The Netherlands, 2002
- [7] Packham, D.E.; (Ed.)
“Handbook Adhesion”,
Second Edition, John Wiley & Sons, West Sussex, UK, 2005
- [8] Davis, G.;
“The performance of adhesives systems for structural timbers”,
Paper, International Journal for Adhesion and Adhesives,
Vol. 17, Nr. 3, p. 247 – 255, 1997
- [9] Richter, K.;
“Gluing technologies and properties of GLT”,
Presentation, 1. GraHSE 2007, Institute for Timber Engineering and Wood
Technology, Graz University of Technology, Graz / Austria, 2007

Chapter No. 6 has been prepared by Manfred AUGUSTIN, Institute for Timber Engineering and Wood Technology, Graz University of Technology / Austria.



GLUED LAMINATED TIMBER

1 Introduction

1.1 Background

Structural glued-laminated timber or glulam is one of the oldest engineered wood products and is still very competitive in modern construction. Glulam is made up of wood boards which are glued together, so that they form a beam cross-section of the shape desired.

Glued constructions have been used for centuries, but the breakthrough of glulam occurred at the beginning of the 20th century by a German called Otto Hetzer. In 1906 he obtained the patent on his invention of curved, glued wood components, made up of several laminates, which are assembled under pressure and joined insoluble. Therewith, Hetzer had developed a unique technique, whereby the natural dimensions of wood could be overcome and durable constructions built.

Up to the beginning of the sixties, production was rather small, but since then it has increased continually, mainly due to the improvements in manufacturing techniques and adhesives, which have led and still lead to a better exploitation of this natural material.

1.2 Overview

Glued laminated timber is manufactured by gluing together and end jointing individual wood pieces – laminates – under controlled conditions. The laminates are arranged in horizontal layers with the grain in the longitudinal direction, which is contrary to cross-laminated solid timber, where the grain is alternately parallel and perpendicular. Cross-laminated solid timber will be discussed in the next chapter.

The production process of glulam in combination with modern gluing technology makes glulam a structural material of high-quality with unique characteristics. Compared to solid wood, glulam components achieve greater strength and stiffness properties and can be manufactured in almost any desired shape and size.

Due to its flexibility and adaptability glulam is suitable for a wide variety of uses, but especially for the construction of halls with large spans.

2 Glulam Production

2.1 Production process

The production process of glued-laminated timber is carried out in much the same way regardless of manufacturer or country. Figure 5.1 shows, schematically, a sketch of the manufacture.

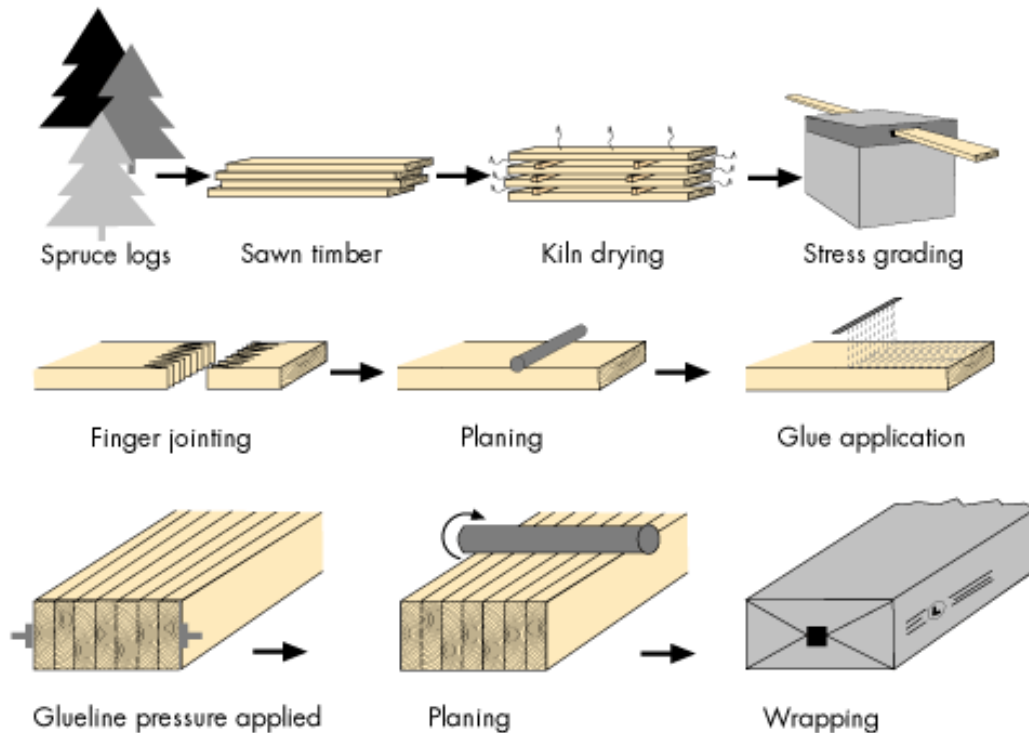

Fig. 5.1 Sketch of the manufacturing process
(Reproduced by permission of Svenskt Limträ AB)

In principle, any wood species can be used for glulam production, as long as a suitable adhesive is used. In practice, however, mainly softwoods are used, since the use of hardwoods is often associated with difficulties in gluing. Commonly used material is spruce.

- Planks or laminations of approximately 40-50 mm in thickness and 1.5-5.0 m in length are taken from an outdoor stockyard. For curved beams thinner laminations (20-30 mm) may be required.
- The laminations are dried to uniform moisture content, which must be 8-15%. The difference in moisture content between adjacent laminates may not exceed about 5%. The adhesive used requires a moisture content of maximum 15%. The strength of the glueline will then be optimal and the moisture content in the finished construction will be balanced, avoiding troublesome splitting.



- The dried laminations are sorted visually or, increasingly, by machine according to strength. The use of machines permits a more accurate sorting, which results in increased glulam strength values. The strength grading allows for the cross-section to be built up of laminates with approximately the same strength, so called "homogeneous glulam". To utilise the strength of the timber to best advantage, however, it is customary to place high quality laminations in the outer parts of the cross section where stresses normally are highest, and lower quality laminations in the inner zones, the so called "combined glulam" materials. In the factory it is therefore necessary to have a space to store at least two strength classes of laminate timber at the same time.
- The laminations are joined lengthwise by means of finger-joints to produce a continuous lamination. The joint profile is cut and the adhesive is applied. The laminations are then pressed together for at least two seconds. The continuous lamination is then cut into the lengths required and stored for a minimum of eight hours to ensure the curing of the glue.
- After the laminations have been cured, they are planed to remove the remaining rough surface and the unevenness at the finger-joints.
- The laminates are then immediately placed on top of each other, with their grain in the longitudinal direction of the member, and glued together to form the desired cross-section. For combined glulam, attention must be paid to the placing of the inner and outer laminates. To reduce internal stresses, the laminates are turned so that the core sides face the same way throughout the cross-section. The outermost laminates are, however, always turned with the core side outwards.
- The laminate packages are then lifted over to gluing benches and the necessary pressure applied. This operation must be carried out before the glue hardens, after an hour or so, the exact time depending on glue type and room temperature. The laminates may be bent when the pressure is applied, producing cambered or curved forms. The glue then hardens in controlled moisture and temperature conditions (typically at a relative humidity of 65% and a temperature of 20°C), possibly with the application of heat. Straight beams can alternatively be produced in a continuous high frequency press.
- When the glue joints have hardened, the pressure is released and the glulam components are planed on their sides in order to remove residual adhesive squeezed out of the joints and to ensure smooth surfaces. Then follows the finishing of the components, which includes various treatments and preparation work that benefit from being carried out under controlled conditions (e.g. fine sawing of arises, hole drilling for connections, application of coatings). Finally, the components are checked visually and marked before being wrapped and loaded for transport to the building site or to storage of finished goods.

Theoretically, glulam can be produced in almost any size. In practice, the size is limited for reasons related to transportation and factory outlet. Another limiting factor is the open time of the adhesive.



2.2 Quality control of the production

Quality control is an important part of the glulam production. It consists of an internal part performed by the manufacturer and an external part performed by an independent third body. Quality control includes bending or tensile tests of finger-joints and delaminating tests or shear tests to check glue line integrity.

The manufacturer has to establish a factory production control (FPC) system and a plan for tests of the products and do the testing. This will be verified by an independent third body, which, in addition, will make inspection visits at the factory and carry out the initial type testing. The execution of the quality control in accordance with relevant European standards, which for glulam are the following, permits the affixing of CE-marking on the products:

- EN 301: Synthetic resin adhesives (phenolic and amino plastic) for wood
- EN 385: Manufacture of finger joints of structural softwood
- EN 386: Manufacture of glued-laminated timber structural members

3 Properties

3.1 Material properties

3.1.1 Strength and stiffness

Glulam has in general the same strength characteristics as ordinary structural timber. The strength varies with the angle between load and grain direction, with moisture content and with duration of loading. Furthermore, there is a wide variation in material characteristics. Glulam, however, has greater strength and stiffness than corresponding dimensions of structural timber, because the variability in strength is smaller. Strength reducing defects of solid wood, such as growth defects, are either removed during the production process or more uniformly distributed in the finished product in such a way that each defect has less importance compared to solid wood.

As an example, the frequency distributions of the ultimate strength for glulam and structural timber are compared in Fig. 5.2. Structural components of glulam have a higher average strength and a smaller spread of strength characteristics than corresponding components of structural timber. This “lamination effect” is usually explained as follows:

Critical for the strength of structural timber is the strength of the weakest cross-section – usually at a knot or similar. The difference between boards is, therefore, considerable. In a glulam beam, however, laminations with different strengths are mixed and the risk that several laminates with major flaws should occur in the same beam is minimal. The load sharing between laminations in the glulam allows locally weak zones to redistribute stress to adjacent stronger regions.

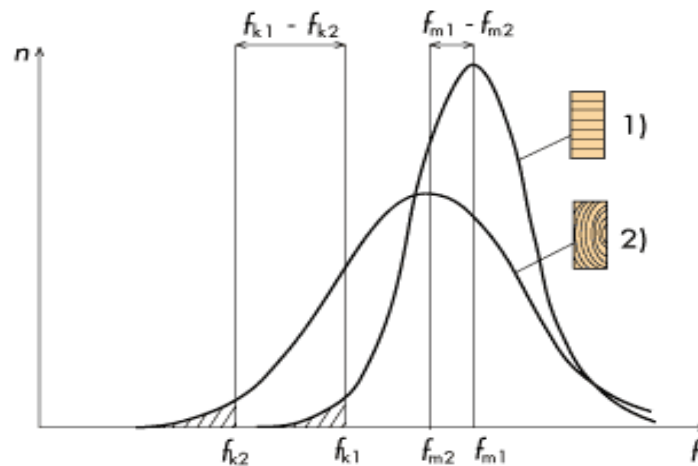

Fig. 5.2 Frequency distribution of the ultimate strength of glulam and structural timber (Reproduced by permission of Svenskt Limträ AB)

This fact is often recognized in safety or material factors used in design. In Eurocode 5, the material factor accounting for model uncertainties and dimensional variations is reduced to 1.25, while it is set to 1.3 for solid timber.

3.1.2 Size effect

In connexion with glulam and large cross-sections, the so-called "size effect" has to be mentioned. Glulam beams, which are tested to failure under laboratory conditions show very brittle failures, typically caused by a knot or a finger joint on the tension side of the beam. Since the probability that a beam contains a defect able to cause failure increases with an increase in the volume of the beam, the strength of large beams tends to be lower than that of small beams. Over the years, several investigations of this "size effect" have been carried out for determining the dependence of the strength of glulam on volume.

According to Eurocode (EC) 5, the effect of member size on strength may be taken into account for glulam. The characteristic values for bending strength and tensile strength may be increased for depths less than 600 mm by the following factor:

$$k_h = \left(\frac{600}{h} \right)^{0,1} \leq 1.1 \quad (h \text{ in mm}) \tag{5.1}$$

3.1.3 Strength to weight ratio

In comparison with its self-weight, glulam is stronger than steel. Wide spans are enabled due to its high strength to weight ratio. This means that glulam beams can span large distances with a minimal need of intermediate supports.



3.1.4 Drying defects

The laminations used in the glulam manufacture are dried individually to a wood moisture content of about 12 % before gluing. The limited lamination thickness allows a uniform drying, which minimizes drying defects. Moreover, the danger of damage taking place during the drying process in the construction is almost excluded since the equilibrium moisture content of wood used indoors is about 9 to 12 %.

3.1.5 Chemical resistance

Timber and the synthetic adhesives used in bonding glulam show a considerable chemical resistance and, therefore, glulam is ideal for use in buildings in chemically aggressive environments.

3.1.6 Pressure treatment

The protection of timber against fungi and micro-organisms is primarily done through detail design. As an option, timber can be pressure treated, whereby two different procedures are applicable with glulam: Laminates can be pressure treated either after gluing or before gluing. The first method requires the glue to bear the pressure of the treatment, but gives the best protection of the surface layer. This method, however, will only be used if the dimension and the shape of the glulam component fit into the pressure treatment equipment. The second method is possible provided that pressure treated materials can be glued, which depends on the combination between glue and used products.

3.1.7 Glue

For the manufacture of structural glulam, only approved adhesives with high strength and good durability are used. Requirements are given in EN 301, which classifies two types of glue, I and II. Glue type I may be used for glulam construction in any climate class, while glue type II is limited to climate classes 1-2.

Traditionally used are phenol-resorcinol-formaldehyde (PRF) adhesives which give dark red-brown joints. In recent years, however, it has become more and more common to use melamine-urea-formaldehyde (MUF) adhesives, mainly because they give light joints. Both PRF adhesives and MUF adhesives belong to glue type I, which is approved for use in any climate class, i.e. in- and outdoors. Today also polyurethane (PU) adhesives are approved for glulam. PU adhesives are classed as glue type II and give colourless joints.

3.1.8 Fire resistance

Like solid timber, glulam has good properties of fire resistance which are better the bigger the cross section is. The glued joints are more fire-resistant than the timber itself.

3.1.9 Cost effectiveness

Glulam is, with regard to cost effectiveness, competitive with other structural materials. The lower weight of glulam leads to lower transport and erection costs and affects favourably the cost of foundations. Furthermore, the flexible production of glulam enables curved structural components to be produced more cheaply than in other materials.



3.1.10 Environment and resources

Glulam manufacture uses little energy. The raw material is constantly renewed. It is taken from the natural life cycle and can be returned after its use without negatively affecting the environment.

If the aim is to optimise products from a well-managed source of raw material, glulam is one of the most resource-conserving ways of doing it. On the one hand, the higher strength and the smaller variability in strength of glulam compared to solid wood and on the other hand, the possibility to manufacture exacting structural demands means a more efficient utilisation of the raw wood material.

3.2 Versatility

3.2.1 Shapes and sizes

The manufacturing process of glulam allows a wide variety of shapes and sizes of structural components to be produced. This offers the architects and engineers many opportunities of designing their own forms, ranging from long straight beams to complex curved-arch configurations, while fulfilling the strength requirements. Thus glulam can more easily be adapted to market requirements by satisfying the most exacting structural demands. The limits are set by practical considerations such as the size of the production area, the possibilities of transport and the capacity of the mechanical equipment.

By combining the laminations in glulam, the production of large structural elements, which are much larger than the trees, is possible. Structural elements with lengths of 30 to 40 m are not unusual.

By curving the laminations during the production process a variety of curved-arch shapes can be obtained, which is not possible or very difficult with other materials. For this, thinner laminations are used depending on the degree of curvature.

3.2.2 Cross-sections

Different cross-sections can be manufactured depending on the strength and stiffness requirements. Commonly used cross-sections are rectangular sections, which can measure up to 2 m, but many other types of cross-sections, ranging from ordinary to custom-made sections can be manufactured as well. In Fig. 5.3 some examples of ordinary cross-sections are shown.

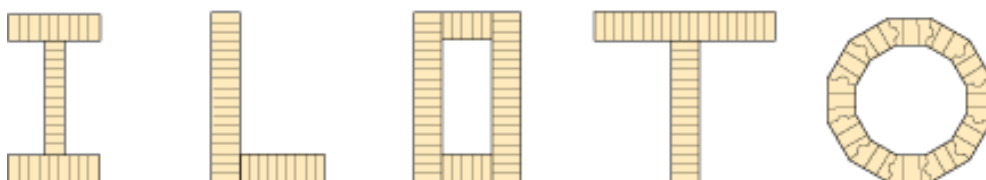

Fig. 5.3 Examples of glulam cross-sections
(Reproduced by permission of Svenskt Limträ AB)

In Fig. 5.4, the custom-made cross-section, which was required for the construction of the Leonardo da Vinci Bridge in Norway, is shown.



Fig. 5.4 Custom-made cross-section
(Reproduced by permission of the Norwegian
Public Roads Administration)



Fig. 5.5 Leonardo da Vinci Bridge in Ås, NO
(Reproduced by permission of the Norwegian
Public Roads Administration)

A further advantage of glulam is the possibility to vary the cross-section along the length of the structural element, in order to better adapt it to the distribution of forces. The central section of the beam can be made deeper in order to satisfy the increased structural requirements in this region of the beam.

3.2.3 Combined glulam

The use of laminations makes it possible to match the lamination qualities in relation to expected stress levels. Laminations of higher strength grade are often positioned in the outer highly stressed regions, while laminations of lower quality may be used in the inner zones. This allows a more efficient use of the available wood material.

According to Eurocode 5, the different lamination qualities have to be taken into account by using different material characteristics (characteristic strength and stiffness values) for homogeneous and combined glulam.

3.3 Design considerations

3.3.1 Aesthetics

The visual appearance of glulam is attractive and appeals to most people. Therefore, it can be presentable with no cladding, and even acts as a valuable addition to the interior and exterior environment.

3.3.2 Prefabrication

Glulam structures allow a quick and simple erection of prefabricated units. The parts are assembled irrespective of the weather conditions and a glulam frame can carry its full load immediately after erection. The drying of the laminations and the production process allow



the manufacture of glulam beams with accurate dimensions, which is required for the use of prefabricated units.

3.3.3 Transport and erection

Transport is normally by road. The type of the vehicle, which will be utilised, is mainly affected by the shape and the size of the components. Sometimes it can be advantageous if the beams can be divided up into shorter sections transportable on a normal lorry.

As a protection against rain/snow and dirt during transport, glulam components are delivered wrapped. On the building site, plastic wrappings should be cut open at the underside or removed completely to avoid moisture inside the film. The glulam components should then be protected from moisture, dirt and direct sunlight. Long-time storage on site should, however, be avoided.

The edges of glulam components should be protected as well, in order to reduce the risk of damage during transport and erection. When lifting by crane edges should be protected with metal angles or similar.

4 Structural use of glulam

4.1 Proper use of glulam

The principle of glued laminated timber has been around since the time of the early Egyptians, where the technique was used for the manufacture of wooden sarcophagi.

In the 19th century, people started to use glued laminated timber as a structural element in buildings. Probably the oldest construction, where glulam was used, is in the union hall of King Edward College in Southampton built in 1860. The roof truss of this hall is made of glued, curved tie beams.

Glulam did not, however, expand into a commercial construction method until the beginning of the 20th century when Otto Hetzer developed the “Hetzer-Binder“. At that time, glulam was used for the roof constructions with spans of up to 45 m. The lack of columns, which allowed the unhindered utilisation of the entire room, was regarded as a great advantage. In Switzerland for example, within a period of ten years, more than 200 structures were built using the Hetzer construction method.

The first structures where glulam as a construction material was preferred to steel were roofing structures for the covering of railway platforms. The reason was the strong corrodibility of steel, which was provoked by the exhaust of water vapour from the locomotives of the time.

Afterwards, the glulam construction method prevailed mainly in wide-spanned halls. In Otto Hetzer’s lifetime many buildings, such as sports halls, festival halls, warehouses, aircraft hangars, churches and other structures were built, which, to some extent, are still in use today.



The potential of the lamination technique was, however, not fully exploited. Applications were limited to dry-use conditions until, after World War II, waterproof synthetic resin adhesives were developed. This permitted the use of glued laminated timber in bridges and other exterior applications.

In the 1970s, curved beam techniques improved and modern high-volume plants were built to produce larger beams in a wide choice of section sizes. This revolutionised the availability and cost of glulam and gave it almost limitless potential, which enabled the use of glulam in a wide range of applications.

Nowadays, glulam has established itself as a building material in the construction of halls with spans of over 100 m. In Europe, for example, glulam competes alongside other structural materials in single-storey structures, factories, shopping malls, warehouses, airport terminals, etc. Glulam is particularly suited in situations where its aesthetically pleasing appearance gives it an advantage over other structural materials. Besides, almost any desired shapes can be designed with glulam, such as the roof of the elephant house in the zoo at Cologne, shown in Fig. 5.6.

In the USA, Central Europe and Scandinavia, glulam is growing in popularity in modern bridge construction, especially for pedestrian and bicycle bridges as well as road bridges with moderate spans. Curved glulam members can be used to produce various aesthetic effects and special types of bridges. An example of a road bridge is the "Europabrücke" in Murau, Austria built in 1993, which is made up of a glulam structure with a concrete deck, as shown in Fig. 5.7.

Another application of glulam, which has also become popular, is the use of laminated decks for floors in house construction. With such floor structures, combined with concrete or other materials, good sound absorption and fire resistance can be achieved at reasonable costs.



Fig. 5.6 Elephant house in Cologne
(Reproduced by permission of BAM Deutschland AG)



Fig. 5.7 Europabrücke in Murau, Austria
(Reproduced by permission of Josef Bärnthaler)



In the wide variety of applications of glued-laminated timber, glulam elements are mainly used as:

- Main beams, roof beams, purlins or columns in residential or industrial buildings
- Joist beams in floors with special requirements such as industrial floors or floors with large spans
- Lintels above openings in supporting walls
- Major and/or secondary structural elements in large non-residential buildings (e.g. arches, frames, girders, columns and truss members)
- Major and/or secondary structural elements in timber bridges

4.2 Typical structures

4.2.1 Beams

The most common form of a glulam structure consists of beams supported at each end by columns. For small spans usually straight beams with a constant depth are used. For larger spans it may be economically advantageous to vary the depth of the beam along its length in order to adjust the depth to the moments or shear forces. An example is the symmetrical double pitched beam, where the depth is at a maximum in the middle where the largest bending moment is. Beams of varying depth occur, e.g., as symmetrical or, exceptionally, asymmetrical double pitched beams, single pitched beams and roof beams in frame structures.

For aesthetic or functional reasons glulam beams are often manufactured with curved forms, whereby the sectional depth within the curved part can vary or be constant. A beam with a straight underside for instance, can be given a more or less pronounced curve. A popular form is the pitched cambered beam – a symmetrical double pitched beam with a curved underside.

In many constructions such as open-air stages, platform roofs and grandstands it is a requirement that one side of the building is open and free from columns. In such cases glulam offers solutions in the form of cantilevered, straight beams or curved brackets – half frames.



Fig. 5.8 Glulam beams in a library in Sweden (Reproduced by permission of Svenskt Limträ AB)

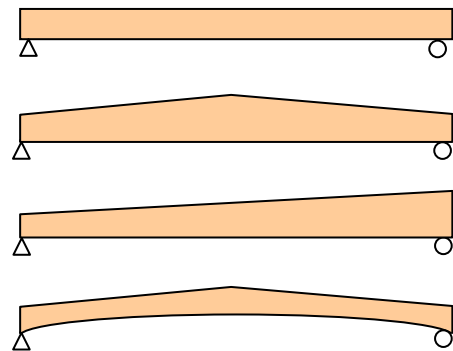

Fig. 5.9 Straight beam, double pitched beam, single pitched beam, pitched cambered beam

4.2.2 Columns and struts

Columns and struts are normally straight glulam components. They can be specially made or be standard beams from stock. A column can easily be manufactured with a capital at the top to reduce the stress perpendicular to the grain in the supported beam, or with a larger cross-section at the base to take up large moments of fixture.

4.2.3 Three-pin trusses

Over spans where the use of solid beams is too clumsy or consumptive, the use of trusses is more appropriate. Timber trusses are normally made up of stress graded timber members. However, for longer spans glulam is the dominating material. A common glulam structure, which can be regarded as a simple truss, is the three-pin truss. It is used for spans where ordinary timber trusses are insufficient.

Three-pin trusses consist of two glulam beams leaning against each other and with a hinged connection at the ridge. The beams are usually straight and of constant depth, but variations can also occur. The bottom ends of the two members are connected by a tension member – which is either in glulam or in steel – or hinged to the foundations. This type of structure is suitable for spans between 15 and 40 m. Larger spans (up to 50 m and more) with a three-pin truss can be designed with steel ties and timber struts as shown in Fig. 5.11.



Fig. 5.10 Three-pin frame in a barn in SWE
(Reproduced by permission of Svenskt Limträ AB)

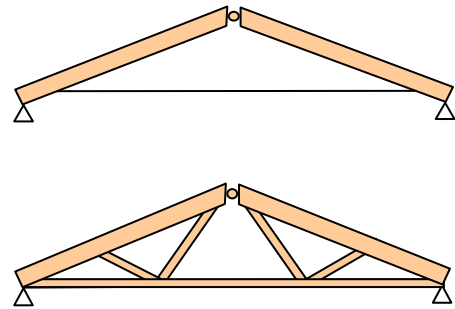

Fig. 5.11 Types of three-pin frames

4.2.4 Portal frames

Today almost all frame structures of timber are made in glulam. This type of structure is well-suited when increased headroom throughout the whole area of the building is required.

The traditional form is symmetrical on plan. The haunches can be executed differently as shown in Fig. 5.13 – curved, finger jointed, bolted or built-up. The form of the frame should follow the force line of the main load, as far as this is permitted by functional and aesthetic considerations. Curved or built-up haunches fulfil this requirement best and are, therefore, well suited for large spans of up to 30-40 m. If spans are larger, the two halves of the frame cannot be transported in one piece.

Interesting volumes can be designed through the combination with other constructive elements – curved or straight – or by three-dimensional arrangements of half-frames.



Fig. 5.12 Portal frame in a riding school
(Reproduced by permission of Svenskt Limträ AB)

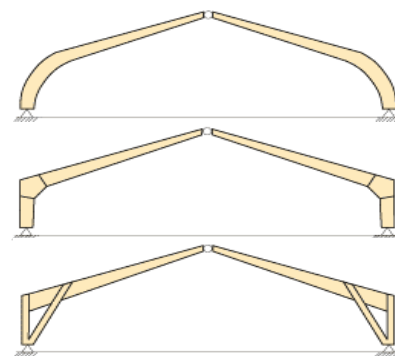

Fig. 5.13 Examples of frames with curved, jointed and built up haunches
(Reproduced by permission of Svenskt Limträ AB)



4.2.5 Arches

Arches are a type of construction very suitable for execution in glulam – a material which, without a great increase in price, can be produced in curved forms and with varying depths. Normally solid sections of constant depth are used, but composite sections can appear, especially for large spans. In order to keep the moments as small as possible, the form of the arch is chosen in such a way as it follows the thrust line. Thus, the material is better utilised in an arch and the constructional height will be only 1/3 of that in a beam of the same span and loading.

Arches are usually built with hinged fixtures at the supports and a hinged joint at the ridge. For spans of up to 60-70 m, three-pin arches are used, while for larger spans more joints can be desirable for transport reasons. The arch is then manufactured in several parts and joined rigidly on site. An interesting solution for large spans, in particular if the area to be covered extends in several directions, is a dome-like form, which is obtained by arranging arches radially. In this, vein spans of more than 160 m could be achieved.



Fig. 5.14 Arches in the Hamar Olympic Hall, Norway (Reproduced by permission of Svenskt Limträ AB)

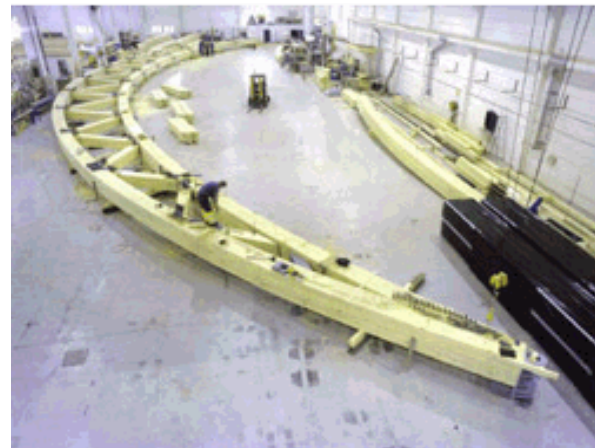

Fig. 5.15 Manufacture of an arch (Reproduced by permission of Svenskt Limträ AB)



5 References

- [1] Moelven Limtre AS,
“Limtreboka”,
2002
- [2] <http://www.brettschichtholz.de>
- [3] <http://www.glulam.co.uk>
- [4] Forrest Products Laboratory;
“Wood handbook – Wood as an engineering material”,
Gen. Tech. Rep. FPL-GTR-113, Madison, Wisconsin, 1999
- [5] Thelandersson, S. and Larsen, H.J.;
“Timber Engineering”,
John Wiley & Sons Ltd, England, 2003
- [6] STEP;
“Timber Engineering STEP 1 – basic of design, material properties, structural
components and joints”,
Centrum Hout, The Netherlands, 1995
- [7] Treteknisk og TreFokus AS;
“Trebaserte konstruksjonselementer”,
Fokus på tre Nr. 27, Oslo, Norge
- [8] Aune, P.;
“Trekonstruksjoner, Del 1, Materialer – Dimensjonering – Forbindelser”,
Tapir, 1992

Chapter No. 5 has been prepared by Kjell Arne MALO and Vanessa ANGST, Department of Structural Engineering, Norwegian University of Science and Technology / Norway.



WOOD BASED PANELS (IN PARTICULAR CROSS LAMINATED TIMBER (CLT))

1 Introduction

Wood and timber have been utilized since the dawn of time in its natural, bar-like, shape as round wooden logs or as a sawn product, typically with a rectangular cross-section. For many purposes wood products are needed as enclosing or sheathing material, for load-carrying elements in shear-walls or as heat-and noise insulating material. Naturally, this can be done with, e.g., boards or other sawn products, however, this is mostly uneconomical. There are, furthermore, other disadvantages with bar-like wooden members like the distinctive anisotropic behaviour when subjected to loads and moisture changes (shrinkage/swelling).

This chapter will give a short introduction into so-called “Wood Based Panels” or maybe more common in the references “Engineered Wood Products (EWP)” (this denotation will be used in the following), describe an order system for them and give insight into the main representatives that comprise them.

Further, this chapter is dedicated in particular to giving information about the product “Cross Laminated Timber (CLT)”, which will probably, in the near future, become the most important product for massive timber constructions for residential and multistorey buildings.

2 Engineered Wood Products

2.1 Overview





In the course of the production of “Engineered Wood Products (EWPs)”, the raw material wood is milled by different processes into pieces with certain dimensions and subsequently bonded by means of adhesives or – in special cases – with mechanical fasteners.

In contrast to natural products like round wood and structural timber “EWPs” are products that have “engineered” and “designed” properties.

With this procedure, the typical anisotropic effects of solid wood can be cancelled or at least decreased and, apart from bar-like products, also two-dimensional (load carrying) elements with relatively big and variable dimensions like plates (loaded perpendicular to the main dimensions of the element) and panels (loaded in the direction of the main dimension of the element) can be produced.

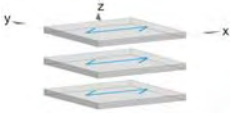
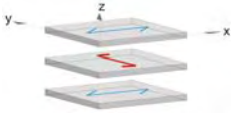
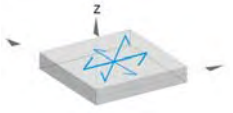
In addition these products offer the advantage of using wood with poor quality, or even recycled wood, for their production. Furthermore, the decreasing influence due to single defects like knots, grain deviation, variability of the density, etc., on the physical properties can be compensated, which enables the possibility of fabrication of products with homogenous properties.

Depending on the size of the used pieces (in a descending order of components size: boards – veneer – particles and strands – wood-fibres) and their mutual orientation (grain orientation of components parallel or orthogonal to the main direction of the element as well as “random“ orientation), a big variability of products with distinctive dimensions in one- or two-directions can be produced. With these two parameters, an easy to remember scheme for 2D- EWP-products is given in the following Tab. 6.1. A similar table can be drawn-up for 1D-products. However, they are not given here.

Basic wood component Grain orientation of the components	Orientation of components in one direction 	Orientation of components in orthogonal direction 	“Random” orientation of components 
Wood fibres (- particles) 	Extruded products	-	Fibreboards; Particle (chip-) boards
Strands 	Longitudinal Strand Lumber (LSL); Parallel Strand Lumber (Parallam)	Oriented Strand Lumber (OSB)	-
Veneers 	Longitudinal veneer lumber (LVL)	Plywood; LVL with orientation of some veneer in transverse direction	-
Boards 	Glulam (facewise); BRESTA	Cross Laminated Timber (CLT)	-

Tab. 6.1 Overview of wood engineered products with distinctive dimensions in two directions

In the following, a brief overview regarding the production process, properties and the utilisation of the most important two dimensional EWP's will be given:

2.2 Products based on wood-fibres

Wood-fibres are extracted from pre-chipped round timber and waste wood by means of so called "defibrators". These devices split-up the wood structures into fibre-bundles using steam and/or chemical treatment until a fibre-pulp is obtained. With this, a formable "fibre-cake" can be produced, which is then pressed through a number of different production processes – wet, semi-dry or dry – under addition of natural and/or synthetic adhesives and/or inorganic (e.g. gypsum, mineral components, etc.) and chemical additives to fibreboards.

Depending on different parameters of the production process, boards with a big variability of mechanical characteristics and utilisation possibilities can be produced. Due to the small dimension of the components, alignment of fibres is not possible (except for extruded products). As a consequence, products with random orientation can be manufactured. In general, the type of fibreboards can be distinguished with regard to their density into non-compressed: rigid and semi-rigid insulation boards and compressed: intermediate or medium-density fibreboards, hardboards and special densified hardboards.

For building purposes, fibreboards can be used in a large variability of types and sizes as load-carrying and non load-carrying sheathing material and for heat and sound insulation purposes.



Semi-rigid insulation board



Medium-density fibreboard

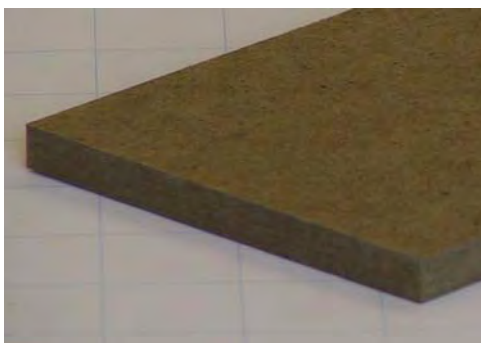

Hardboard



Utilisation of fibreboard in a roof construction

Fig. 6.1 Different types of fibreboards and their utilisation in a roof construction



– Particleboards

Particleboards (otherwise also denoted as "chipboard") are an EWP manufactured with wood particles such as wood chips, sawmill shavings or even saw dust and/or other lignocelluloses fibres (e.g. flax or other agricultural residues). For mineral bound particleboards, also cement and other inorganic materials can be used.

Although the basic components of particleboards are bigger than fibres or fibre-bundles, these products are usually mentioned under this category.

For the production of this product in general, particles, flakes and chips from softwood or medium-density wood species are preferred. Particleboards can be "extruded" or, more commonly, "flat-pressed".

In the course of production, these products are produced by milling, drying and mixing the particles with synthetic adhesives and additives (e.g. wax to reduce hygroscopic properties and sometimes fungicides, insecticides and fire-retardants). In a further step, the "particle cake" is scattered into a single layer or, more commonly, three-layers (more seldom into five-layers), with the same or different mix of components for each layer and continuously hot-pressed. The final production steps comprise conditioning, sanding and trimming of the particleboards.

The mechanical behaviour of particleboards depends strongly on the geometry (size and form) of the particles, their orientation, the number of layers, the type of adhesives used and the pressing procedure. In general, the particles are aligned in one direction. In cross-section, a strongly graduated density profile can be observed with peaks at the surface of the boards.

The typical range of thickness is 8 mm to 50 mm (up to 80 mm), with lengths up to 14 m and widths up to about 3 m. Depending on the existing service class of the utilisation, different products are available.

Particleboards are applied in a broad range within the building and furniture industry for load-carrying and non load-carrying purposes, e.g. as wall- and floor-sheathing material, for webs of I-joints, etc.



Fig. 6.2 Particleboard



2.3 Products based on strands

For the elimination of single defects in EWP, structural timber is fragmented into small components and subsequently bonded by means of adhesives into products of appropriate sizes – in most cases flat panels, but also into bar-like products.

The basic components are obtained by chipping or slicing and specified as “strands”, “chips”, “flakes”, “wafers”, etc. depending on the dimensions of the particles. These are reaching from a few centimetres up to decimetres in length, 10 to 30 mm in width and thicknesses of 0.4 mm up to 4 mm.

A common property of this product group is the orientation of the particles relative to the length of the future element, but also the size and variability of their dimension influences strongly their mechanical behaviour and, therefore, the utilization of the product.

Subsequently the most important products of this group will be described:

– Oriented Strand Boards (OSB)

Oriented strand boards (OSB) have been originally developed with the intention to replace the lower grades of plywood on the market. For their production, large particles – called “strands” – with typical dimensions: 60 mm to 150 mm length, 10 mm to 35 mm width and 0.4 mm to 1,0 mm thickness - are produced by means of “ring flakers” (rotating drum with knives inside) from low quality, small-diameter round wood of – in general – coniferous species.

After a drying process, strands are graded and mixed with adhesives and wax additives. Subsequently, the mix is laid into a three layered structure, typically with the surface layers oriented in the direction of the mat, and a core layer of about 50 % of the volume with “random” or transverse orientation. The resulting mat is then pressed by means of a continuous row of presses. At the end of the production process, the surface quality is achieved by sanding, coating with and without a paraffin layer, edge finishing and cutting into appropriate sizes, respectively.

Due to the aforementioned configuration of OSB, the mechanical parameters in the direction of production are considerably higher than in the transverse direction. This has to be taken into account during the verification process.

Similarly, for particleboards, a distinctive variation of density along the thickness profile is formed by the pressing process, which influences the board’s mechanical behaviour. As a consequence, panels with smaller thicknesses have higher mechanical characteristics compared to thicker ones.

By having the 3-layered cross-section, a high level of form stability is given in the direction of the panel. When exposed to the effects of moisture, an increased swelling in thickness is to be expected (as for particleboards). This is especially true for the edge of the boards. Because of the sensitivity of OSB to moisture conditions, the utilisation of OSB/3 and OSB/4 is limited to their use in service classes 1 and 2, in accordance with EN 1995-1-1. For load-carrying purposes, the thickness should be no smaller than 8 mm because of buckling problems.

OSB is often used as sheathing and stiffening material for load-carrying and non load-carrying purposes in residential, single and multistorey buildings.

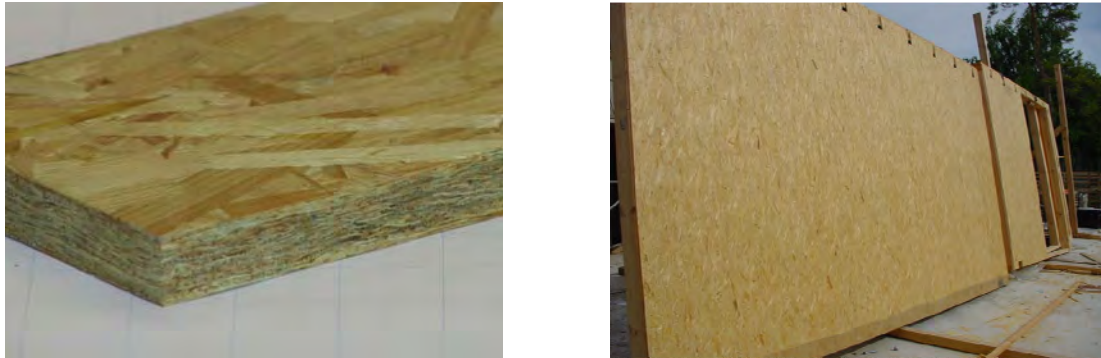

Fig. 6.3 OSB and its utilisation as load-carrying sheathing material in a shear -wall

— Laminated Strand Lumber (LSL)

Laminated strand lumber (LSL) is built-up with particles very similar to those used for the production of OSB. However, bigger “strands” with lengths up to 300 mm, 30 mm widths and about 1 mm thicknesses are used for these boards. These particles are primed in the usual manner, blended with polyurethane-based adhesives, aligned parallel to the direction of the mats and pressed with high pressure by means of steam injections to the required thickness. The used wood species is often Aspen, but also the production with a combination of different wood species is possible.

LSL is available as bar like products and as panels with dimensions of up to 14.63 m in length, 1220 mm in depth and thicknesses up to 140 mm. Due to the production process, these products have a strong homogenisation with high mechanical properties and resistance against swelling and shrinkage due to moisture is assured.

LVL is used for elements which need high mechanical performance, e.g. as a bar like product (beams, posts etc.), but is also used as panels. In combination with other EWPs, they can be used, e.g., for the web of I-joists. Due to their aesthetical interesting surfaces, they can also be used as a visible element with or without coatings.



Fig. 6.4 LSL and their use as beams



– Parallel Strand Lumber (Parallam)

Parallel strand lumber (Parallam) is a bar-like product similar to LSL and LVL (see below) with longitudinally oriented components. Unlike LVL, for the production of Parallam veneers are cut into stripes which are dried to 2% - 3% moisture content, mixed with waxed components, bonded with waterproof structural adhesives and redried under pressure by means of a microwave process. As a result, members with cross sections of up to 275 x 475 mm and lengths up to 20 m can be obtained. Since the process of striping/stranding reduces many of timbers' natural growing characteristics like knots, pith pockets and slope of grain, Parallam is a dimensionally stable product with more uniform properties (strength, stiffness, density) along its axis than structural timber.

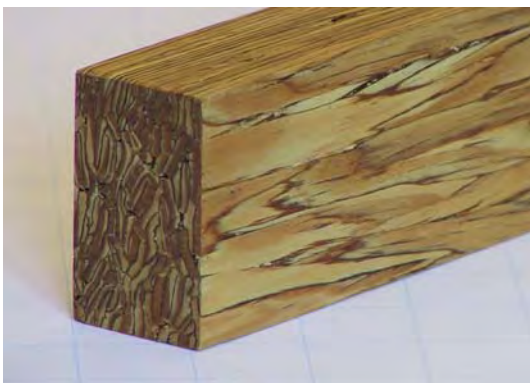

Fig. 6.5 Parallam and its use as chords in a truss

2.4 Products based on veneers

Products of this category are built-up with 2 mm to 4 mm thick veneers (or plies), which are manufactured by rotary peeling of (steamed) logs, slicing or (more seldom) by sawing. After kiln drying, unwinding, grading and cutting, the veneers are glued with an alignment parallel – with an even or uneven changing orientation of each layer – or orthogonal to their grain direction. Due to the distinctive orientation of the basic component, it makes no sense to align them in a “random” manner.

Depending on the form and size of the used components and the orientation of adjacent layers, different products can be manufactured:

– Plywood

For the production of plywood, generally an uneven number of veneers with equal thickness and the same wood species are glued into flat panels. The orientation of the veneers is orthogonal. This provides a product with the possibility of load-transfer in two directions, and restrained swelling and shrinkage movements of the elements. If necessary veneers of single layers are connected by means of scarf-joints.

Mechanical properties are affected by geometrical factors (number and thickness of veneers), material factors (wood species, moisture content) and load factors (type of stress, direction of stresses to grain of the face veneer, duration of load). In particular, it has to be considered whether the element is loaded as a plate (loaded perpendicular to element's

plane) or as a panel (loaded in-plane). For the verification process, which is in general based on linear stress-strain behaviour with a rigid connection of each layer, this fact leads to distinctive differences for the characteristic values in both directions. When plywood is loaded perpendicular to panel's plane in some layers, "rolling-shear" occurs.

Depending on the wood species used, plywood has a good durability which can additionally be controlled by the use of a chemical treatment.

Plywood is the oldest EWP and can be used as load-carrying and sheathing material in lightweight walls, floors and roof constructions in a broad range of uses. Plywood is sometimes also used for the web of I-joists and in combination with other EWPs.



Fig. 6.6 9-layered plywood (robinia) and the use of plywood as stiffening elements in a shear-wall

— Core plywood

Core plywood consists of a sandwich configuration seen in cross-section with one or two (cross laminated) surface plywood layers and an orthogonal oriented core, which is made out of different materials. Depending on the core material, different products can be specified:

Name of the product	Core material
Wood core plywood	Solid wood or veneers
Battenboard	Stripes of solid wood more than 30 mm wide; glued or unglued on their edge
Laminboard	Stripes of solid wood 7 mm to 30 mm wide
Cellular board	Stripes of solid wood or veneer not wider than 7 mm
Composite plywood	Materials other than wood (e.g. paper, insulating foams, etc.)

Tab. 6.2 Types of core plywood, depending on the material of the core



From the mechanical point of view, panels with a distinctive load-carrying direction and an adequate stiffness in the perpendicular direction can be manufactured. A big advantage of core plywood is that components with poor quality can be used for the core.

Within the verification process, the type of core has to be considered because of possible big shear-deformations. In addition, the occurrence of “rolling-shear” stresses has to be taken into account.

Core plywood can be used for a huge number of applications. In particular it can be used for (visible) load-carrying and not load-carrying purposes, as singular members, but also in combination with structural timber and other EWPs. For example, laminboards are often used as skin for formwork constructions because of its moisture regulation abilities.



Fig. 6.7 Battenboard and laminboard

— Laminated Veneer Lumber (LVL)

Unlike plywood, the layers of laminated veneer lumber (LVL) are aligned in the longitudinal direction of the element. As a consequence, it has similar (anisotropic) behaviour similar to structural timber, but is more homogeneous and has higher stiffness and strength. Veneers of good quality, which are generally joined with scarf-joints and butt-joints for the outer and inner layers, respectively, are used in the production of LVL.

Certain grades of LVL also include a few sheets of veneer (e.g. every 5th layer) orthogonal to its main direction to enhance the strength properties in this direction.

LVL is used as panels or plates, but also as bar-like products and is available in lengths of up to 23 m, 1.80 m in width and a thickness from 21 mm up to 75 mm. In combination with structural timber and/or other EWPs (e.g. for ribbed plates, etc.), LVL is a high performance and economical product.



Fig. 6.8 LVL and LVL with layers in transversal direction

2.5 Products based on boards

The basic component for these products are sawn boards typically from 6 mm up to 40 mm thick, ≥ 60 mm in width and 1.5 m up to 5 m (as a standard 4.0 m) length. For use as a load-carrying element, boards have to be graded according to an appropriate code or standard. Normally boards are dried to a moisture content of 12 % to 18 % and planed before being machined and assembled. Depending on their further use, boards can be end-jointed by means of finger-joints. In this case the board is also called lamellae.

- Products with distinctive dimensions in one directions (bar-like products)

If more than four laminates are bonded together by means of adhesives and built-up so that the grain of all laminates are aligned parallel to the longitudinal axis – perhaps the most important, bar-like wood engineered product for load-carrying purposes – glulam is assembled. More details and information concerning glulam is given in chapter 5 of this handbook.

- Products with distinctive dimensions in two directions

- Single layer panels

Single layer panels are produced by gluing boards on their edges. For building purposes, single layer panels are seldom used as a load-carrying element. In general these panels are used in the production of furniture with the application of different wood species.

- Edgewise aligned and mechanically jointed boards (BRESTA) and transversal pre-stressed wooden decks

The product BRESTA, which consists of edgewise aligned boards that are jointed with nails or screws, are in particular used for floor and roof constructions. Glulam elements, which are edgewise loaded, are also used for floor constructions. It must be stated that for both elements, consideration for spacing because of swelling and shrinkage due to changes in the wood moisture content, must be taken.

Wood decks, built-up with edgewise aligned boards and pre-stressed with tension loaded steel-rods, can be used for decks of timber bridges.

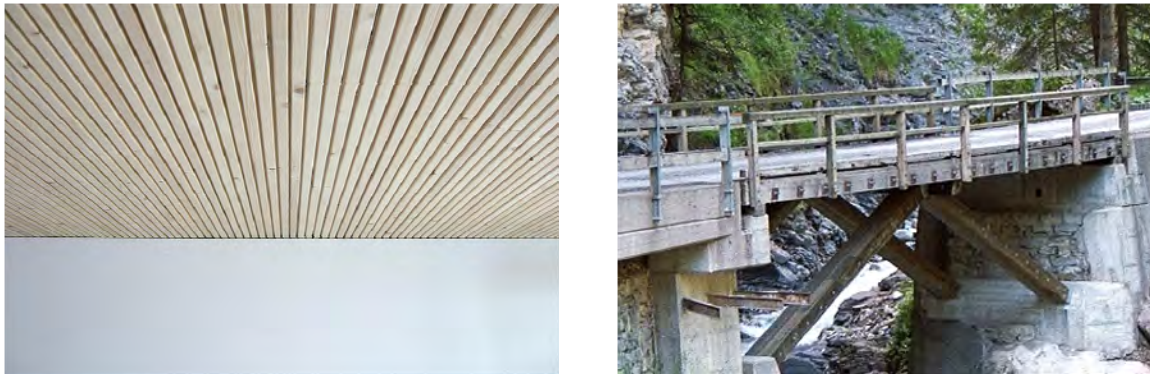

Fig. 6.9 Edgewise aligned and mechanically jointed boards (BREASTA); Transversal pre-stressed wood deck

— Cross Laminated Timber

Cross Laminated Timber (CLT) consists of layers built-up with boards. Their assembly in orthogonal directions allow them to produce elements with big dimensions. It is expected that this product will play an important role in the future use of wood in single and multistorey buildings. Because of this, CLT is described in detail in the next part of this chapter.

3 Detailed description: Cross Laminated Timber

3.1 “Massive Timber Constructions” vs. “Lightweight Timber Constructions”

This part of the chapter has the intention of presenting the basics of the so-called “Massive Timber Construction Method” (MTC). The content will point-out not only an alternative to “Lightweight Timber Constructions” (LWC), but also differences to similar construction systems made of masonry and concrete systems for residential, multistorey and industrial buildings. In particular, special features of the relatively new building system with “Cross Laminated Timber (CLT)” elements will be shown.

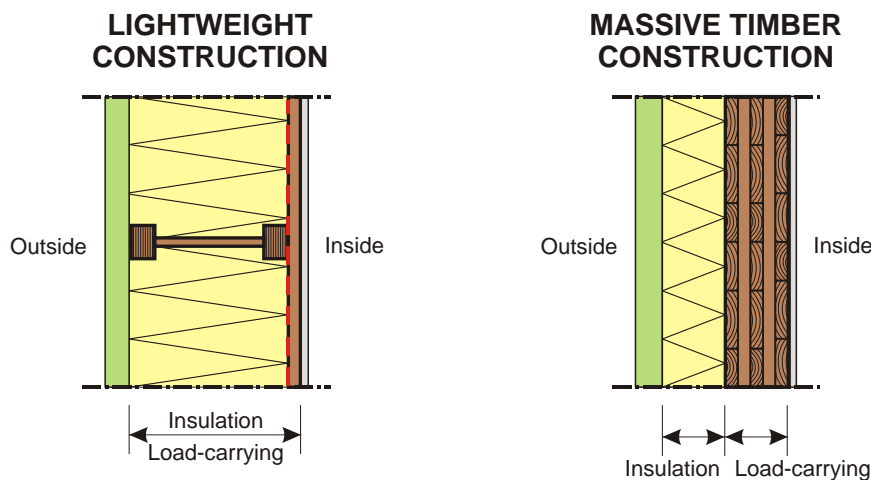

Fig. 6.10 Comparison of lightweight and Massive Timber Construction

The most important difference between the aforementioned construction systems is that in MTCs, a clear separation of the load-carrying and insulation function of the single layers is given. In addition, for MTCs and LWCs different product families are used. In comparison to lightweight constructions, where bar-like products with sheathings are used, for MTC-systems large sized laminar elements are used.

Furthermore, the MTC-system has the advantage that in general no vapour barrier is needed and, in comparison to LWC-systems, a higher heat storage capacity can be achieved. For both building systems, a flexible arrangement of facade elements is possible.

For MTCs, the use of massive, big sized load-carrying plate and panel elements (e.g. with CLT-elements) – under the precondition of an appropriate connection technique for the elements – is achievable, and in general a high stiffness of structures can be obtained. This is an important factor for the erection of buildings with high dynamical actions (e.g. in areas with high earthquakes actions).

Nail laminated timber-systems are a possible application of the MTC-system too. These are plate-like elements that are usually produced by stacking boards on their broader sides and connecting them with mechanical fasteners (nails, screws, hardwood-dowels). To attain a sufficient stiffness, these elements are covered with EWPs on one side and/or bar-like diagonals are necessary. Currently, these elements are generally used for floors in residential buildings.

3.2 From boards to elements – The production of CLT-elements

The basic material for the production of CLT-elements are (raw) sawmill-boards, which are best taken from the outer zones of the log. These side-boards – sawmillers usually cannot get a high price for them– generally have high mechanical properties relating to stiffness and strength.

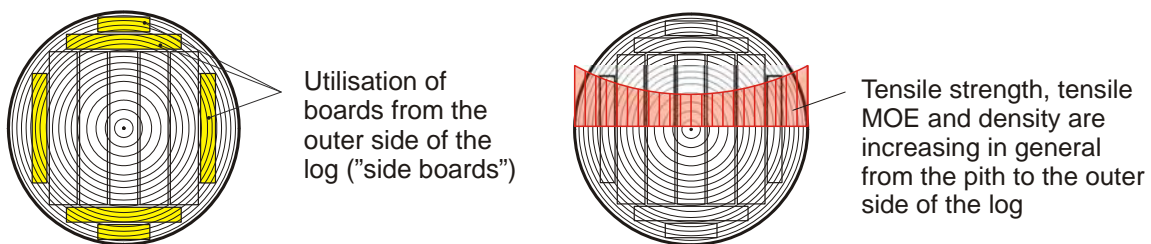

Fig. 6.11 Sawing pattern with boards from the outer zones of the log; distribution of mechanical properties of log's cross section

The width of boards for the production of CLT-elements are usually 80 to 240 mm, with a thickness from 10 to 45 mm (depending on the producer, up to 100 mm). The width to thickness ratio should be defined as $b : d = 4 : 1$. Currently, usually coniferous wood species (spruce, pine, fir) are processed, but also deciduous species (e.g. ash, beech) could be used in the future.

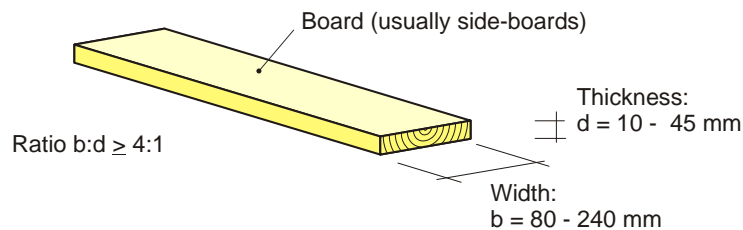

Fig. 6.12 Boards (from the outer zone of the log) as basic material for the production of CLT-elements

Depending on the field of application (use, affects), CLT-elements can be built up using different grading classes for the boards of the longitudinal and transversal layers. Characteristic properties of the single boards are the tensile strength, the (tensile) modulus of elasticity and the density.

For the outer layers, boards should consist of appropriate grading classes and their ends should be finger-jointed (it is recommended to finger-joint the boards of all layers).

For the gluing of finger-joints and lamellas, respectively, adhesives approved for load-carrying purposes (class and performance requirements in accordance to EN 301) have to be used. Usually adhesives based on polycondensate (PU), phenolic and melamine resins are applied. Depending on the service class, an appropriate moisture content of the boards is necessary.

In a next production step lamellas (=boards + finger-joints) are planed on all four sides. Edge sides can be planed to a parallel, profiled (groove-and-tongue) or conical form.

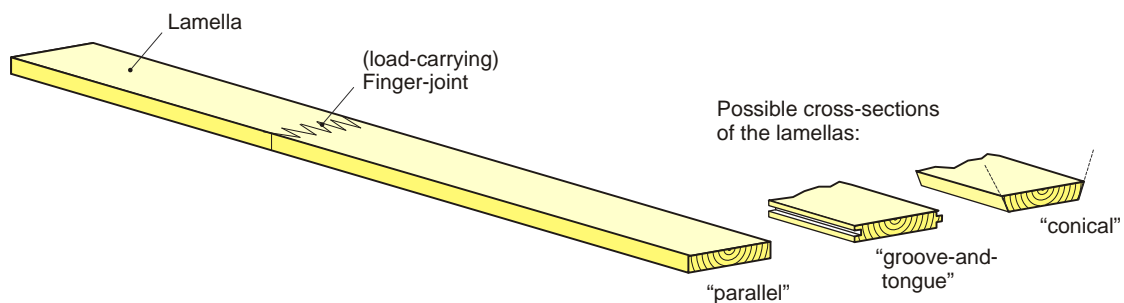

Fig. 6.13 Lamellas with parallel, profiled or conical edge side

Finger-joints have to be produced in accordance to EN 385. As a goal, a similar quality to that of glulam-lamellas should be achieved. This means – in accordance with EN 1194:1999-09 – for the finger-joints a characteristic tensile strength of 5 N/mm² higher than that of the boards strength class (ft,0,l,k) has to be reached.

Test results show that CLT-elements can achieve bending strength that, at least, is comparable with those of glulam GL24h. Because a few lamellas are loaded similarly when bending actions are applied, a so-called "system effect" can be applied for the design process. Details for the design of CLT-elements in bending are given in [10] and [11].

The production sequence is to assemble the lamellas to a single layer-element. To achieve better mechanical and building physical properties, but also because of aesthetical reasons, lamellas should be glued on edge. The finger joints of separate lamellas should be displaced with appropriate distances. According to EN 386:1995 (which is valid for the production of glulam), a distance of one third of the lamellas' width should be observed as a displacement distance. However, it is suggested that one uses the whole width of a board as a displacement distance.

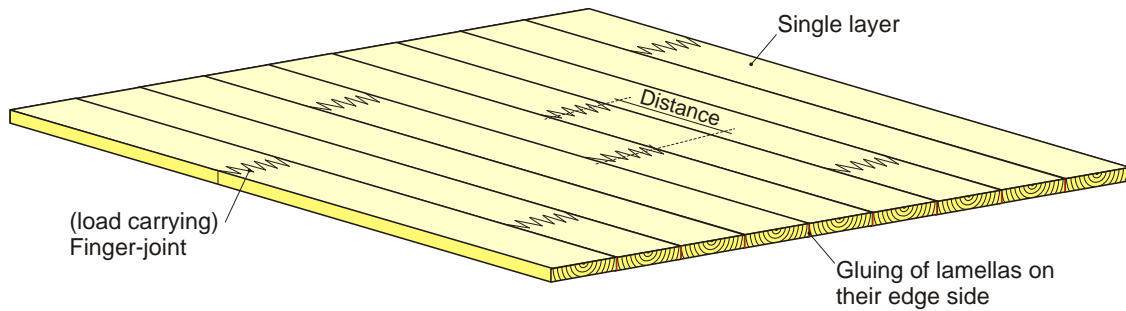

Fig. 6.14 Single layer produced with lamellas glued on edge

The typical assembly of the single layers of CLT-elements is orthogonal. But layers can also be arranged with orientations under other angles (e.g. 45°). The quasi-rigid connection of the single layers is attained by gluing of the whole single layer area. As a consequence, an appropriate system for the distribution of the adhesive is necessary. In addition, the guidelines regarding forming pressure of the adhesives used must be strictly adhered.

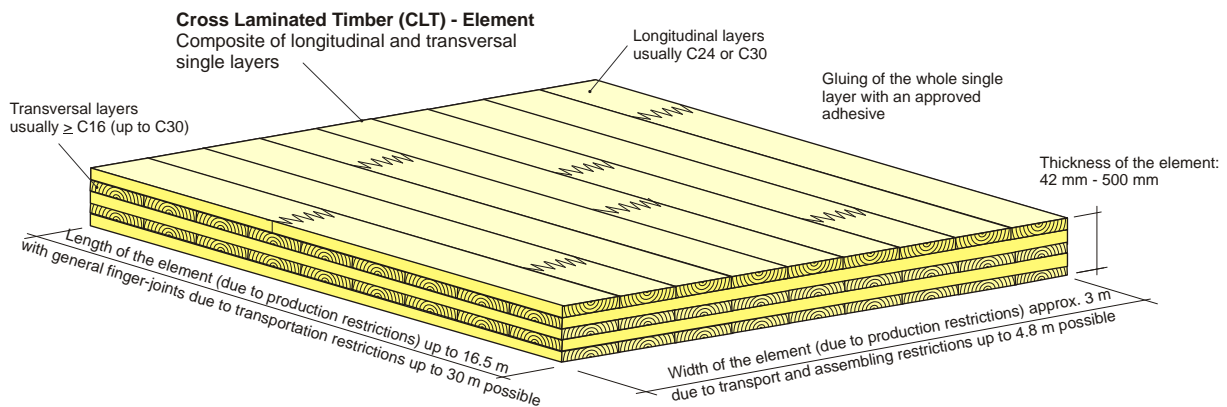

Fig. 6.15 Configuration of a CLT-element (5-layered)

Size and Form of CLT-Elements are given by restrictions concerning production, transport and assembly. Currently, planar and single-curved elements with dimensions of 16.5 m in length, 3.0 m in width and a thickness of up to 0.5 m can be acquired as a standard. Greater lengths (of up to 30 m) can be assembled by means of general finger-joints. For curved CLT-elements, the thickness of the lamellas has to be adjusted to the curvature. Regulations are given in e.g. EN 386:1995 (valid for glulam).



Fig. 6.16 Planar and curved CLT-elements in the production process

For the production of CLT-elements, different configurations of longitudinal and transversal layers allow an optimisation concerning mechanical and fire-protection requirements.

With three (five) layered elements, a thickness of about 100 mm (170 mm) can be produced. For bridge decks, considerably thicker elements are available.

Currently, no standards or codes for the production of CLT-elements exist, but various companies have approvals for their products. For the verification procedures, European and national standards are known. In general, the use of CLT-elements is restricted to service class 1 and 2.

CLT-elements are available as an industrially produced greenware with an invisible quality of the outermost layers. If a visible quality of these layers is necessary, appropriate products with and without contribution to the load-carrying capacity can be applied.

The outermost load-carrying layers in visible quality should be used on both surfaces of the element due to symmetry reasons of the cross-section. Materials for these layers can be groove-and-tongue single layers, batten- and laminboards, and LVL and OSB.

For the outermost layers with non load-carrying properties, the required properties regarding visible quality, resistance against fire and noise insulation can be used. These layers can be applied on one or both sides and can be connected by means of screws, nails or glue. Apart from the already mentioned materials, fiber and gypsum boards can be applied for these purposes.

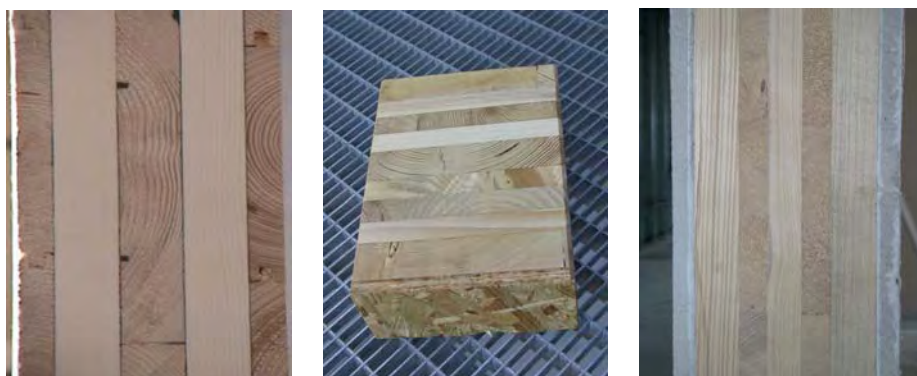

Fig. 6.17 Different outermost layers for CLT-elements (groove-and-tongue layer, OSB and gypsum boards)

3.3 Modelling and load-carrying behaviour of CLT-elements

3.3.1 General aspects

During the verification process of structures it has to be checked that the requirements (static equilibrium, ultimate design limit state, serviceability limit states, robustness) for the structure, but also for single members (e.g. CLT-elements), are fulfilled. As part of this procedure, verification must be made that all loads can be carried by the structure and its members, but also at local points (e.g. at the load introduction). In any case, the load carrying capacity of the joints must also be investigated.

The load carrying capacity and the serviceability behaviour of CLT-elements is influenced in general by the size, form and number of openings (doors, windows, chimney openings, staircase openings, openings for domelights etc.), by the make-up of the cross section (number and thickness of layers, grading class and wood species of the materials used, orientation of the layers) and the quality of the production.

The determination of internal forces and stress distributions for CLT-elements is dependent on the appropriate modelling of the structure and the elements. Subjected to the purpose of the analysis (pre-design up to detailing design) for the modelling, the geometry, number and forms of openings, the cross-sectional configuration, properties of the material and jointing of the elements, but also the boundary conditions of the supports, have to be considered.

3.3.2 Cross layers in CLT-elements – Rolling shear

Compared with those loaded in the longitudinal direction to the grain, strength- and stiffness properties of (coniferous) timber perpendicular to the grain are very low. As a consequence, particular layers of the cross-section which have to carry loads perpendicular to the grain, because they are stressed in tension and compression and the so-called "rolling-shear" (shear in the radial-tangential-plane), lead to relatively low load-carrying capacities.

Release-grooves, which are milled into the boards, and unglued narrow faces on the boards within the single layer influence the already limited shear strength further.

The complex load carrying behaviour of the cross oriented layers is in practical verifications of engineers in general reduced to a simple shear verification problem of a beam. The used design models are based on homogeneous single layers which are represented by their thickness, stiffness- and strength properties.

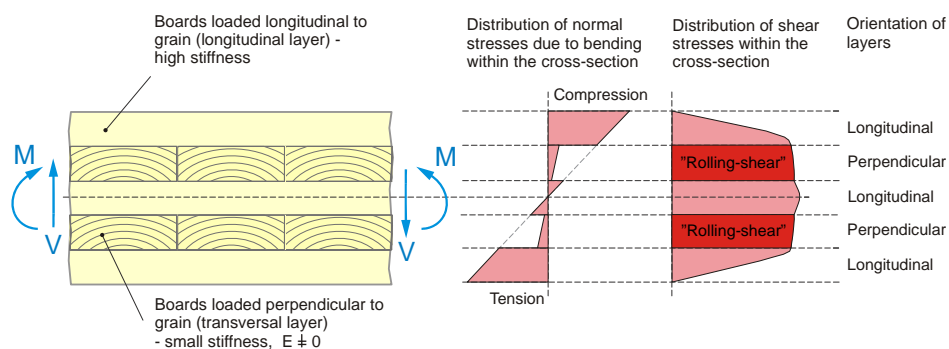

Fig. 6.18 Stress distributions of a CLT-element with glued narrow faces of the boards loaded by a moment and a transversal force

Shear stresses that leads to strains in planes perpendicular to grain are called „rolling shear stresses“ (e.g. in accordance to DIN 1052:2004-08).

From bending tests with CLT-elements with an intended shear failure it is known that the failure and the failure mechanism is initiated within the cross layers. From the analysis of the failure mechanism it can be seen that a combination of two failure forms – rotation of cross layers and “rolling” of earlywood zones, is responsible for the failure. In the following figures 6.19 and 6.20, these facts are illustrated.

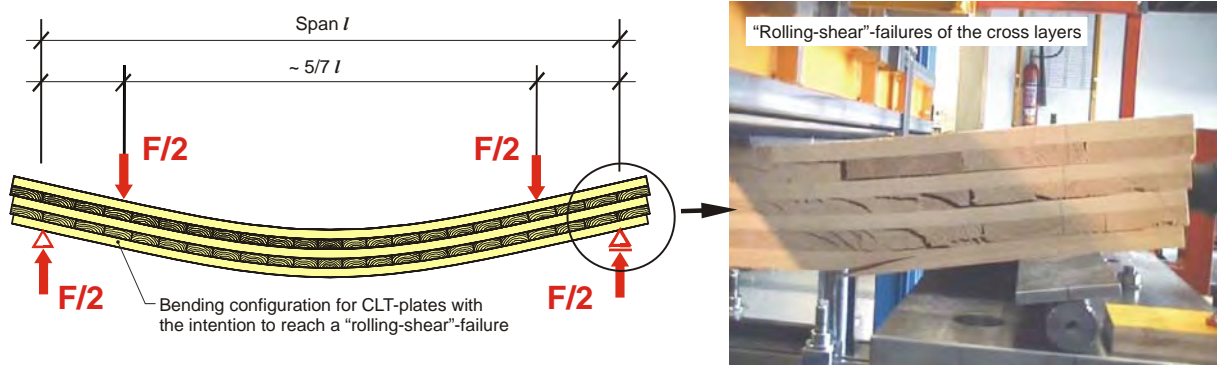

Fig. 6.19 Failure in the cross layers of a CLT-element during a bending test (elements without glued narrow faces of the board)

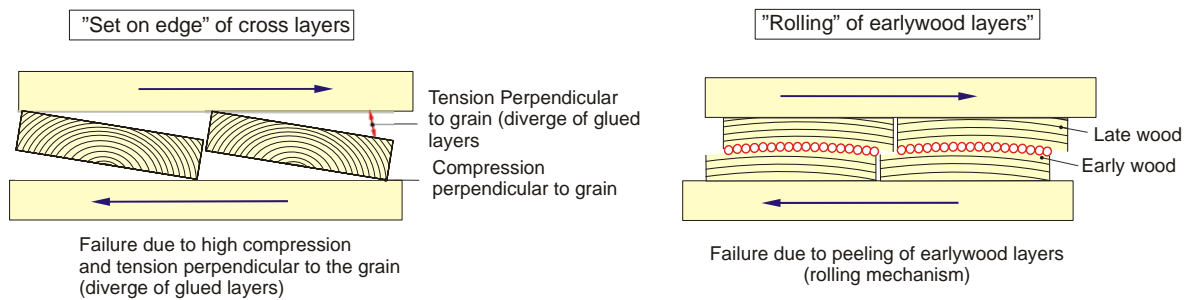

Fig. 6.20 Failure mechanism within the cross layers of a CLT-element (macroscopic)

A numerical analysis shows that the “rolling shear modulus“ (shear stiffness at loadings in a plane perpendicular to grain) is not a material parameter but can be handled as a “smeared“ shear stiffness characteristic dependent on structural wood parameters (e.g. form elasticity-, geometry- and size parameters but also from production specifics).

In the following table, the main influencing parameters on the “rolling shear“ properties are listed. In addition, the used wood species and strength class of the boards are considerable parameters.

Influencing parameters on the "rolling shear" properties	positive → negative
Board dimensions of the cross layer	
Position of the boards in the log (sawing pattern)	
Annual ring width and density (Ratio earlywood : latewood)	
Production Pressure Type of adhesive	
Type of loading	

Tab. 6.3 Increasing and decreasing parameters on the "rolling-shear" properties

It has to be mentioned that, in the references and different codes and standards, values for the "rolling-shear" properties are proposed with a big variability. When verifying a member, the appropriate value for the product has to be evaluated.

3.4 Verification and standards

Currently, no regulations for the production and use of CLT-elements are given in the framework of the European standards or in most of the national standards except, e.g.

DIN 1052:2004. Instead, rules for the application, verification and production are given in different European and nationally valid technical approvals of the producers.

Mechanical parameters of CLT-elements can be determined on the basis of the properties (MOE, strength, density, etc.) of the single layers and boards, respectively. A load-carrying model similar to the "beam model" for glulam has been published, e.g. recently in [10].

For a roughly verification of layer's stresses in plates a rigid connection between the layers can be assumed. This model gives sufficient precision for the evaluation of the stresses. For verifications in the serviceability limit state, the flexibility of the cross-layers has to be considered. For a rough determination of the elastic deformations, an additional amount of 20 % regarding the design of "rigid" cross-sections should be taken into account. For more detailed verifications, sophisticated models that consider the shear flexibility of the cross-layers can be used (for more details see e.g. [12]).

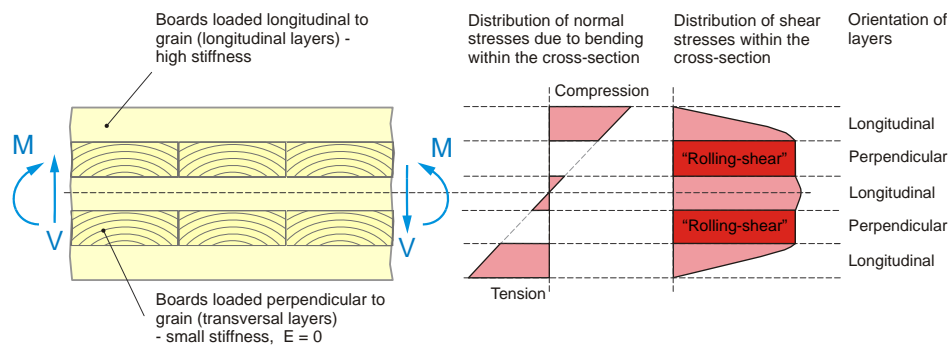

Fig. 6.21 Stress distributions of a CLT-element without glued narrow faces of the boards loaded by a moment and a transversal force

For elements built-up with a "rigid" connection of each layer (consisting of boards, veneers and strands), e.g. for CLT, a verification procedure based on the classical theory of the strength of materials is given in DIN 1052:2004, as already mentioned. This method proposes a consideration of shear-deformations.

A summary of the regulations is given below:

- Structures with distinctive dimensions in two directions can be verified, as panels when the elements are loaded in the plane, and as plates or as a grillage of girders when loads are applied perpendicular to their plane.

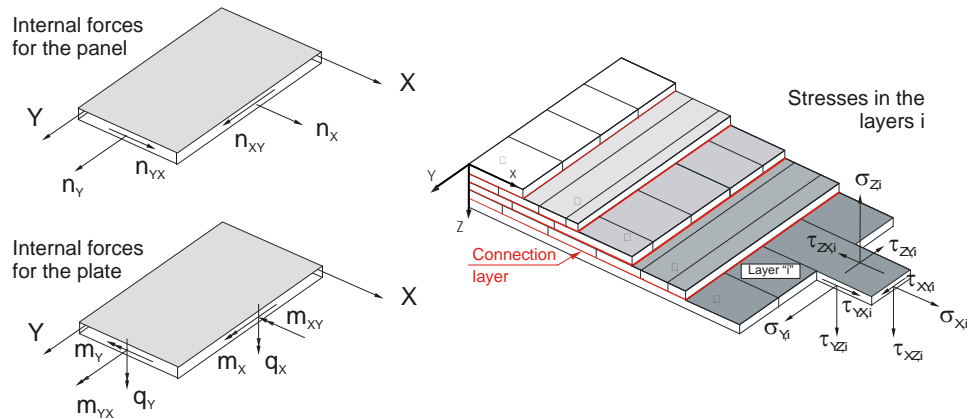

Fig. 6.22 Denotation of internal forces for panels and plates and of stresses in the layer i

- Deformation and stress values have to be computed as a composite with rigid layer-interfaces. Loads perpendicular to grain (compression and tensile stresses perpendicular to grain) and “rolling-shear” stresses have to be considered.
- For the calculation of cross-section values in the direction of the main axis, the configuration of the element has to be considered. The modulus of elasticity perpendicular to grain for elements with unglued narrow faces of the boards can be neglected.
- The influence of shear deformations has to be considered.

3.5 Modelling of plates

Depending on the configuration of the cross-section, the ratio of dimensions in length and width ($l : b$) and the type of supports, loads can be transferred by one- or two-axis bending. Depending on the supporting boundary conditions, CLT-plates are usually modelled as single- or multi-span beams in one-axis bending. If a two-axis bending is assumed for the modelling, the type of joints at the boundaries of the plate (mostly simple overlaps of the elements modelled as hinged joints) and openings have to be considered.

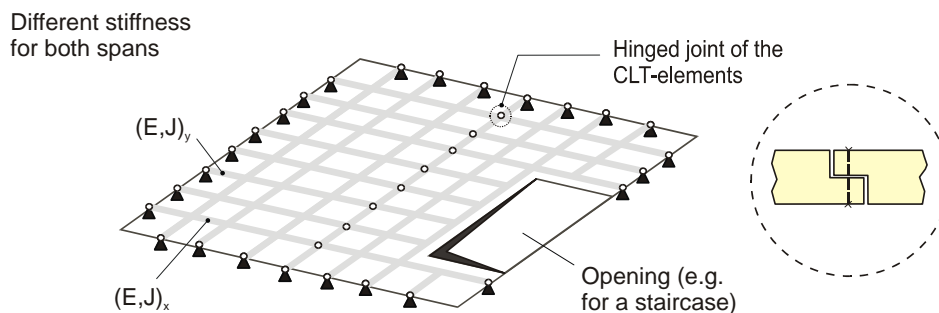

Fig. 6.23 Modelling of a plate with two-axis load transfer by means of a grillage of girders (with consideration of the boundary-edge of the element and openings)

Massive CLT-floors are usually considered as being stiff panels (when loads apply in the plane), which are designed for the transfer of horizontal loads (from wind actions, earthquake actions, etc.). With the consideration of construction rules in common, no verification for these loadings are necessary.

For the deflection of plates in the serviceability limit state in addition to those caused by bending the influence of shear-deformations have to be considered necessarily due to the low values for the “rolling shear” modulus (approximately with a value of the shear modulus of $G_{90, \text{mean}} \sim 50 \text{ N/mm}^2$).

To avoid undesired dynamical effects, deformations due to permanent forces (without the influence of creep-effects) have to be limited to 5 mm. If this cannot be guaranteed, detailed investigations (e.g. with FEM) have to be done.

3.6 Modelling of shear-walls

For the modelling of shear-walls built up with CLT-elements, truss- and frame-models may be applied. For more detailed investigations also Finite Element Models can be used.

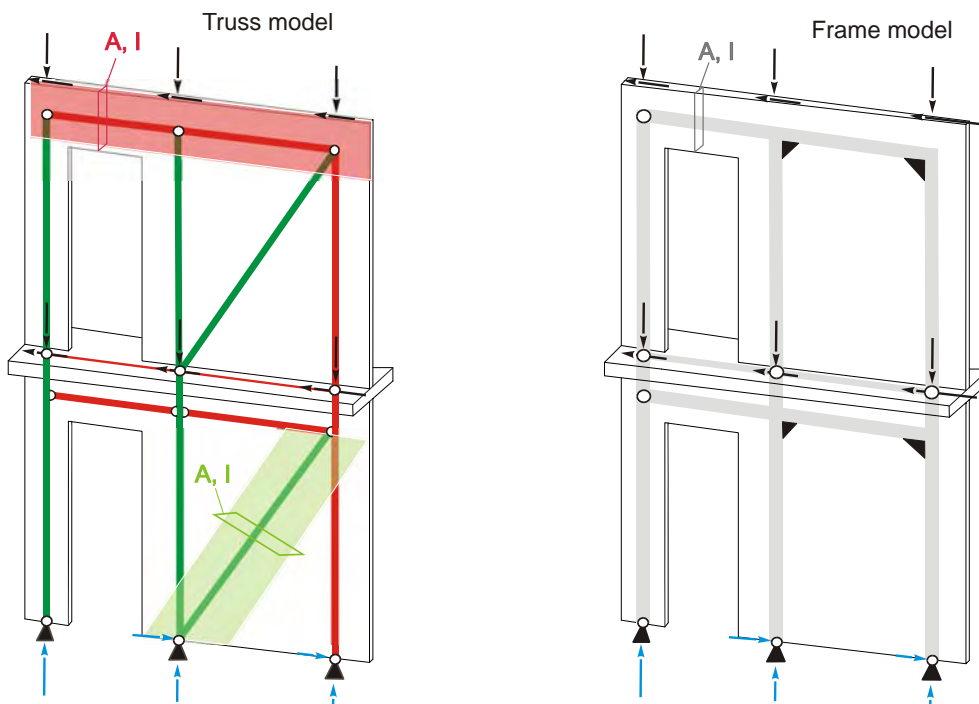

Fig. 6.24 Modelling of a two floors high shear-wall loaded by vertical and horizontal actions by a truss and frame model respectively

For the verification of door- and window-lintel beams, appropriate models have to be developed. A simple modelling for hinged- (for small wall columns) and rigid-supported walls sections is shown in Fig. 6.25.

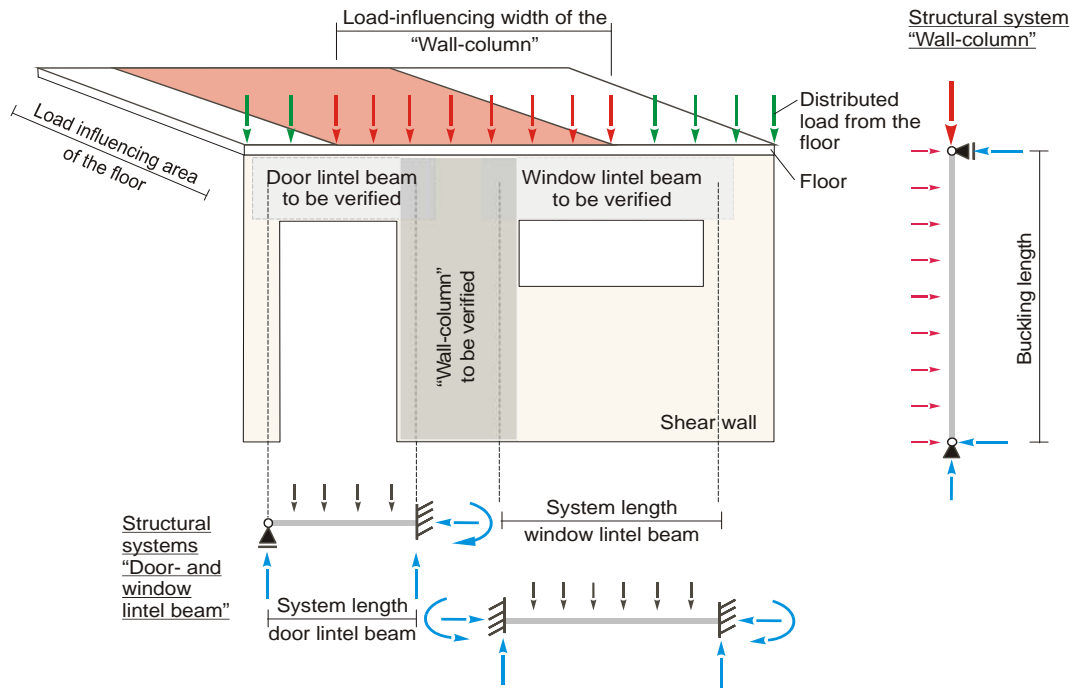

Fig. 6.25 Modelling of the floor-wall-edge, the “wall-column“ and the door- and window-lintel beam

The buckling behaviour of walls depends, apart from the slenderness ratio (parameters: buckling length, effective stiffness), on the load introduction of the compression force (loads-centrally or eccentrically (e.g. at shifted and rotated floor supports)). In multistorey buildings, wall sections have to be considered over the total wall height. The buckling behaviour of the total wall (e.g. uncoupled wall of the stair-case) in multistorey buildings can be considered only over one floor-height due to the high stiffness of the floor. Friction-locked connections of transversal shear-walls also lead to higher buckling forces of the wall to be verified.

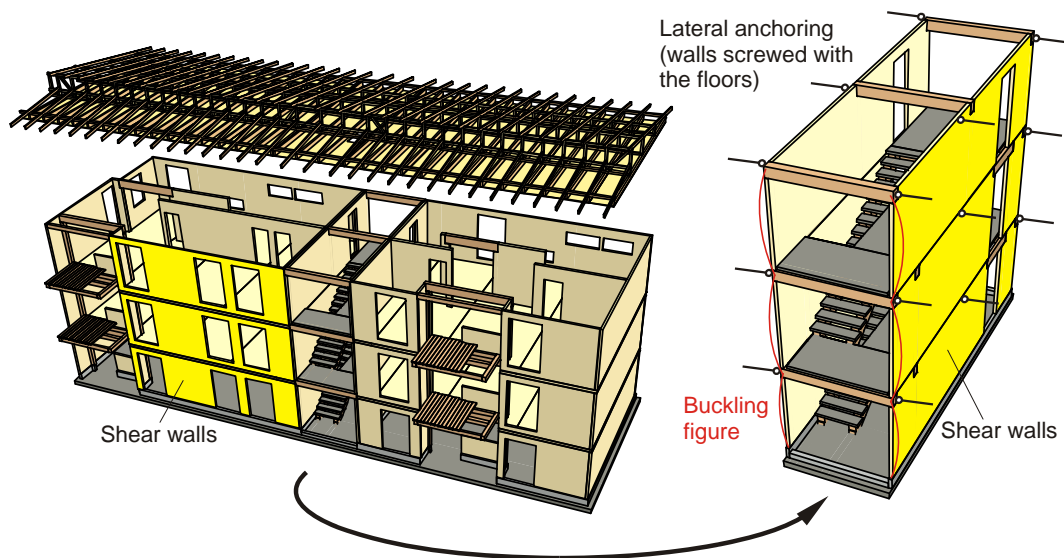

Fig. 6.26 Modelling of the unhinged structural system of the staircase

3.7 Modelling of joints

The modelling of joints for the verification of their load-carrying capacity has to be done under consideration of effects relating to the configuration of CLT-elements.

For the modelling of joints, appropriate load-carrying models for the fasteners (e.g. self-tapping screws, glued-in rods, bolts, etc.) have to be developed.

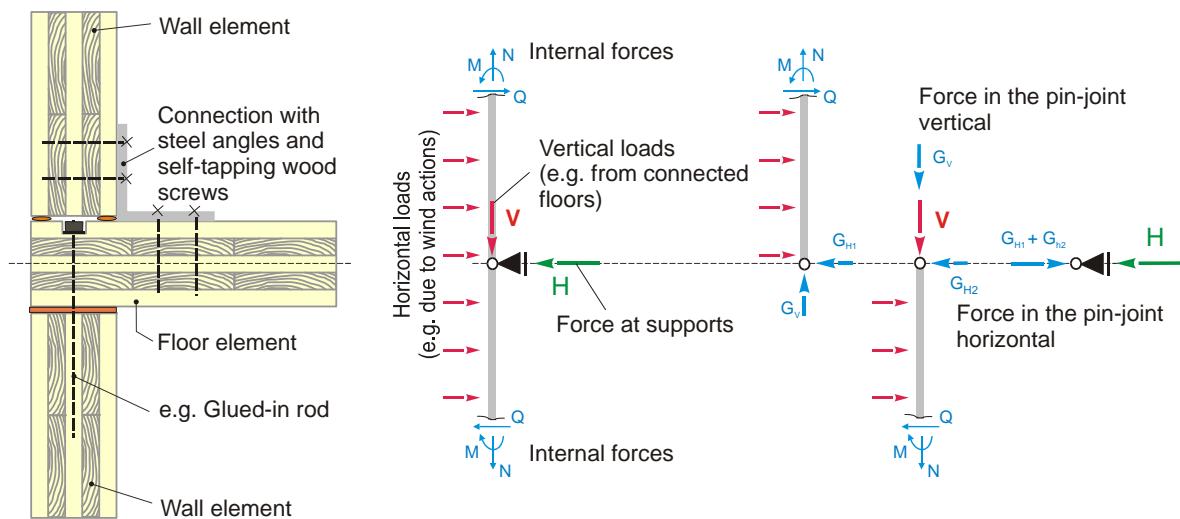

Fig. 6.27 Modelling of the floor-wall-edge by means of vertical displaceable support

3.8 The use of CLT- elements for residential and multi-storey buildings

3.8.1 General aspects

The MTC-system under utilisation of CLT-elements is characterised by the load-carrying use of massive, multi-layered configured elements. Because of their dimensions in width and length compared to their thickness, they can be classified as shell structures (panels, plates) or 2D-elements.

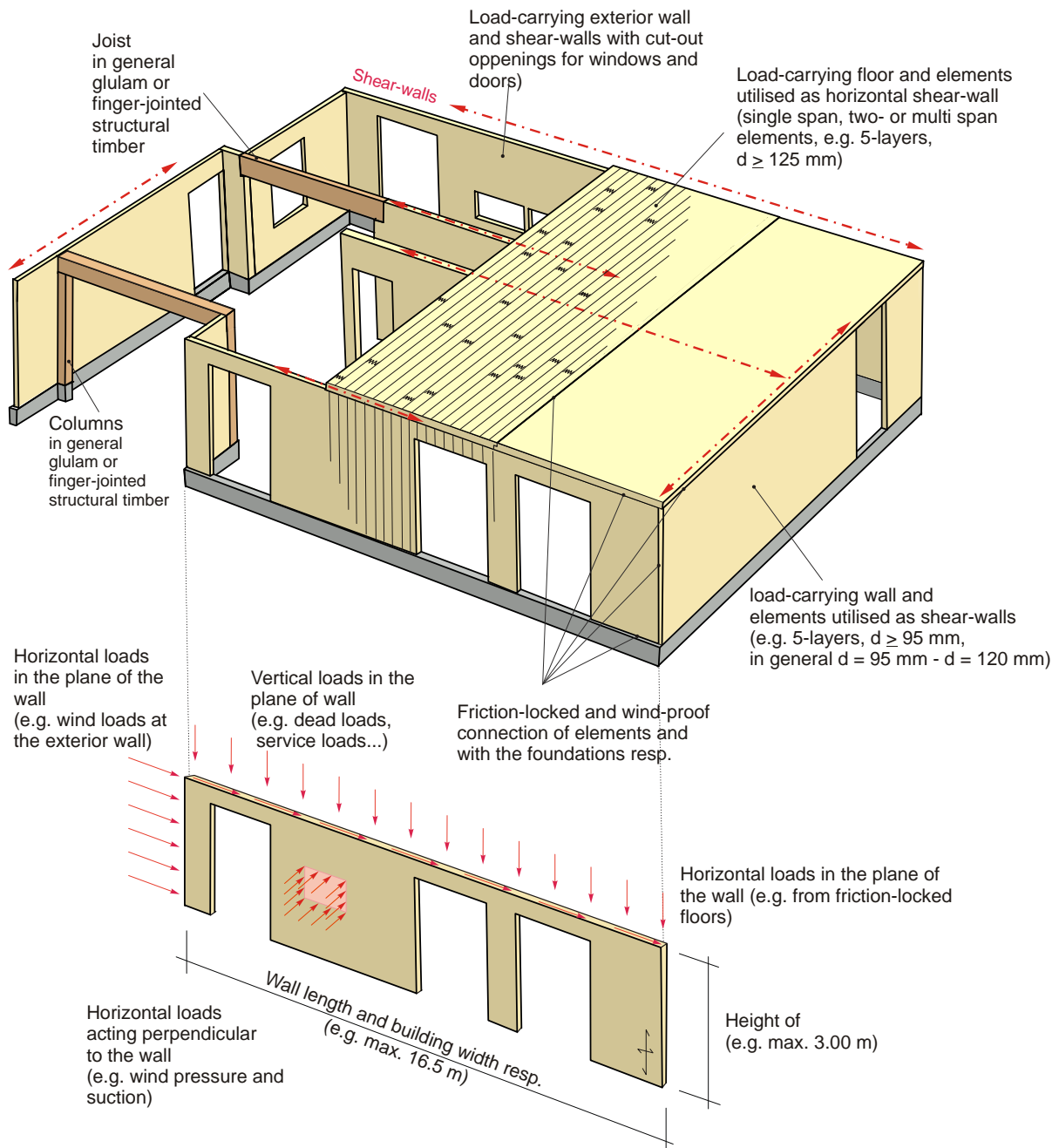

Fig. 6.28 Load-carrying CLT-elements and elements used as shear-walls in residential buildings

Dependent on their loading situation, CLT-elements act as panels or plates. By adaptation of the cross-section – in general with orthogonal layers – an appropriate load carrying capacity can be achieved in the longitudinal and transversal direction. Depending on the configuration of the cross section also a transverse load distribution, e.g. for the introduction of single-loads, can be achieved.

The many purposes for the use of CLT-elements for residential and multistorey buildings are shown by the variability of products and components. Their use is not only limited to big



sized exterior and interior walls, roofs and floors, but also in combination with bar-like elements like joists, upstand beams and columns.



Fig. 6.29 Unfinished building: Erection of walls, lifting of floors



Fig. 6.30 Load-carrying elements and shear-walls in a multi storey building; floors with openings

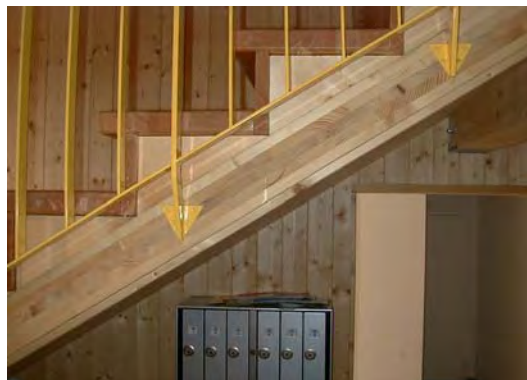

Fig. 6.31 Plate for a stair-case

Walls with window- and door openings, floors with openings for staircases and rebates for roof elements (e.g. for dome lights and sheds) are realisable mostly without additional constructional efforts (e.g. local reinforcements through replacement activities). Depending on the width of window- and door openings, the above arranged floor plate is able to bridge them.



Fig. 6.32 Rebates for the chimney and ribbed CLT-element with domelights

In addition, CLT-elements allow cantilevered and point-borne balcony and canopy elements apart from porches on all sides.

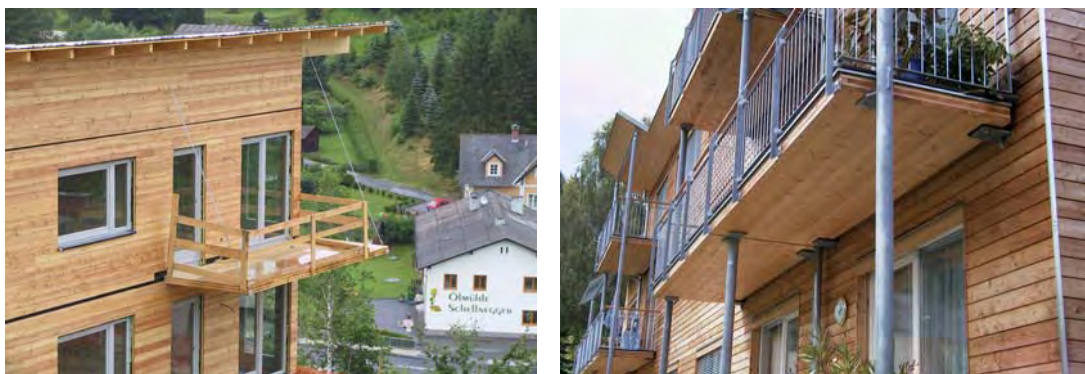

Fig. 6.33 Cantilever and point-bearing balcony plates

As know from experience, the thickness of a 5-layered element for use in multistorey buildings (up to three floors) is about 95 mm. The minimum thickness for load-carrying, massive wall elements is dependent on the span and the product used. In general it should not be below 75 mm as a recommendation.

Depending on the element and floor configuration, dead and service loads spans between 4.0 and 5.0 m can be realised with a 5-layered floor element ($d = 125$ mm up to 160 mm) in an economical way. For bigger floor spans and higher wall elements without supports, ribbed plates built-up with glulam beams or boxed beams with glulam webs can be used.



Ribbed plate,
CLT, 5-s + Glulam (GL24 up to GI36)

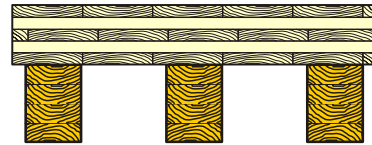

Boxed cross-section,
CLT, 3-s + Glulam (GL24 up to GL36) + CLT 3-s

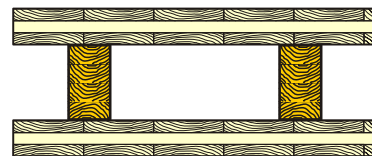

Fig. 6.34 Ribbed plate and boxed cross-sections built-up with CLT-elements

Massive walls, floors and roof elements can be manufactured exactly and according to plans mostly in connection with a standardised and simple connection techniques. Expensive adjustments and fittings on site can, therefore, be omitted. Insulations, formwork and facade elements can be easily connected and quickly assembled on the CLT-element.

A combination with other building systems (e.g. masonry structures) can be done in a simple way.

3.8.2 Realisation of shear walls

The bracing of buildings erected with CLT-elements is done with shear-walls in combination with floors, which lead to a stiff three dimensional structure. Generally speaking, the bracing is not necessary. Horizontally loaded shear-walls need necessarily friction-locked connections with the floor. The required number of shear-walls and their position within the building is determined by the geometry of the building, the cross section of the members, the geometry of the single shear-walls and the type and magnitude of the horizontal loading (actions trough earthquake, wind, etc.).

Regarding horizontal load transfer, apart from the type of fasteners used, the unaffected length of the shear-wall (length : height – ratio of the wall) is of significance. Large wall openings, e.g. for windows and doors, which interrupt the vertical and/or horizontal load transfer lead to disturbances in the shear-wall properties.

Massive shear-walls are in general stiffer than lightweight wall constructions. Due to this fact, the number and length of shear-walls can be significantly reduced.

3.8.3 Aspects for the fire protection of CLT-elements

CLT-elements consist of different layers produced with the organic material, wood and timber respectively, which can burn. Despite this fact, the behaviour of CLT-elements in the case of the affects of fire can be judged as favourable. This is because the outermost charred layers built-up a heat protective zone (“pyrolysis layer”) that protects the underlying layers of the

element. As a result, heat increases slowly and the fire is delayed. The decreasing load carrying capacity is a result of the decreasing cross-section of the burned member.

In comparison with structural timber and glulam, the charring rate is higher due to possible gaps between the boards making-up the layers. Furthermore, the outermost layer can bust from the layers of the element, which leads to an increased charring rate of CLT-elements too.

Within the verification process, the loss of the outermost layer has to be considered. This means that for a five layered element in the case of 30 min. fire exposure, there is a possibility that at least one layer is burned away. A five layered element with three layers in longitudinal and two layers in transversal direction is, therefore, reduced to a three layer element after exposure to fire for 30 min. This configuration is preserved for a further 30 min., afterwhich the next transversal layers are exposed to being burned out.

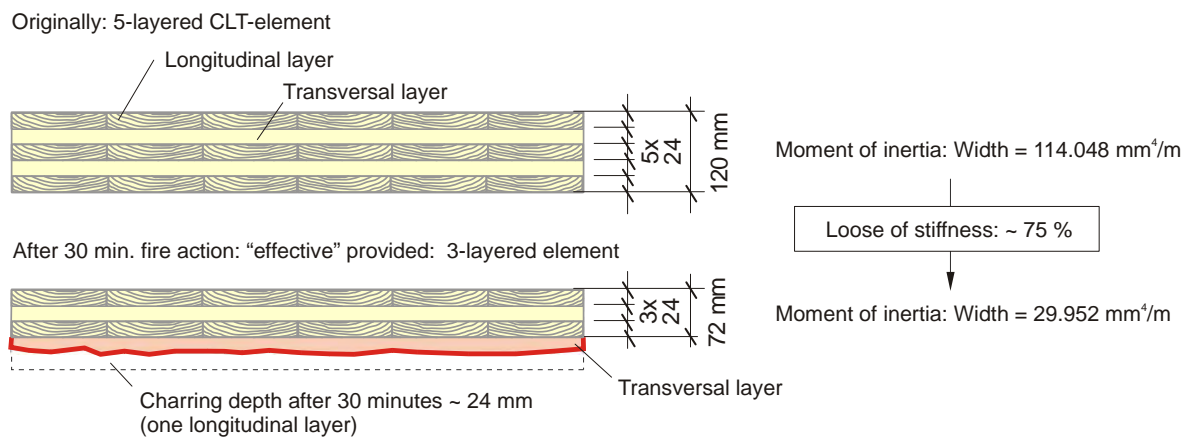

Fig. 6.35 Loss of stiffness of a one-sided, fire exposed CLT-element

Tests with a 120 mm thick and 5-layered CLT-element have proved resistance to fire of 60 min. can be achieved without losing the necessary load-carrying capacity and without problems. With the appropriate design (e.g. of the outermost layer) and/or additional cladding of the CLT-element with panels (e.g. gypsum boards), even higher durations can be achieved.

3.9 Connection technique for CLT- Elements

3.9.1 General aspects

By using large-sized elements in MTCs, only a few contact edges appear. These edges can be separated in Wall-Wall, Wall-Foundation, Wall-Floor-Wall and Floor-Floor-edges. The necessary friction locked and leak-proof connection of the single, large-sized CLT-elements is generally achieved by means of (conventional) mechanical fastener systems.

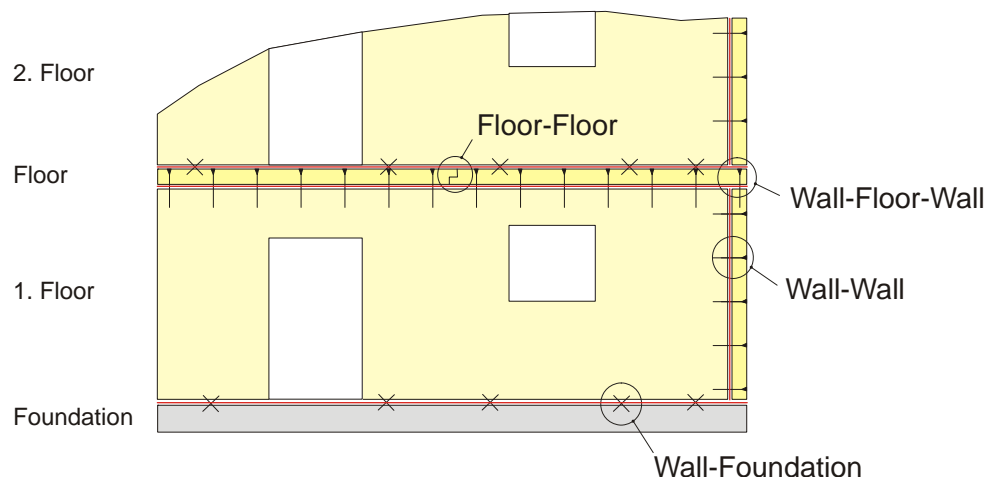

Fig. 6.36 Position of edges in multi stores buildings

The design of joints for CLT-elements in the aforementioned edges and the verification of their load-carrying capacity is usually done by means of well known fastener systems at discrete points. The usual fasteners for this purpose are, e.g. self-tapping wood screws, glued-in rods, nails, dowels and bolts. In addition, other fastener systems that are technically approved can also be used.

At the wall-floor and wall-foundations-edges in general, compression stresses occur due to the own-weight of the structure. Only for loading situations with low compression forces, e.g. in the case of (temporarily) erection-loading situations and/or special geometries of the members, can lifting forces in the contact edges appear. These tensile forces have to be carried by appropriately designed joints.

For the placing of these joints and the design of their load-carrying capacity, the configuration of the element cross section has to be considered.

- On the main surfaces of the elements, consideration must be taken as to which layers the fasteners are to be arranged
- Regulations for spacings and edge distances, embedding lengths, predrilling, etc., which are valid for the fasteners considered, in compliance with the load-to-grain angle, must be taken into account in accordance to the specifications for structural timber and glulam. Any gaps appearing between the boards of a layer (due to the production process or unglued board edges and cracks) have also to be considered.



- Because of the layered cross-section and the orthogonal aligned layers (0° , 90° , 0° , 90° , ...), a different load-carrying and stiffness behaviour, compared with bar-like products, can be expected. For the fasteners, self-tapping screws, glued-in rods, dowels and bolts in question, it is necessary to postulate appropriate load-carrying models. These models are currently developed. An aiding experimental evaluation of the connection technique used is necessary.

3.9.2 Wood screws

Transversally loaded wood screws must exhibit at least a nominal diameter d_s of 4 mm. In addition, at least four shear planes are required. If the diameter is above 10 mm this requirement is decreased to at least two shear planes. Screws in the face surfaces of CLT-elements can be applied when these regulations are followed.

Edges that border gaps of the layers have to be taken into account as for end distances. Under consideration of gaps in the inner layers, only the outermost layer can be considered in the design of such joints. Because of this fact it is advantageous that the elements are built-up with boards which are glued on their narrow side too. For these elements, the appropriate layers for the connections can be taken into account under consideration to their orientation.

A high performance, simple to apply and, therefore, economical solution is the use of self-tapping wood screws. They are available in diameters of 8 mm, 10 mm and 12 mm and are available in lengths up to 600 mm. The use of these can be achieved without pre-drilling and inclining the screw angle between the axis of the fastener and wood's grain. In general self-tapping wood screws are loaded axially, which allows for the transfer high loads.

3.9.3 Glued-in rods

Glued-in rods are an appropriate fastener-system for the connection of CLT-elements. They allow a defined connection of the narrow sides, in particular for the transfer of higher loads and when loads occur transversal and longitudinal to their axis.

If the narrow side of the boards in the single layers is not glued it can not be avoided that parts of the rod are positioned in gaps where they of course can not transfer loads. As a consequence the load-carrying capacity can strongly decrease.

3.9.4 Dowels and bolts

Dowels and bolts – loaded transversal to their axis – can be used also for load-carrying joints of CLT-elements. It is required that the orientation of the layers in the cross-section is considered. In elements with unglued narrow faces, it cannot be ruled out that fasteners are located in gaps between the boards. Consideration must be taken that the load-carrying capacity is influenced not only by the outermost layers, but also by the configuration of the cross section (orientation and thickness of the layers).



3.9.5 Nails, split rings and shear plate fasteners

These connectors have not been used for the connection of CLT-elements recently.

The use of nails, in particular of grooved and helical threaded nails, mostly in combination with steel angles can be achieved under consideration of aforementioned requirements. Nailed joints at the narrow surface for the connection of elements are not allowed in accordance to the regulations of known codes.

Split rings and shear plate fasteners can be used for the jointing of CLT-elements, but it has to be considered that, dependent on the position of the fasteners with regard to the layers, a significant decrease of the load-carrying capacity has to be taken into account.

3.10 Details of joints

3.10.1 General aspects

All contact edges have to be sealed with appropriate products (sealing bands and -sheathings, rubber profiles etc.) to achieve an air- and dust-tight edge of the elements. Also the requirements regarding sound insulation have to be considered. The design of the edges has to be made in accordance with the requirements of the used product. Furthermore, it is necessary to pay attention to the sealants need an adequate pressure to achieve proof-joints. Using fasteners at edges as proofing of these same edges is not permissible.

In all contact areas deformations of the sealant products and deformations due to shrinkage and expansion of the CLT-elements can occur. In particular perpendicular to the CLT-elements (radial shrinkage and expansion) can reach higher amounts. A locking of shrinkage and expansion effects due to moisture changes should be avoided. The designer should consider deformation diagrams for the sealant products and information about shrinkage and expansion behaviour of the used CLT-product.

Due to tolerances in the geometry of the elements, but also because of uncertainties in the erection of the structure, reliable settlement and other deformation values for the friction coefficient are often unknown. The positive effect of the friction between elements should, therefore, not be taken into account within the verification process.

In principle, an appropriate system for self-aligning of the elements during the erection should be foreseen. This makes the assembly process easier and gives the possibility to team the elements.

The following sketches illustrate so-called "leading-details" for the most important edges of CLT-elements used for residential buildings (use of floor height elements). Other important details can be obtained, e.g. from: <http://www.bauphysik.tugraz.at/aktuelles/pdf/bph5.pdf>

Most of the proposals assume gluing at the narrow side of the used boards in a layer. If this is not possible, it must be done by other means (e.g. the use of foil and membranes). The position of the single joints and fasteners, respectively, has to be done according to the structural design.

3.10.2 Joints for floor-floor-edges

Due to production and transport considerations, elements with limited width are manufactured (dependent on the product from 3.0 up to 4.0 m). For floors with greater dimensions it is necessary to connect the single elements. One possibility is the screwed half-lap joint. This joint can carry normal and transversal loads but is not able to transfer moments. In general it is used to connect the longitudinal edges of the single CLT-elements. In particular, if uneven loading on the floor occurs, there is a risk of splitting of the cross-section due to tensile or compression stresses perpendicular to the grain. Because of this, a pin-like fastener has to be considered.

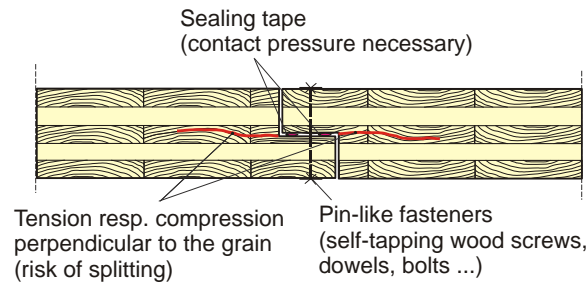

Fig. 6.37 Joint for the floor-floor-edge (not moment resisting)



Fig. 6.38 Floor-floor-joint

By using a stripe consisting of an engineered wood product (e.g., 3- or more layered plywood, KERTO-Q), the joint can also be loaded by moments. These stripes are screw or nail-glued to the CLT-members.

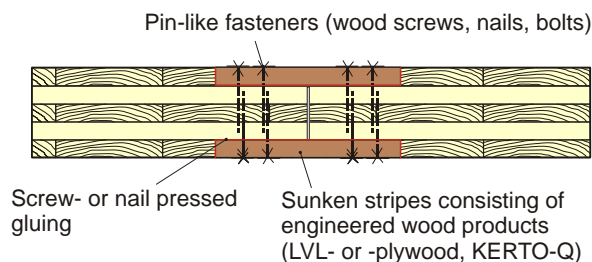

Fig. 6.39 Joints for floor-floor-edges (moment resisting)

3.10.3 Joints for wall-floor-edges

Possibilities for the connection of walls to the floor above can be achieved by means of steel angles, joints with self-tapping wood screws and glued-in rods. With these fastener systems, horizontal loads (e.g. due to wind forces) can be transferred into the floor plane. In addition, also lifting forces on the wall elements can be carried.

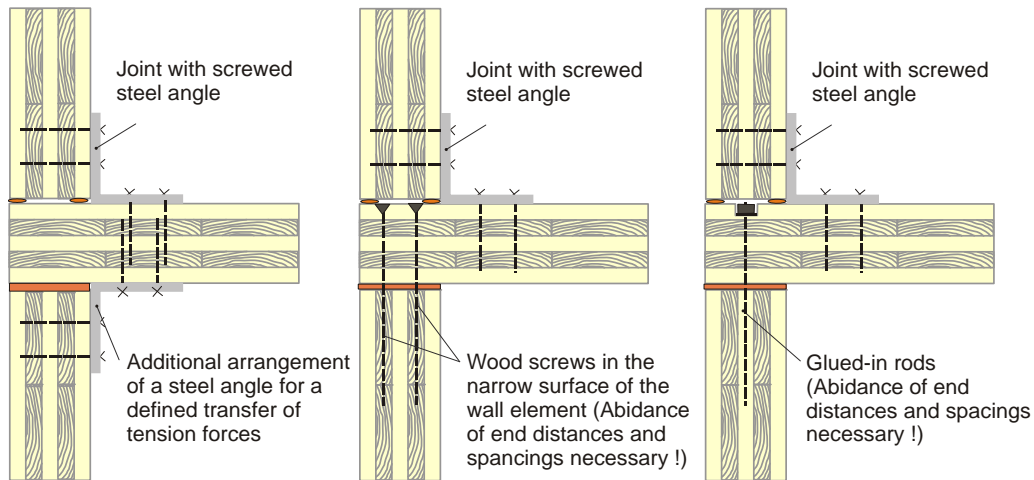

Fig. 6.40 Joints for wall-floor-edges

The connection of elements in the wall-floor-edges can also be achieved by means of wooden profiles. As a material, LVL profiles of the wood species oak and robinia can be used. Local openings in the plane of the floor allow also the use of glued-in rods.

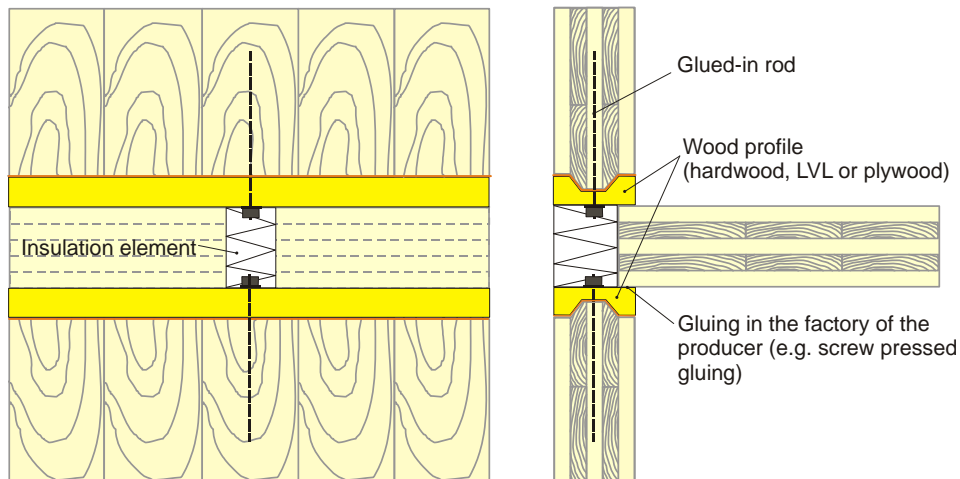

Fig. 6.41 Joint for wall-floor-edges with glued-in rods

A direct connection of the floor with the wall elements below them with wood screws should be avoided because of the danger of positioning the fasteners in the end-grain. In addition to load-carrying purposes, screwed joints with diameters $d_s < 10$ mm and at least four shear planes are needed.

3.10.4 Joints of the wall-wall-edges at corners

This joint can be made in different ways using self-tapping wood screws.

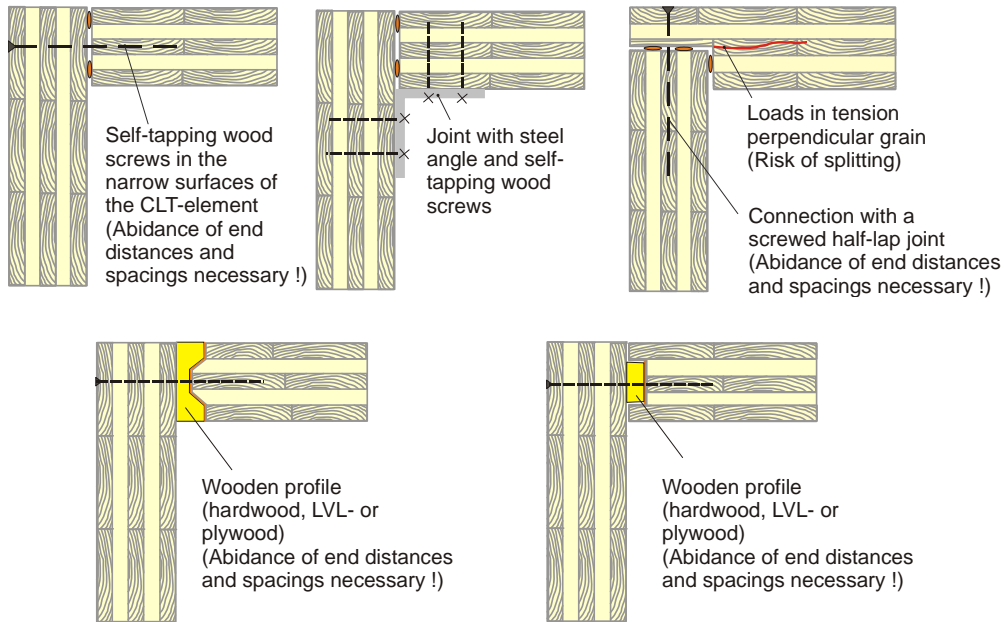

Fig. 6.42 Different possibilities for the design of wall-wall-edges at corners

Another possibility for the design of the joint for wall-wall edges with corners is achieved using special profiles (hook or dovetail joints) consisting of wood or steel and with "system fasteners" (similar to those used in the furniture industry). With an appropriate prearrangement, these joints allow an easy assembly on the building site due to a self-aligning mechanism.

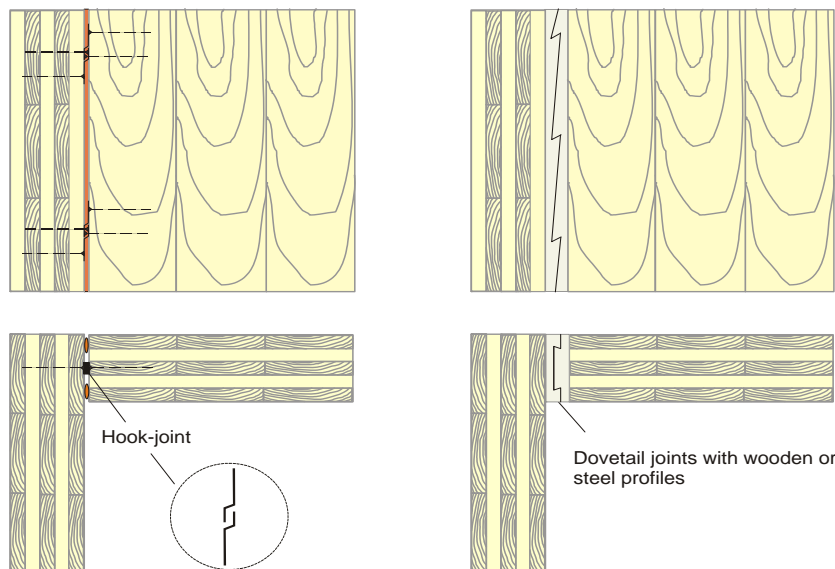

Fig. 6.43 Joints for the wall-wall-edge with corners

3.10.5 Joints of the wall-foundation and wall-concrete floor-edge respectively

For the connection of CLT-wall elements with the foundation and concrete floors, different options are available. In general these joints are implemented by means of steel plates and/or steel angles with wood screws as fasteners in the CLT-elements. For reasons of wood preservation and the adjustment of tolerances, wooden profiles (hardwood) or profiles consisting of wood engineered products (LVL or plywood etc.) can be used.

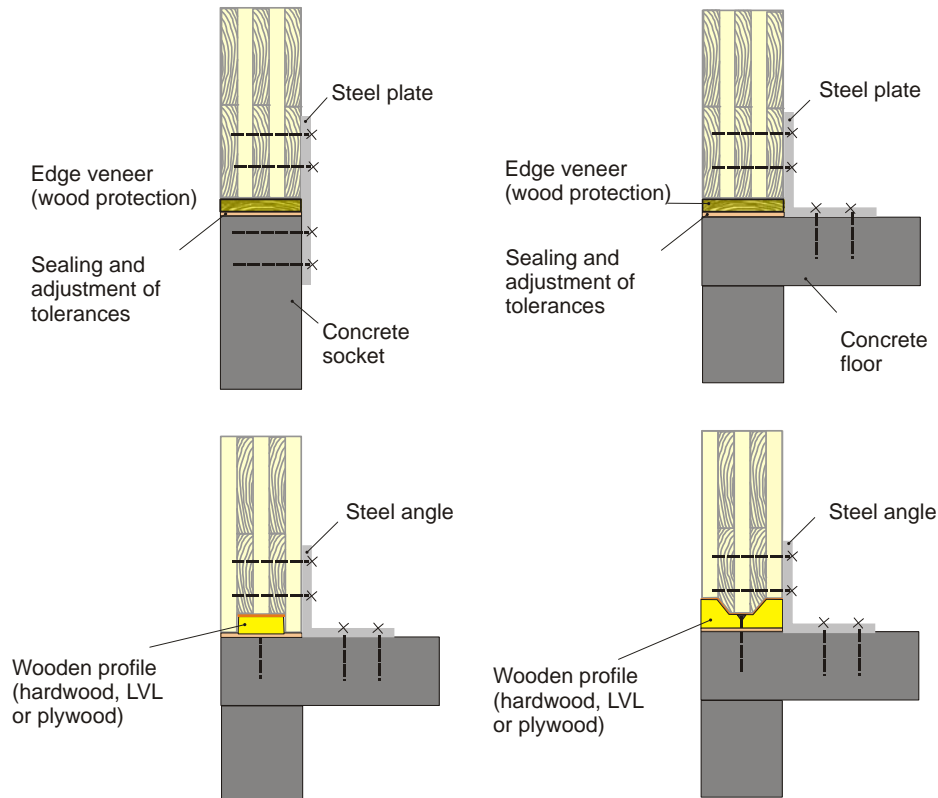

Fig. 6.44 Different possibilities for the design of joints in the wall-foundation- and concrete floor-edge

3.10.6 Special connectors for CLT-elements

Wall-Floor-Wall connections can be realised also by means of glued-in rods, which are glued at the production hall. During the erection of the building, the CLT-elements are aligned by special steel rings, which team the element and are fixed by conventional steel nuts. This connection method can be used for big elements and are currently still being developed.

In addition, so-called “system fasteners“ can be used. These fasteners are very similar to those used in the furniture industry. Of course, they are adapted to the higher loads and bigger elements. Besides their load carrying purposes, these fasteners can be multifunctional, e.g. as interfaces for bus-systems and other housing technical tasks. As a consequence, a very high level of prefabrication can be achieved.



4 References

- [1] Ranta-Maunus, A.;
“Laminated veneer lumber and other structural sections“,
Chapter A9 from “STEP 1 – Timber Engineering“; First Edition, Centrum Hout,
The Netherlands, 1995
- [2] Steck, G.;
“Wood-based panels – Plywood“,
Chapter A10 from “STEP 1 – Timber Engineering“; First Edition, Centrum Hout,
The Netherlands, 1995
- [3] Griffiths, R.;
“Wood-based panels – Fibreboard, particleboard and OSB“,
Chapter A11 from “STEP 1 – Timber Engineering“; First Edition, Centrum Hout,
The Netherlands, 1995
- [4] Schickhofer, G.; et.al.
“Holzbau – Der Roh- und Werkstoff Holz, Part A“,
Lecture notes, Institute for Timber Engineering and Wood Technology, Graz
University of Technology, Graz/Austria, 2004 (in German)
- [5] Porteous, J.; Kermani, A.;
“Structural design to Eurocode 5“,
Blackwell Publishing Ltd., Oxford, UK, 2007
- [6] McKensie, W.M.C.; Zhang, B.;
“Design of Structural Timber to Eurocode 5“,
Second edition, Palgrave Macmillan, UK, 2007
- [7] Tsoumis, G.;
“Science and Technology of Wood – Structure, Properties, Utilization“,
Van Nostrand Reinhold, New York, USA, 1991
- [8] Kollmann, F.F.P.; Kuenzi, E.W.; Stamm, A.J.;
“Principles of Wood Science and Technology, Volume II: Wood Based Materials“,
Springer, Berlin-Heidelberg, Germany, 1975
- [9] pro:Holz Austria (Ed.);
“Mehrgeschossiger Holzbau in Österreich, Holzskelett- und Holzmassivbauweise“,
ISSN 1680-4252, pro:Holz Austria, Vienna, Austria, 2002 (in German)
- [10] Jöbstl, R.A.; et.al.
“A Contribution to the Design and System Effects of Cross Laminated Timber (CLT)“,
Paper 39-12-4, Proceedings of CIB-W18, Florence, Italy, 2006
- [11] Jöbstl, R.A.; Schickhofer, G.;
“Comparative Examination of Creep of GLT- and CLT-slabs in bending“,
Paper 40-12-3, Proceedings of CIB-W18, Bled, Slovenia, 2007



- [11] Schickhofer, G.; Moosbrugger, T.; (Ed.)
“Brettsper Holz – Ein Blick auf Forschung und Praxis“,
Proceedings, Graz University of Technology, Institute for Timber Engineering and
Wood Technology, Graz, Austria, 2006 (in German)

- [12] Guggenberger, W.; Moosbrugger, T.;
“Mechanics of Cross-Laminated Timber Plates under Uniaxial Bending“,
Paper, Proceedings of the 9th World Conference on Timber Engineering, Portland,
Oregon, USA, 2006

- [13] Moosbrugger, T.; Guggenberger, W.; Bogensperger, T.;
“Cross-Laminated Timber Wall Segments under homogeneous Shear – with and
without openings“,
Paper, Proceedings of the 9th World Conference on Timber Engineering, Portland,
Oregon, USA, 2006

Chapter No. 3 has been prepared by Manfred AUGUSTIN, Institute for Timber Engineering
and Wood Technology, Graz University of Technology / Austria.



DESIGN OF TIMBER STRUCTURES

1 Introduction

The chapter deals with an outline of the philosophy of design and assessment of the reliability of timber structures. Terms, such as reliability of structures, limit states, load actions, computational models, reference values and methods of verification of reliability of structures are defined.

2 Design of Structures

Design of building structures is a process based usually on rational thoughts coming out of requirements the designed structure must comply with. It is a multilevel process. One of the most important parts of the process is assessing the reliability of the designed structure.

In general, **reliability of a structure** can be understood as being an ability of the bearing system to maintain required characteristics for a predetermined period of time of its technical life (= **serviceability**). Failure corresponds with a state when the structure loses its required functions. **Failure** is then a loss of required characteristics.

Design methods and assessment of reliability of structures conform mainly to the knowledge level and technical (computational) abilities at the time of their origin. Since the 19th century, the quality and efficiency of such methods have increased hand in hand with the increase of the amount and depth of knowledge about materials structure, their behaviour in different (often limit) situations, about load actions and last, but not least, also with the development of permanently more and more perfect computational methods, which describe stress states and deformation of structures. In the last decades this trend has been enhanced by riotously developing computer technology.

3 Limit states design

The process of reliability assessment of a structure can be divided into two parallel areas of solution. In the context of the outline the philosophy of limit states, two characteristics are investigated – **load actions** and **structural resistance**. Subsequently, interaction of these two quantities is analysed. In particular, it must be verified that the effects of design actions do not exceed the design resistance at the ultimate limit states and that the effects of design actions do not exceed the performance criteria for the serviceability limit states.



- Within the investigation of load actions it is necessary to:
 - determine all **loads** affecting the structures and their combination in the course of expected working life,
 - choose a suitable **computational model** for the determination of response of the structure,
 - determine a **response of the structure** on load and its time course.

- Within examination of resistance of a structure it is necessary to:
 - determine material characteristics,
 - determine geometric and cross-section characteristics of the structure,
 - determine **reference values** that the testing of probability of failure origination will relate.

In the process of reliability assessment it is usually necessary to consider rheological characteristics of the material, effects of geometrical and materials imperfections as well as degradation agents, etc.

Reliability assessment of structures can be divided as:

- **safety** assessment,
- **serviceability** assessment.

3.1 Action on Structures

Structural loading is a physical quality that affects structures and evokes a change of stress state and deformation on the structure. Load can appear on the structure as a **force** (in a form of forces and moments) or a **deformation** (i.e. in a form of enforced deformations caused by temperature changes, mining activities, flooding etc.).

The actions can be classified according to different criteria. The relevant criteria will be related to the considered situation. One obvious classification is that included in the definition given of actions: direct or indirect actions. Other criteria are:

- by their variation in time: permanent, variable or accidental,
- by their spatial variation: as fixed or free or
- by their nature and/or the structural response: as static or dynamic.

Different kinds of actions are those called environmental influences. There are also bounded actions, those that there have bounds that can be known, and unbounded.



3.1.1 Actions by their variation in time

The most important classification of actions is referred to the time the action is acting compared with the reference period. These actions are classified as:

– Permanent action (G)

Action, that is likely to act throughout a given reference period and for which the variation in magnitude with time is negligible, or for which the variation is always in the same direction (monotonic) until the action attains a certain limit value; e.g. self-weight of structures, fixed equipment and road surfacing, and indirect actions caused by shrinkage and uneven settlements.

– Variable action (Q)

Action, for which the variation in magnitude with time is neither negligible nor monotonic, e.g. imposed loads on building floors, beams and roofs, wind actions or snow loads.

– Accidental action (A)

Action, usually of short duration that is unlikely to occur with a significant magnitude on a given structure during the design working life, but its consequences might be catastrophic, e.g.: earthquakes, fires, explosions, or impact from vehicles.

The reference period is the time used as a basis for the statistical assessment of the actions and the time varying resistances. That means that the action has a “working life” of the structure which could be split in some reference periods, of the same length or of different (random) length. Since the actions vary in a more or less similar pattern; i.e. their characteristics could be adopted by independent, identical distribution functions in any of such reference periods. Therefore, the maximum in each period corresponds to a realization of the same distribution function of maxima.

The adequate reference period depends on the kind of actions: for climatic actions – snow, wind, etc. – a period of a year is, in general, adequate; i.e.: can be assumed that each annual maximum is independent of the maxima of previous years and next year.

For other variable actions, like imposed loads, the period corresponding to a change of use or a change of owner may be more adequate. In this case, the action can be represented by a Poisson’s process where both the length of the reference period and the values in each period are random. The average rate of change is generally assumed between 5 to 10 years depending on the use of the building.

For permanent actions, the reference period is taken generally the whole working life of the structure, and so is stated in EN 1990 for the self-weight of the structure itself. However, EN 1990, talking in terms about permanent actions, makes a distinction between the reference period and the working life for the self-weight of the structure.



This distinction could allow that, sometimes and for some types of actions, like the self-weight of machinery or of partitions, these actions be considered permanent on a reference period shorter than the working life of the structure, and change of values in other reference periods, corresponding e.g. to a change of use and/or the owner. The assumption in this case is that the variation in between each one of these reference periods is very small, but the variation could be important in different reference periods. With this assumption, distribution functions similar to those given for the variable imposed loads are obtained.

Sometimes, the classification of one action as accidental or variable depends on the site or the magnitude registered. For example: a seismic action will always be accidental in most European areas, but in areas prone to seismicity, as Japan, California or some areas of Europe, a seismic action up to a certain magnitude can be considered a variable action, while “the big one” earthquake will be considered accidental. The same can be applied to other kinds of actions as wind or snow (see EN 1991 and EN 1998).

3.1.2 Actions by their origin

Included in the definition of actions are these two classes: direct actions: forces (loads) applied to the structure, and indirect actions: imposed deformations or accelerations caused for example, by temperature changes, moisture variation, uneven settlement or earthquakes.

An action has a fixed distribution and position over the structure or structural member such that the magnitude and direction of the action is determined unambiguously for the whole structure or structural member this a fixed action. If the action may have various spatial distributions over the structure is a free action.

3.1.3 Actions by their nature or structural response

The static actions are those that do not cause significant acceleration of the structure or structural members, while dynamic actions cause significant accelerations of the structure or structural members. In most cases for dynamic actions, it is enough to consider only the static part of the action, which thereafter may be multiplied by a coefficient to take account of the dynamic part.

Ultimate limit states are strictly correlated to bearing ability or, in any event, to the attainment of extreme conditions, and therefore refer to all those situations that can compromise people’s safety, safety of the structure and, in exceptional circumstances, the potential contents.

Serviceability limit states are instead related to the criteria governing construction functionality, the requirements for durability and ordinary usage, user comfort and the structure appearance. Within the framework of serviceability limit-state verifications, three different aspects to be considered are distinguished: deformations, vibrations and damage.

Within the issue of load analysis, also combinations of loads in the course of life (serviceability) in different situations should be mentioned – as well as the issue of present extreme values of single loads.



3.2 Computational models

Computational models serve the issue of determination of response of the structure on loading (i.e. for investigation of load actions). Selected models should define properties and behaviour of the construction as accurately as possible. Apart from the principal quantities, such as geometric, materials and cross-section characteristics, it is also necessary to take into consideration production and assembly imperfection, environmental effects and other effects when selecting a certain model.

Physical models serve for experimental determination of bearing capacity, usability or serviceability of the structure. These experiments serve both for verification of credibility of theoretical models and they can, in certain cases, replace theoretical models.

The results of experiments can be used for the design of extraordinary structures or for the design of structures in a wider scale, including creation of rules in standards for structural design.

Theoretical models are basic models in structural design. They are divided into analytical and numerical models. Analytical models are commonly used in project engineering and in regulations for designing. Numerical models usually serve for the description of properties of more complicated structures and their behaviour in different situations.

The basis of **analytical models** is a formulation of the problems by a system of equations and their solving in a closed form. Analytical models can help to solve quite a wide range of problems – from one-dimensional (bar constructions) and two-dimensional (walls, plates) to three-dimensional structural elements and details. However, it is necessary to realize that analytical solution requires quite a lot of theoretical knowledge due to its mathematical exactness and it is convenient only for the simpler cases of loading, shape and supporting of structures. Finding exact analytical solutions in generally more complicated cases is usually very difficult, sometimes even impossible. In such cases, numerical methods are involved, which are continuously elaborated and made perfect.

The principle of **numerical methods** is a formulation of a problem by a system of differential equations, which are not, however, solved in a closed form. The solution is searched for by various numerical methods (variation methods, differential methods etc.). Modern numerical methods (the most widespread representative is Finite Element Method) are predominantly “energetic” methods, which means methods based on searching for the extreme of potential energy of a structure. These methods are based on idealization of a continuous structure by discrete elements with certain geometric and physical properties.



Another possible way of dividing computational models is the division into:

– Static models

Load affecting the structure evokes insignificant acceleration. We distinguish static models with time dependent load or time independent load.

– Dynamic models

These models are used in cases when load evokes a response characterized by a non-negligible acceleration. In most cases, load changes its size, location or direction in time.

– Complex models

They are used in cases when static or dynamic response of the structure is accompanied by time dependent phenomena, such as fire, creep, and brittle fracture of steel, accumulation of failures and creeping of timber-based materials.

The computational models can also be evaluated from the view of material models. In principle we distinguish between:

– Elastic models

They are a subset of more general elastic-plastic models and they are used with models where load evokes lower level of load and the response does not evoke any plastic (which means irreversible) deformations.

– Elasto-plastic models

These, more general models, accept plastic behaviour of the material. However, it is necessary to keep in mind the fact that bearing capacity and deformation in the plastic area must fluctuate within certain tolerated limits and reference levels, which are the subject of normative regulations.

It is also necessary to distinguish whether the computational models are based on the examination of a non-deformed structure – according to the theory of small deformations (**1st order theory**) or investigation of a structure, when initial deformations are taken into account and conditions of equilibrium are assembled on deformed structures (**2nd order theory**).

3.3 Material and geometrical characteristics

These characteristics are the basis for the determination of structural resistance. It is necessary to respect and describe the variability of properties of structural materials and geometric characteristics. The variability is caused by the influence of various imperfections of natural origin as well as in the processing phase, building the material into the structure and by external effects during the structure life. Various methods of structural designing consider those phenomena in different ways.



3.4 Reference values

In the process of reliability assessment, it is necessary to set **reference values** such as values for stress, strain or deformations. After exceeding the values, the structure of the relevant part will discontinue fulfilling the designed requirements and will become dysfunctional or even dangerous.

3.5 Influence of technology, environmental conditions and manufacturing process

Rheological effects, such as creeping and shrinkage, and environmental effects, such as atmospheric corrosion, bio corrosion, quality of production, assembly and maintenance should, if possible, be considered in computational models. Their influence and character are ordinarily a time function.

3.6 Reliability assessment

Methods of reliability assessment of structures can be divided according to many aspects: historical, mathematical etc. In principal, the methods of reliability assessment can be divided into **deterministic** methods (based on safety coefficient) and **semi- or fully probabilistic** methods (based on philosophy of limit states and methods of mathematical statistics and probability).

Historically, the oldest method of timber structures design and their reliability assessment dates back to the 19th century. This is called the Method of Allowable Stresses. This classical method is based on deterministic conception of reliability assessment.

The basic principle on which the philosophy of **allowable stresses** is based can be interpreted by the following expression

$$\sigma_{\max} \leq \sigma_{\text{allow}} \quad (7.1)$$

at the same time

$$\sigma_{\text{allow}} = \frac{\sigma_{\text{crit}}}{k} \quad (7.2)$$

According to relation (7.1), the maximum tension caused by load (σ_{\max}) must be smaller or equal to allowable stress (σ_{allow}). Stress σ_{crit} is stress determined on the basis of tests, and k is the coefficient that involves all uncertainties – both on the side of load and resistance of materials. Its goal is to provide the sufficient reliability for the whole structure. The method of allowable stresses has some important defects – limitations.

Load, materials and cross-sectional characteristics are set in a deterministic way. Response of the structure is examined by theory of elasticity. Uncertainties of the system and its qualities are not explicitly specified. They are considered implicitly in conservative



assumptions on distribution of stresses, in a way of load determination and in a way of determination of allowable stresses.

The method of allowable stresses was a part of standards for designing of timber structures in most countries in the course of the past 150 years. In this method, gradual development both in the sphere of theory of structures and strength of materials occurred.

In the second half of the 20th century, a gradual segue from fully deterministic and overly simplified methods to the **method of partial coefficients** had started in the sphere of reliability assessment of structures, including timber structures. Several reasons led towards a change towards this method. The method of partial coefficients enables more consistent assessment in case of application of the 2nd order theory, use of plastic reserves and clearer perception of load. In this method, uncertainties (distribution of random variable quantities that influences the result) are divided both to the side of load actions and resistance of the structure.

The current Eurocode standard for designing of timber structures (EC 5; its preparation started in 1980s) is based on a method of partial coefficients, which means on a simplified application of philosophy of limit states where characteristic values of load actions, materials characteristics and geometrical quantities are adjusted by partial coefficients.

According to the method of partial coefficients structural reliability assessment is based on philosophy of so called **limit states**. When exceeded, the structure does not meet the designed requirements. There are two groups of limit states:

– **Ultimate limit states (of safety and durability)**

Related to prevention of structural failure creation that could compromise people's safety and give rise to property damage.

– **Serviceability limit states**

Related to the fulfilment of operational requirements specified by the object user or determined in hygienic regulations, etc.

The basic condition for the reliability assessment of the bearing element in the ultimate limit state can be generally defined in the following expression (Fig. 7.1):

$$S_d \leq R_d \tag{7.3}$$

with

S_d is the design value of the actions (expressed by internal forces, stresses etc.);

R_d is the corresponding design value of resistance (with timber structures this value is related mainly to designed strength of timber).

The basis principle for reliability assessment of a bearing element in serviceability limit state can be generally defined in the expression:

$$S_d \leq C_d \tag{7.4}$$

with

S_d is the design value of the actions (expressed by deformation, acceleration etc.);

C_d is a prescribed value of corresponding properties of a structure.

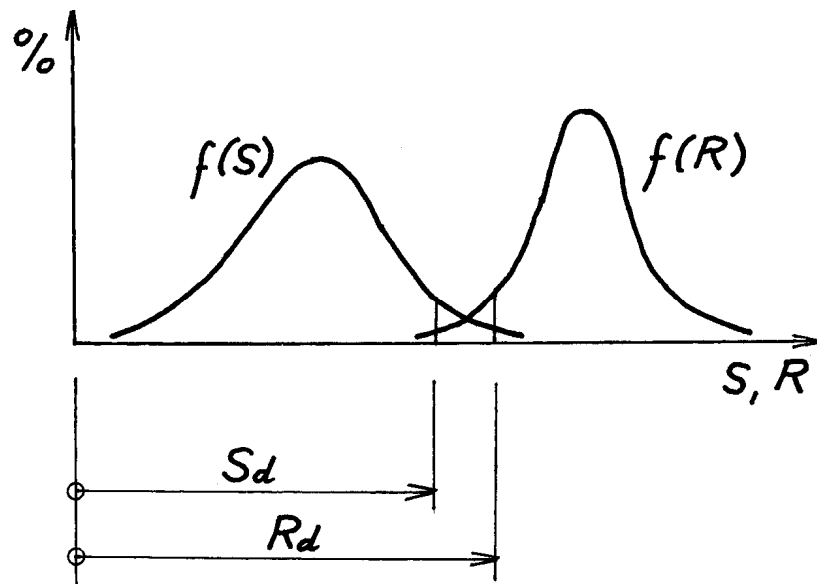

Fig. 7.1 Philosophy of Partial Factor Design

4 Conclusion

The design of timber structures has been currently done according to the same principles as with other load-bearing building materials (steel, concrete, composite) based on the philosophy of limit states and the method of partial factors.



5 References

- [1] Marek, M.P., Brozetti, J., Guštar, M., Tikalski, P., (ed.);
“Probabilistic Assessment of Structures using Monte Carlo Simulation – Background, Exercises and Software”,
2nd Edition, ITAM CAS Praha, 2003, 472 pp.
- [2] “EN 1990 Eurocode 0 – Basis of Structural Design”,
CEN 2002
- [3] “EN 1991 Eurocode 1 – Actions on Structures”,
CEN 2002
- [4] Kukulík, P.;
“Timber Structures 10”,
ČVUT, Praha, 2002
- [5] “Handbook 1 – Basis of structural design”,
Leonardo da Vinci Pilot project CZ/02/B/F/PP-134007, Garston, Watford, UK, 2004

Chapter No. 7 has been prepared by Alois MATERNA and Antonín LOKAJ, Faculty of Civil Engineering, Technical University of Ostrava / Czech Republik.



SERVICEABILITY LIMIT STATES

1 Introduction

When designing timber structures using contemporary standards, besides the importance of satisfying the ultimate limit states conditions, it is also important to satisfy the serviceability limit state criteria. This is in order that a designed structural element may maintain a satisfactory serviceability function and a suitable aspect during its life-cycle. In Eurocode 5 [1], there are two main serviceability conditions that must be satisfied:

- Maximal deflections of timber members should be smaller than the prescribed ultimate values deemed to be acceptable,
- Vibrations of timber members should be within a specific range in order to avoid any unacceptable discomfort to the users.

2 Deflections of beams

Serviceability limit states (SLS) for deflection require that the maximal initial ($t = 0$) and final deflection ($t = \infty$) must be calculated within a specified range presented in Tab. 8.2.

2.1 Instantaneous deflections

As we know from classical beam theory, elastic instantaneous deflections ($w_{inst,0}$) are analytically calculated as a sum of a bending ($w_{inst,M}$) force, shear force ($w_{inst,V}$) and axial force ($w_{inst,N}$) part using the formula:

$$w_{inst,0} = \int_S \frac{M_{yd}(x) \cdot M_{y1}(x)}{EI_y} \cdot dx + \int_S \frac{V_{zd}(x) \cdot V_{z1}(x)}{GA_s} \cdot dx + \int_S \frac{N_{xd}(x) \cdot N_{x1}(x)}{EA} \cdot dx \quad (8.1)$$



where:

$M_{y,d}(x)$ is the design bending moment function;

$V_{z,d}(x)$ is the design shear force function;

$N_{x,d}(x)$ is the design axial force function;

EI_y is the bending stiffness;

GA_s is the shear stiffness;

EA is the axial stiffness.

Because of a very low G/E relationship (approx. 1/16), the second term in Eq. (8.1) in timber structures cannot be neglected, as is the usual case with concrete or steel structures.

The design values of actions $S_d = \{M_{y,d}, V_{z,d}, N_{x,d}\}$ are calculated according to Eurocode [2] serviceability limit state loading combinations, due to the dead load ($G_{k,j}$) and the variable load ($Q_{k,i}$) forces:

– Characteristic combination of forces:

$$S = \sum_{j \geq 1} G_{k,j} + Q_{k1} + \sum_{i \geq 2} \Psi_{0i} \cdot Q_{ki} \quad (8.2)$$

– Frequent combination of forces:

$$S = \sum_{j \geq 1} G_{k,j} + \Psi_{11} \cdot Q_{k1} + \sum_{i \geq 2} \Psi_{2i} \cdot Q_{ki} \quad (8.3)$$

– Quasi-permanent combination of forces:

$$S = \sum_{j \geq 1} G_{k,j} + \sum_{i \geq 2} \Psi_{2i} \cdot Q_{ki} \quad (8.4)$$

The internal forces of the variable load actions for buildings are reduced with the $\psi_{0,i}$, $\psi_{1,i}$ and $\psi_{2,i}$ coefficients shown in Tab. 8.1, below:

	ψ_0	ψ_1	ψ_2
1. Live load in buildings			
Category A: residential buildings	0.7	0.5	0.3
Category B: offices	0.7	0.5	0.3
Category C: buildings for meeting-places	0.7	0.7	0.6
Category D: trades	0.7	0.7	0.6
Category E: warehouses	1.0	0.9	0.8
2. Traffic loads			
Category F: vehicle areas; weight up to 30 kN	0.7	0.7	0.6
Category G: vehicle areas; weight between 30 kN and 160 kN	0.7	0.5	0.3
Category H: roofs	0	0	0
3. Climate loads			
Snow load (Finland, Island, Norway, Sweden)	0.7	0.5	0.2
Snow load (CEN members with H ≥ 1000 m ah)	0.7	0.5	0.2
Snow load (CEN members with H < 1000 m ah)	0.5	0.2	0
Wind forces	0.6	0.2	0
Thermal forces	0.6	0.5	0

Fig. 8.1 Values of reduction coefficients $\psi_{0,i}$, $\psi_{1,i}$ in $\psi_{2,i}$ for buildings; Eurocode 0 [2]

Since the presented values are in a sequence $\psi_{0,i} \geq \psi_{1,i} \geq \psi_{2,i}$, the maximal internal forces apply by the characteristic combination of forces, which can be simplified in a form of:

$$S_d \approx \sum_{j \geq 1} G_{kj} + 0.9 \cdot \sum_{i \geq 1} Q_{ki} \tag{8.5}$$

The main distinction in the calculation of the timber structures deflection, when compared to steel or concrete structures deflection, is that an additional deformability of the elements has to be considered. Mechanical fasteners in timber are not as rigid as they are in concrete or steel, but they are flexible.

Consequently, it is in timber structures practically impossible to assure a completely rigid beam-column bending connection. Therefore, additionally deflection ($w_{inst,1}$) should to be expected and considered. The total instantaneous deflection (w_{inst}) can now be formulated as:

$$w_{inst} = w_{inst,0} + w_{inst,1} \quad (8.6)$$

The deflection $w_{inst,0}$ thus represents the deflection if the flexibility of the fasteners is not considered, and the second term ($w_{inst,1}$) represents the deflection due the fasteners flexibility in all joints. Consequently, the second term increases with the number of member connections in a structure and, therefore, it is especially important to consider it with timber trusses, where the value of $w_{inst,1}$ can achieve up to 50% of $w_{inst,0}$ (see e.g. Steck [3] or Šilih et. al. [4]). For example, in timber trusses, where the intermediate members are flexibly connected, their stiffness decreases. In finite element analysis, we can consider the joint flexibility in such a way that cross-section areas A_m of all intermediate members are replaced by a fictiously decreased cross-section area A_m^* :

$$A_m^* = \frac{A_m}{1 + \frac{E_{m,mean} \cdot A_m}{L_m} \cdot \left(\frac{1}{K_{ser} \cdot k_{m,1}} + \frac{1}{K_{ser} \cdot k_{m,2}} \right)} \quad (8.7)$$

where $k_{m,1}$ and $k_{m,2}$ are the numbers of fasteners at both ends of the considered m -th element, and K_{ser} denotes the fasteners' slip modulus, taken for different types of fasteners from Eurocode 5 [1].

The total instantaneous deflection defined in Eq.(8.6) should not exceed the range of limiting values for beam deflections, depending upon the level of deformation deemed to be acceptable. The limiting value of the instantaneous deflection for the simply supported beam is recommended in Eurocode 5 [1] in a range from L/300 to L/500, and it is doubled for cantilevering beams (see Tab. 8.2).

	w_{inst}	$w_{net,fin}$	w_{fin}
Beam on two supports	L/300 to L/500	L/250 to L/350	L/150 to L/300
Cantilevering beams	L/150 to L/250	L/125 to L/175	L/75 to L/150

Fig. 8.2 Examples of limiting values for deflections of beams

2.2 Final deflections

Under a load acting on a structural member for a quite long period of time, the modulus of elasticity (E) decreases, as schematically presented in Fig. 8.1, below:

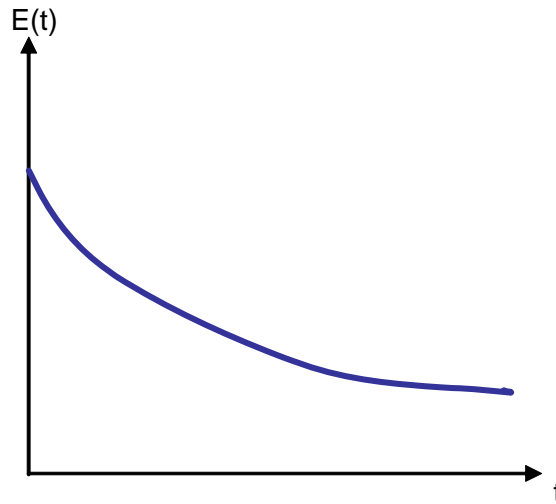

Fig. 8.1 Schematically presentation of a creep function

Because of the presented decreasing of the Young's modulus (E), an additional deformation, called a creep deformation (w_{creep}), appears and the final deflection (w_{fin}) at time $t = \infty$ is thus a sum of the instantaneous (w_{inst}) and the creep deformation, as schematically presented in Fig. 8.2:

$$w_{fin} = w_{inst} + w_{creep} \tag{8.8}$$

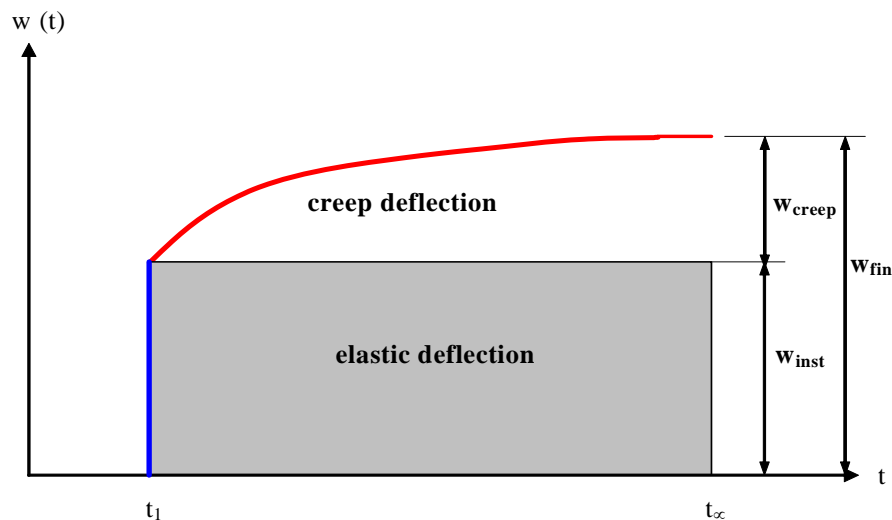

Fig. 8.2 Schematically presentation of final deflections

It is not easy to analytically define a creep function, as presented in Fig. 1 of Eurocode 5 [1] defines an influence of several loads by Boltzmann criteria, where the creep influence of all

loads are approximated with the same function, but with different time periods. A schematic presentation with three different loads is shown in Fig. 8.3.

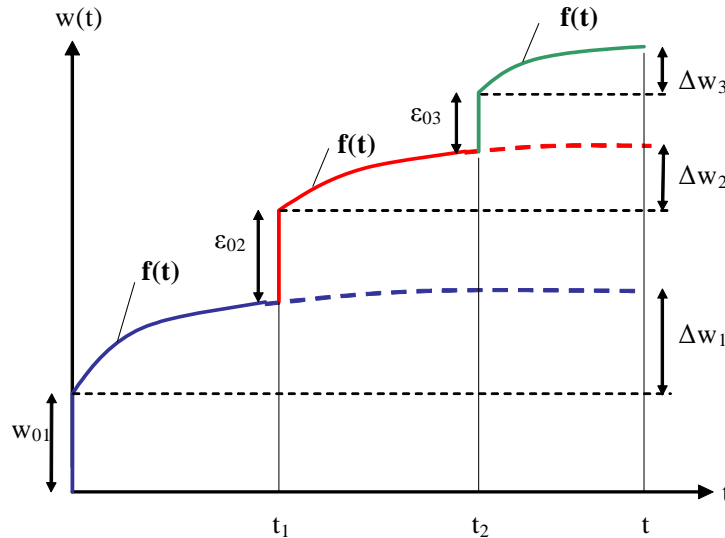

Fig. 8.3 Boltzmann superposition criteria

Consequently, the creep influence of several loads can be written with the same approximation coefficient (k_{def}), which values depends on the serviceability timber classes (S1, S2, S3) and a moisture content. Time duration of loads is approximated with the Ψ_2 coefficient from Table 8.1. Thus Eq. (8.8) is expressed thus:

$$w_{fin} = w_{inst} + w_{creep} = w_{inst} \cdot (1 + \Psi_2 \cdot k_{def}) \quad (8.9)$$

On the other hand, if using the precamber (w_0), the net deflection below a straight line between the supports ($w_{net,fin}$), should be taken as (see Fig. 8.4):

$$w_{net,fin} = w_{inst} + w_{creep} - w_0 = w_{inst} \cdot (1 + \Psi_2 \cdot k_{def}) - w_0 \quad (8.10)$$

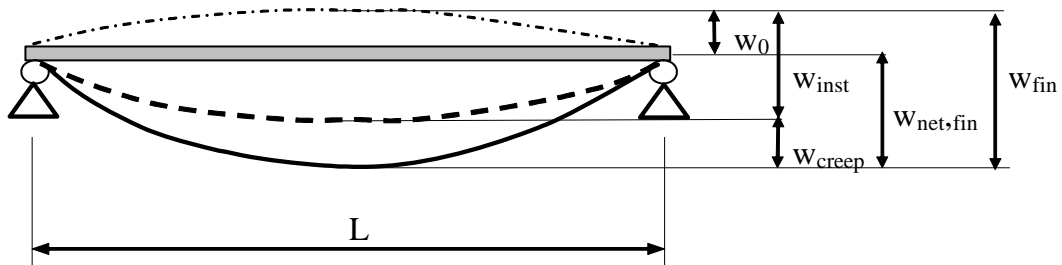

Fig. 8.4 Components of deflections

Therefore, the following serviceability limit state conditions should to be satisfied:



$$\begin{aligned}
 1. \quad & w_{inst} \leq w_{inst,lim} \\
 2. \quad & w_{fin} \leq w_{fin,lim} \\
 3. \quad & w_{net,fin} \leq w_{net,fin,lim}
 \end{aligned}
 \tag{8.11}$$

The prescribed limit values from Eurocode 5 [1] are listed in Tab. 8.2.

3 Vibrations

Eurocode 5 [1] describes that vibrations caused by rotating machinery and other operational equipment shall be limited for the unfavourable combinations of permanent load and variable loads that can be expected. For residential floors with a fundamental frequency greater than 8 Hz ($f_1 > 8$ Hz), the following requirements should be satisfied:

$$1. \quad \frac{w}{F} \leq a \quad [mm/kN] \tag{8.12a}$$

and

$$2. \quad v \leq b^{(f_1 \zeta - 1)} \quad [m/(Ns^2)] \tag{8.12b}$$

where:

w is the maximum instantaneous vertical deflection caused by a vertical concentrated static force F applied at any point on the floor, taking account of load distribution;

v is the unit impulse velocity response, i.e. the maximum initial value of the vertical floor vibration velocity (in m/s) caused by an ideal unit impulse (1 Ns) applied at the point of the floor giving maximum response. Components above 40 Hz may be disregarded;

ζ is the modal damping ratio.

The recommended range of limiting values of a and b and the recommended relationship between a and b is given in Fig. 8.5. For a rectangular floor with overall dimensions $l \times b$, simply supported along all four edges and with timber beams having a span l , the fundamental frequency f_1 may approximately be calculated as

$$f_1 = \frac{\pi}{2\ell^2} \sqrt{\frac{(EI)_\ell}{m}} \tag{8.13}$$

where:



m is the mass per unit area in kg/m²;

l is the floor span, in m;

$(EI)_l$ is the equivalent plate bending stiffness of the floor about an axis perpendicular to the beam direction, in Nm²/m.

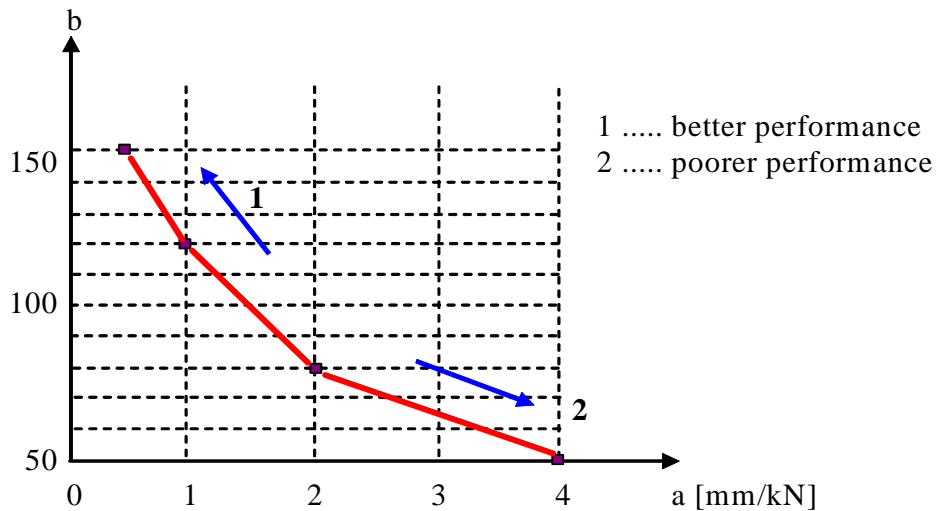

Fig. 8.5 Recommended range of and relationship between a and b

For a rectangular floor with overall dimensions $b \times l$, simply supported along all four edges, the value v may, as an approximation, be taken as:

$$v = \frac{4(0,4 + 0,6 n_{40})}{mb\ell + 200} \quad (8.14)$$

where:

v is the unit impulse velocity response, in m/(Ns²);

n_{40} is the number of first-order modes with natural frequencies up to 40 Hz;

b is the floor width, in m;

m is the mass, in kg/m².



The value of n_{40} may be calculated from:

$$n_{40} = \left\{ \left(\left(\frac{40}{f_1} \right)^2 - 1 \right) \left(\frac{b}{\ell} \right)^4 \frac{(EI)_\ell}{(EI)_b} \right\}^{0,25} \quad (8.15)$$

where:

$(EI)_b$ is the equivalent plate bending stiffness, in Nm^2/m , of the floor about an axis parallel to the beams, where $(EI)_b < (EI)_\ell$.

4 References

- [1] CEN/TC 250/SC5 N173,
"EN 1995-1-1:2004, Eurocode 5: Design of Timber Structures, Part 1-1: General rules and rules for buildings";
Brussels, 2004
- [2] CEN/TC 250,
"EN 1990:2002 E, Eurocode: Basis of structural design",
Brussels 2002
- [3] Steck, G.;
"Fachwerkbinder aus Brettschichtholz und Vollholz",
from "STEP 2 – Holzbauwerke: Bauteile, Konstruktionen, Details nach Eurocode 5",
Düsseldorf: Fachverlag Holz; 1995 (in German)
- [4] Šilih, S., Premrov, M., Kravanja, S.;
"Optimum Design of Plane Timber Trusses Considering Joint Flexibility",
Engineering Structures 27(1), pp.; 2005

Chapter No. 8 has been prepared by Miroslav PREMROV, Faculty of Civil Engineering, University of Maribor / Slovenia.



Chapter No. 9

ULTIMATE LIMIT STATE – STRUCTURAL MEMBERS

1 Introduction

The aim of this chapter is to explain the assessment of timber members that are exposed to basic stresses (tension, compression, shear, bending, and torsion) and their combinations.

2 General

Most timber structures are analysed using elastic structural analysis techniques in ultimate and serviceability limit states. Timber structural members in ultimate limit state are exposed to extreme loading conditions and their models of failure must represent all specific features of solid timber, glued laminated timber or wood-based materials, e.g. influence of temperature, humidity conditions and load-carrying history on strength, etc.

2.1 Ultimate limit state criteria

Designing and the assessment of reliability of timber structural members in ultimate limit state according to contemporary European standards (Eurocode 5) means that each member has to satisfied the main condition in the expression:

$$S_d \leq R_d \quad (9.1)$$

where R_d represents the design value of resistance of the timber structural member (load-carrying capacity) and S_d represents the design value of load-effect combinations.

The design value (f_d) of strength of the timber structural member shall be expressed as:

$$f_d = \frac{k_{mod} \cdot f_k}{\gamma_M} \quad (9.2)$$

where f_k represents a characteristic value of a strength property (according to standards), k_{mod} is a modification factor taking into account the effect of the duration of load and moisture content, and γ_M is the partial factor for material property.

Load actions can be expressed by combinations according to characteristic load combination situations.

- For a persistent and transient design situation:

$$\sum_{j \geq 1} \gamma_{G,j} G_{k,j} \oplus \gamma_P P \oplus \gamma_{Q,1} Q_{k,1} \oplus \sum_{i > 1} \gamma_{Q,i} \psi_{0,i} Q_{k,i} \quad (9.3)$$

- For an accidental design situation:

$$\sum_{j \geq 1} G_{k,j} \oplus P_K \oplus A_d \oplus (\psi_{1,1} \text{ or } \psi_{2,1}) Q_{k,1} \oplus \sum_{i > 1} \psi_{2,i} Q_{k,i} \quad (9.4)$$

- For a seismic design situation:

$$\sum_{j \geq 1} G_{k,j} \oplus P_K \oplus A_{Ed} \oplus \sum_{i > 1} \psi_{2,i} Q_{k,i} \quad (9.5)$$

where G are permanent actions, P is prestress, Q are variable actions (Q_1 is the leading variable action, Q_i are other variable actions), A is an accidental or seismic force, γ are partial factors, and ψ are combination factors.

3 Design of cross-sections subjected to stress in one principal direction

The timber member consisting of constant cross-section, whose grain runs essentially parallel to the length of the member, is assumed to be subjected to stresses in the direction of only one of its principal axes (Fig. 9.1).

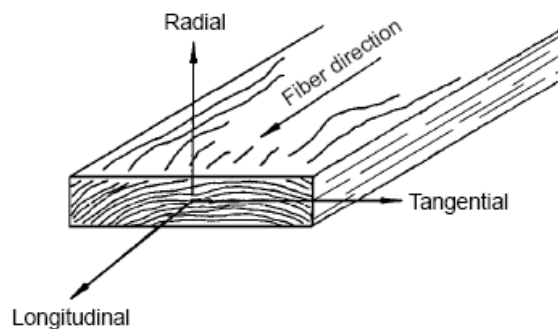

Fig. 9.1 Solid timber member axes

Solid timber exhibits different behaviour under stress in comparison to steel or concrete (Fig. 9.2).

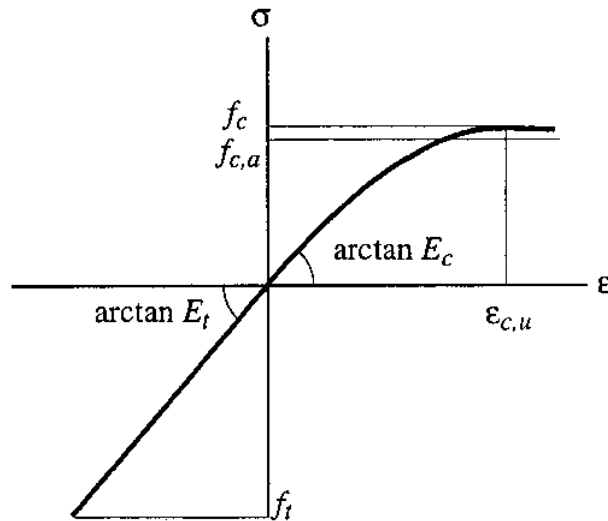

Fig. 9.2 Solid timber: stress - strain diagram (Glos, 1978)

3.1 Timber members exposed to tension

3.1.1 Tension parallel to the grain

Clear wood exhibits its highest strength for tension parallel to the grain (over 100 N/mm²). However, due to the existence of natural inhomogeneous conditions and deviations in structural timber and wood-based materials (e.g. knots, fissures, fibre angle etc.), which are often called defects, the tension strength parallel to the grain may drop to less than 10 N/mm² for structural timber of low quality.

The tension parallel to the grain is also influenced by the size of the member. In Eurocode 5, the characteristic strength values of solid timber are related to a width in tension parallel to the grain of 150 mm and 600 mm for glued laminated timber. For widths of solid timber less than 150 mm and 600 mm for glued laminated timber, the characteristic values in tension may be increased by a special factor k_f .

The basic formula for tensile strength parallel to the grain assessment is:

$$\sigma_{t,0,d} \leq f_{t,0,d} \tag{9.6}$$

where

$\sigma_{t,0,d}$ is the design tensile stress along the grain;

$f_{t,0,d}$ is the design tensile strength along the grain.

3.1.2 Tension perpendicular to the grain

Tension perpendicular to the grain is the lowest strength for timber. In timber members, tensile stresses perpendicular to the grain should be avoided or kept as low as possible. The effect of the member size must be taken into account.



The basic formula for tensile strength perpendicular to the grain assessment is:

$$\sigma_{t,0,d} \leq f_{t,0,d} \quad (9.7)$$

where

$k_{vol} = 1$ for solid timber;

$k_{vol} = \left(\frac{V_0}{V}\right)^{0.2}$ for glued laminated timber and LVL with all veneers parallel to the beam axis;

V_0 is the reference volume of 0.01 m³;

V is the stressed volume in m³;

$\sigma_{t,90,d}$ is the design tensile stress perpendicular to the grain;

$f_{t,90,d}$ is the design tensile strength perpendicular to the grain.

3.2 Timber members exposed to compression

At the ultimate limit state, the compression member will have achieved its compressive capacity whether limited by material crushing or buckling (Fig. 9.3). In contrast to the brittle, explosive failure of tension members, the compression failure is quiet and gradual. Buckling is quite silent as it is not associated with material failure at all, and crushing is accompanied by a “crunching or crackling” sound. However, in spite of the silence of failure, any structural failure can lead to a loss, or at least a partial loss, of the structural system and place a risk on human life. Both modes of failure are just as serious as the more dramatic tensile and bending failures.

3.2.1 Compression parallel to the grain

The strength in compression parallel to the grain will be somewhat reduced by the growth defects to $f_{c,0} = 25$ to 40 N/mm^2 . When the short timber member without stability problems is compressed parallel to the grain, local damage of fibres under specific angles ($50^\circ - 65^\circ$) will occur (Fig. 9.3).

The basic formula for assessment of compression strength parallel to the grain is:

$$\sigma_{c,0,d} \leq f_{c,0,d} \tag{9.8}$$

where

$\sigma_{c,0,d}$ is the design compression stress along the grain;

$f_{c,0,d}$ is the design compression strength along the grain.

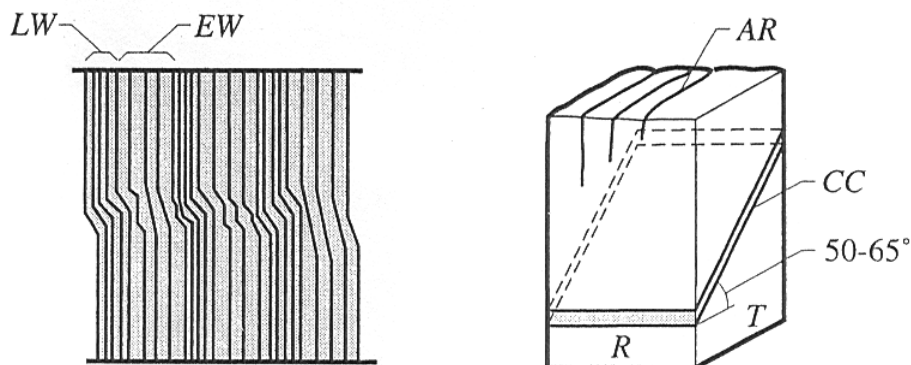

Fig. 9.3 Failure mechanism of timber member in compression

3.2.2 Compression perpendicular to the grain

The bearing capacity of timber members exposed to compression perpendicular to the grain is a function of the crushing strength of the wood fibre. When the bearing capacity is exceeded, local crushing and significant deformations occur (Fig. 9.4). The influence of growth defects on the strength perpendicular to the grain is small.

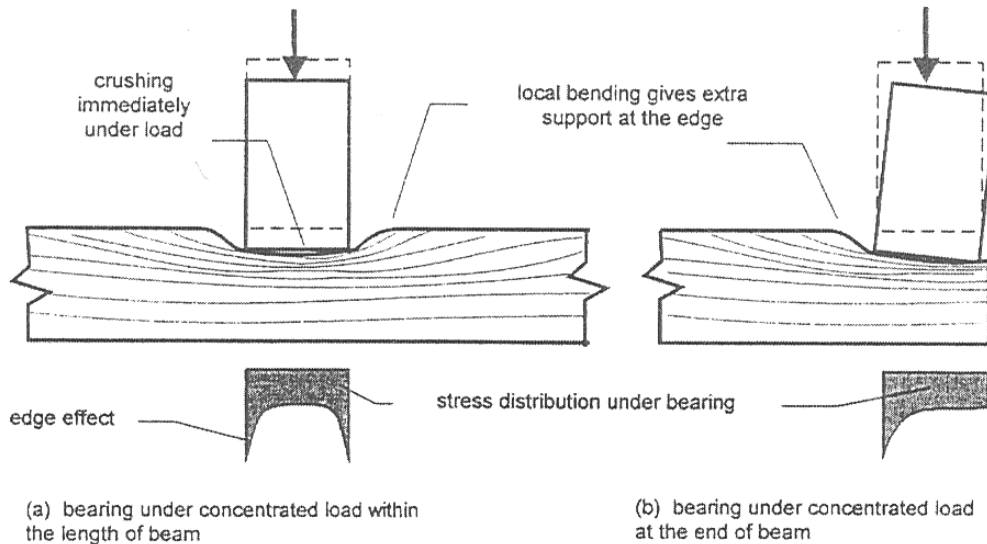

Fig. 9.4 Bearing effects at supports and points of concentrated load application

The basic formula for assessment of compression strength perpendicular to the grain is:

$$\sigma_{c,90,d} \leq k_{c,90} f_{c,90,d} \quad (9.9)$$

where:

$\sigma_{c,90,d}$ is the design compression stress perpendicular to the grain;

$f_{c,90,d}$ is the design compression strength perpendicular to the grain;

$k_{c,90}$ is a factor taking account of the load configuration, possibility of splitting and the degree of compressive deformation.

3.3 Timber members exposed to bending

Members predominantly subjected to bending are beams (solid timber members in bending tests (Fig. 9.5)). Beams, in general, are horizontal structural elements which span at least two supports and transmit loads principally by bending action. The bending moments on the beam are due to loads which act in the plane of the bending of the beam.



Fig. 9.5 Solid timber bending test

For beams which are subjected to bi-axial bending, the following two conditions need to be satisfied:

$$\frac{\sigma_{m,y,d}}{f_{m,y,d}} + k_m \frac{\sigma_{m,z,d}}{f_{m,z,d}} \leq 1 \quad (9.10)$$

$$k_m \frac{\sigma_{m,y,d}}{f_{m,y,d}} + \frac{\sigma_{m,z,d}}{f_{m,z,d}} \leq 1 \quad (9.11)$$

where:

$\sigma_{m,y,d}$ and $\sigma_{m,z,d}$ are the design bending stresses about the principal axes;

$f_{m,y,d}$ and $f_{m,z,d}$ are the corresponding design bending strengths;

k_m is the factor which makes allowance for re-distribution of stresses and the effect of inhomogenities of the material in cross-sections. The value of the factor k_m should be taken as follows:

For solid timber, GLT, LVL: $k_m = 0.7$ (for rectangular cross-sections)

$k_m = 1.0$ (for other cross-sections)

For other wood-based materials and for all cross-sections: $k_m = 1.0$.



3.4 Timber members exposed to shear

When a timber beam is exposed to transverse loading, shear stresses will occur according to the theory of elasticity. Shear stresses transverse to the beam axis are accompanied by equal shear stresses parallel to the beam axis.

The basic formula for the assessment of the shear strength is:

$$\tau_{v,d} \leq f_{v,d} \quad (9.12)$$

where:

$\tau_{v,d}$ is the design shear stress;

$f_{v,d}$ is the design shear strength.

For rectangular cross-sections, the maximum value of design shear stress is:

$$\tau_{v,d} = \frac{3 V_d}{2 A} \quad (9.13)$$

For circular cross-sections, the maximum value of design shear stress is:

$$\tau_{v,d} = \frac{4 V_d}{3 A} \quad (9.14)$$

where A is the area of the cross-section and V_d is the maximum shear force.



3.5 Timber members exposed to torsion

Torsional stress occurs at members that are exposed to the loads eccentric to the main axes and twisting with these members occur. According to commonly accepted elastic theory, the maximum torsional stress for solid members can be expressed as:

$$\tau_{tor} \leq k_{shape} f_{v,d} \quad (9.15)$$

with

$$k_{shape} = 1.2 \quad \text{for a circular cross section}$$

$$k_{shape} = \min \left\{ \begin{array}{l} 1 + 0.15 \frac{h}{b} \\ 2.0 \end{array} \right\} \quad \text{for a rectangular cross section;}$$

$\tau_{tor,d}$ is the design torsional stress;

$f_{v,d}$ is the design shear strength;

k_{shape} is a factor depending on the shape of the cross-section;

h is the larger cross-sectional dimension;

b is the smaller cross-sectional dimension.

For circular cross-sections, the maximum value of torsional stress is:

$$\tau_{tor} \leq \frac{2 M_T}{\pi r^3} \quad (9.16)$$

where r is the radius of the cross-section.

For square/rectangular cross-sections, the maximum value of torsional stress is:

$$\tau_{tor} \leq \frac{M_T}{\alpha h b^2} \quad (9.17)$$

where:

M_T is maximum value of the torsion moment;

h is height of the cross-section;

b is width of the cross-section;

α is the factor depending on the ratio h/b (according to Timoshenko).

4 Design of cross-sections subjected to combined stresses

4.1 Compression stresses at an angle to the grain

These types of stresses mainly occur at carpentry joints (Fig. 9.6).



Fig. 9.6 Carpentry joints

The compression stresses at an angle to the grain should satisfy the following expression (Hankinson's formula (Fig. 9.7)):

$$\sigma_{c,\alpha,d} \leq \frac{f_{c,0,d}}{\frac{f_{c,0,d}}{k_{c,90} f_{c,90,d}} \sin^2 \alpha + \cos^2 \alpha} \quad (9.18)$$

where:

$\sigma_{c,\alpha,d}$ is the compressive stress at an angle α to the grain;

$k_{c,90}$ is a factor taking account the effect of any of stresses.

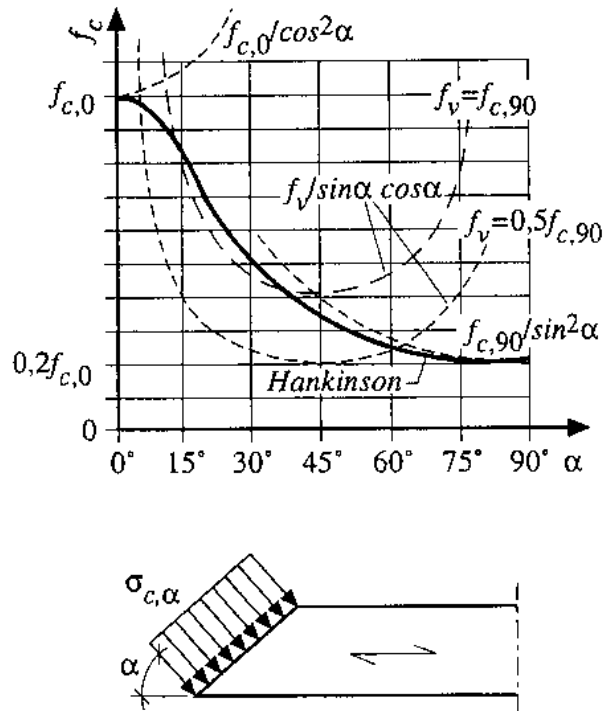

Fig. 9.7 Timber compression strength at an angle to the grain

4.2 Combined bending and axial tension

The following expressions shall be satisfied:

$$\frac{\sigma_{t,0,d}}{f_{t,0,d}} + \frac{\sigma_{m,y,d}}{f_{m,y,d}} + k_m \frac{\sigma_{m,z,d}}{f_{m,z,d}} \leq 1 \quad (9.19)$$

$$\frac{\sigma_{t,0,d}}{f_{t,0,d}} + k_m \frac{\sigma_{m,y,d}}{f_{m,y,d}} + \frac{\sigma_{m,z,d}}{f_{m,z,d}} \leq 1 \quad (9.20)$$

4.3 Combined bending and axial compression

The following expressions shall be satisfied:

$$\left(\frac{\sigma_{c,0,d}}{f_{c,0,d}} \right)^2 + \frac{\sigma_{m,y,d}}{f_{m,y,d}} + k_m \frac{\sigma_{m,z,d}}{f_{m,z,d}} \leq 1 \quad (9.21)$$

$$\left(\frac{\sigma_{c,0,d}}{f_{c,0,d}} \right)^2 + k_m \frac{\sigma_{m,y,d}}{f_{m,y,d}} + \frac{\sigma_{m,z,d}}{f_{m,z,d}} \leq 1 \quad (9.22)$$

4.4 Stability of members

4.4.1 Column buckling in compression

Axially loaded slender columns have a tendency to sideways deflection in the direction of maximal slenderness (Fig. 9.8). This type of instability is called flexural buckling. Therefore, load-bearing capacity of slender columns depends either on their compression and bending strengths or on their modulus of elasticity. The load-bearing capacity of slender members depends on many various factors, which can be divided in two groups.

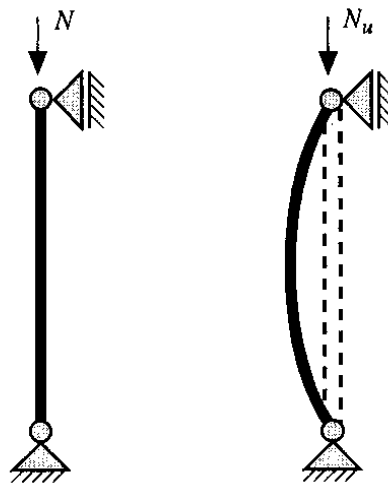

Fig. 9.8 Scheme of axially loaded column deflection

The first group involves the nominal geometry of the compression member such as its cross-section and length, its support conditions and the material properties, which are determined by the choice of the strength class, the surrounding climate and the load duration class of the governing load case. These factors are either determined by, or known to, the designer and they are able to influence the load-bearing capacity of the member by adjusting these factors.

The second group of factors influencing load-bearing capacity of slender columns involves geometric and material variations and imperfections. No one structure is perfect, so that these factors have to be considered during the design of the column. Designers have not enough information about these factors, so that their influence has to be taken into account implicitly during the design with the use of standards (e.g. EC5). The most important geometric imperfections of timber compression columns are the initial curvature, inclination of the member axis and deviations of cross-sectional dimensions from the nominal values. Material imperfections include growth characteristics and other factors, which influence the stress-strain behaviour of timber (Fig. 9.2). Generally, the stress-strain curve is linear elastic until failure for timber exposed to tensile stresses, and non-linear with considerable plastic deformations under compression stresses. The shape of the stress-strain curve of European softwood depends mainly on density, knot size, content of compression wood and moisture content.

There are two principal ways of designing a compression slender column. The first involves a second order analysis whereby the equilibrium of moments and forces is calculated by considering the deformed shape of the member. The second approach is based on using buckling curves to account for the decrease in strength of a real column compared to a compression member that is infinitely stiff in bending. The stability design is carried out as a compression design with a modified compression strength.

According to Eurocode 5, the buckling curves generally describe the influence of slenderness on the characteristic load-bearing capacity of two-hinged columns. Each value on a buckling curve consequently represents the characteristic load-bearing capacity of columns with the corresponding slenderness ratio λ (Fig. 9.9). The slenderness ratio λ is defined as the largest ratio of the unbraced length (buckling length) to the radius of gyration.

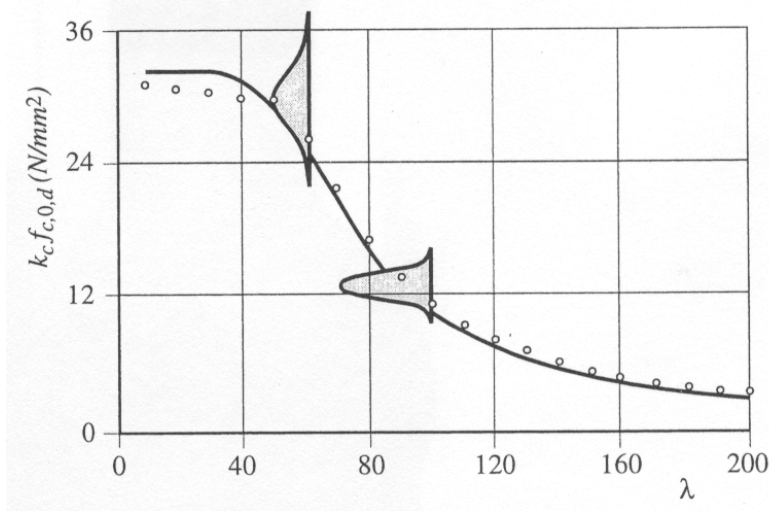

Fig. 9.9 Buckling curve according EC5

The effective or buckling length of a compression member is defined as the length of a hypothetical two-hinged column with the same elastic critical buckling load as the member in question. The buckling length can be visualised as the distance between two consecutive points of contraflexure of the actual compression member. Figure 9.10 shows the four Euler's cases where the buckling length is given for different support conditions of the ideal straight column.

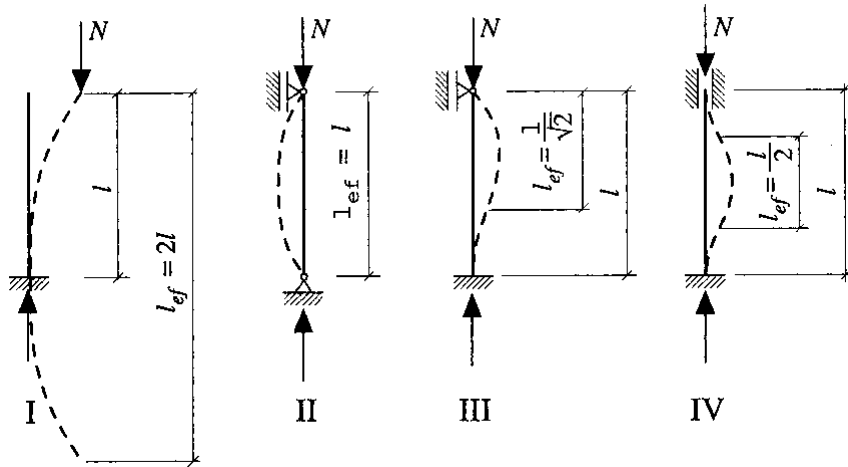

Fig. 9.10 Buckling lengths for various support conditions of an ideal column (Euler cases I to IV)

The basic formula for the assessment of an axially compressed slender column is:

$$\sigma_{c,0,d} \leq k_c f_{c,0,d} \tag{9.23}$$

where:

$\sigma_{c,0,d}$ is the design compression stress parallel to the grain;

$f_{c,0,d}$ is the design compression strength parallel to the grain;

k_c is a factor, which takes into account the reduced compression strength parallel to the grain due to buckling.

$$k_c = \frac{1}{k + \sqrt{k^2 - \lambda_{rel}^2}} \tag{9.24}$$

$$k = 0.5 [1 + \beta_c (\lambda_{rel} - 0.3) + \lambda_{rel}^2] \tag{9.25}$$

where:

β_c is a factor for members within the straightness limits ($\beta_c = 0.2$ for solid timber, $\beta_c = 0.1$ for glued laminated timber and LVL).

The relative slenderness ratio is defined by:

$$\lambda_{rel} = \sqrt{\frac{f_{c,0,k}}{\sigma_{c,crit}}} \quad (9.26)$$

where:

$$\sigma_{c,crit} = \pi^2 \frac{E_{0,05}}{\lambda^2} \quad (9.27)$$

with the slenderness ratio: $\lambda = \frac{L_{cr}}{i}$.

4.4.2 Lateral-torsional buckling of beams

When designing beams, the prime concern is to provide an adequate load carrying capacity and stiffness against bending about its major principal axis, usually in the vertical plane. This leads to a cross-sectional shape in which the stiffness in the vertical plane is often much greater than that in the horizontal plane. Figure 9.11 illustrates the response of a slender simply supported beam, exposed to bending moments in the vertical plane. Both lateral deflection and twisting of the beam is termed lateral-torsional buckling. This type of instability is similar to the simpler flexural buckling of axially loaded columns in that loading the beam in its stiffer vertical plane has induced a failure by buckling in a less stiff direction.

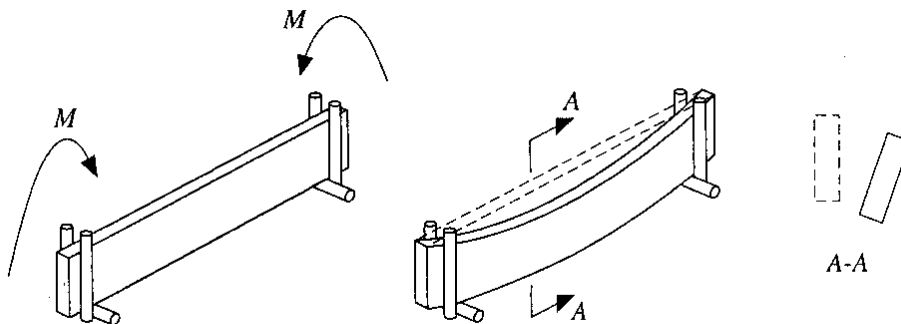

Fig. 9.11 Lateral-torsional buckling of a simply supported beam



The basic formula for the assessment of the simply supported beam with lateral-torsional buckling (instability) according EC5 is:

$$\sigma_{m,d} \leq k_{crit} f_{m,d} \quad (9.28)$$

where:

$\sigma_{m,d}$ is the design bending stress;

$f_{m,d}$ is the design bending strength;

k_{crit} is a factor, which takes into account the reduced bending strength due to lateral-torsional buckling. Factor k_{crit} is function of the relative slenderness ratio for bending $\lambda_{rel,m}$:

$$k_{crit} = 1 \quad \text{for } \lambda_{rel,m} \leq 0.75$$

$$k_{crit} = 1.56 - 0.75\lambda_{rel,m} \quad \text{for } 0.75 < \lambda_{rel,m} \leq 1.4$$

$$k_{crit} = \frac{1}{\lambda_{rel}^2} \quad \text{for } 1.4 < \lambda_{rel,m}$$

$$\lambda_{rel,m} = \sqrt{\frac{f_{m,k}}{\sigma_{m,crit}}} \quad (9.29)$$

The critical bending stress:

$$\sigma_{m,crit} = \frac{M_{y,crit}}{W_y} = \frac{\pi \sqrt{E_{0,05} I_z G_{0,05} I_{tor}}}{l_{ef} W_y} \quad (9.30)$$

5 Conclusions

Solid timber and wood based materials are materials with natural origins that involve many various inhomogenities, imperfections and defects, which influence physical and mechanical properties in combination with loading history and environmental conditions. All these factors demand a specific approach to timber members' design and assessment, as opposed to other building materials.



6 References

- [1] Blass, H. J. et. al.;
"STEP 1 – Timber Engineering",
Centrum Hout, The Netherlands, 1995
- [2] Kuklíc, P.;
"Timber Structures 10",
CTU Prague, ISBN 80-01-02639-6, 2002
- [3] Forest Products Laboratory;
"Wood handbook – Wood as an engineering material",
Gen. Tech. Rep. FPL-GTR-113. Madison, WI, U.S. Department of Agriculture, Forest
Service, Forest Products Laboratory, 463 p., 1999

Chapter No. 9 has been prepared by Alois MATERNA and Antonín LOKAJ, Faculty of Civil Engineering, Technical University of Ostrava / Czech Republic.



ULTIMATE LIMIT STATES – JOINTS

1 Introduction

The field of Timber Engineering is, due to natural given restrictions, i.e. bar-like products with limited dimensions in the length and of the cross-section, strongly affected by an efficient and reliable connection technique. In many practical cases, the dimensions of load carrying members are determined by the design of joints and not by the design of the cross-section or stability problems of the member itself. Within the design process in particular, the behaviour of joints with respect to the load-carrying capacity, the stiffness and the ductility have to be considered.

Apart from other technical questions, e.g. the dynamical behaviour or the resistance against the actions of fire, the production of joints is influenced by production and assembling costs. As a consequence, the choice of the most proper fastener technique is a significant aspect for an economical solution and the competitiveness of timber constructions. As few joints as possible should be arranged within a building, whereas the size of the members have to be adjusted to the possibilities of the production, the erection and the transportation of the members to the building site. Despite the fact that different fastener systems can be applied within a building, the same system with as few as possible changes of parameters, e.g. dowel diameter, thickness of steel plates etc., should be used. In general the design of joints has to be conceived as simple and as compact as possible.

Last but not least – in an early stadium of the design process of a building – architects and engineers should be aware that the chosen type of the fasteners system also influences the architectural quality and the aesthetics of a building, respectively.

2 Types of fasteners and joints

The development of fastener systems in timber engineering in many cases has been affected in a random and spontaneous way for specific project requirements. In the course of time many fastener systems and possibilities for the design of joints were generated. In general these systems consider an adaptation of:

- the type of loading (compression, tension, bending, ...),
- the wood species / moisture content,
- the geometric boundary conditions of the joint and size of members to be jointed, and
- the construction sequence (production / assembling).

According to these parameters different classification systems for fasteners and joints are defined in references. The following structure is used within this chapter:

2.1 Carpentry (traditional) joints

In general, forces of load-carrying members are transmitted by contact of the joint-areas in compression and by friction. (Mechanical) Fasteners are only used to ensure a correct fit of the connection or to introduce additional forces. These connections are often manufactured by carpenters' experience and construction-rules, respectively, and seldom designed (calculated) by engineers. Although a lot of forms are known, only a few types of carpentry joints are used today (basic forms are given in Fig. 10.1). For about two decades traditional, joints have been manufactured effectively by using CNC-machines. Because of this, the interest in this type of joints is renewed.

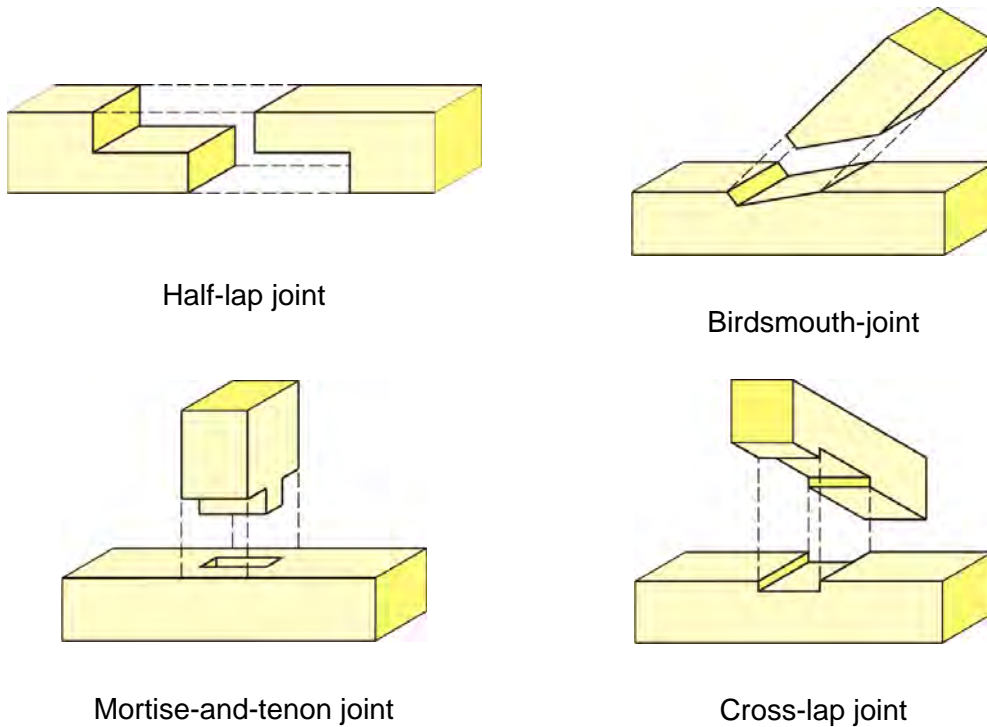

Fig. 10.1 Basic forms of carpentry joints

2.2 (Engineer-) Designed joints

Contrary to carpentry joints, these types of joints are designed (calculated and optimised) by engineers. As a further characteristic, the load-transfer is done by means of mechanical fasteners or adhesives. Depending on how forces are transmitted between the members, designed (or engineered) joints can be divided into four groups:

2.2.1 Pin-like Fastener Systems

Pin-like fastener systems are the most important group of fastener systems in timber engineering. Depending on the load-carrying mechanism, this group can be separated into two subgroups:

- Pin-like fasteners predominantly loaded transversal to their axis

The load-transfer involves the bending behaviour of the pin-like fastener as well as bearing (“embedment stresses”) and shear stresses in timber members along the shank of the fastener. Staples, nails, screws, bolts and dowels, but also glued-in rods loaded transversal to their axis, are part of this group (Fig. 10.2).



Staples (with compressed-air machine)



Nails



Screws



Bolts



Dowels



Glued-in rods
(loaded transversal to their axis)

Fig. 10.2 Pin-like fasteners predominantly loaded transversal to their axis

- Pin-like fasteners predominantly loaded longitudinal to their axis

This group of fasteners transmits forces by means of withdrawal forces. Glued-in rods loaded in their axis and inclined self-tapping (wood-) screws for high capacity joints, but also special nails (helically threaded and annular ringed shank nails) for smaller loads, are typical fasteners of this subgroup (Fig. 10.3).



Self-tapping (wood-) screws

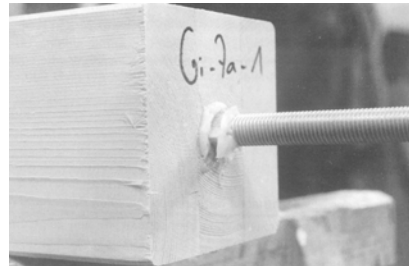

Glued-in rods (loaded longitudinal to their axis)

Fig. 10.3 Pin-like fasteners predominantly loaded longitudinal to their axis

- Combined loaded pin-like fasteners

Some fasteners can be loaded in both directions – transversal and longitudinal to their axis. For design purposes forces are split in both directions and the load-carrying capacity is then specified by an interaction rule of the components.

2.2.2 Surface load-transmitting fasteners

The load transfer is primarily achieved by large bearing areas at the surface of the members to be connected. This group includes split-rings, shear-plates and punched metal plates (Fig. 10.4).



Split-ring



Shear-plate



One and two sided toothed shear plates



Punched metal plates

Fig. 10.4 Surface load-transmitting fasteners

2.2.3 Glued-joints

Members are connected by means of adhesives. For the production a specific quality control is necessary. This type is utilised for finger-joints in the production of glulam and with larger fingers also for the connection of frame corners etc. Another application is the gluing of large areas for the load-transfer in timber-to-timber connections and the width of glulam lamellas.



Fig. 10.5 Finger-joint of a glulam lamella and glued frame corner

A new possibility is the “welding” of timber (at least in laboratory conditions) by using the “natural” adhesive lignin. Because of its similarity to glued-joints this type should be also mentioned here.

2.2.4 Formed (steel) parts and “system-fasteners”

To achieve a quicker assembly, formed (steel) parts for different purposes and configurations are available. Recently also standardised “system-fasteners”, similar to those used for furniture, have been available for different load-carrying connections (Fig. 10.6).



Formed (steel-) parts



“System fasteners”

Fig. 10.6 Formed (steel) parts and “system fasteners”

3 Design of joints

The following section will outline and describe in detail the general aspects for the design of joints, which will be separated into technical and economical tasks for fasteners and joints, respectively.

3.1 Technical aspects

3.1.1 Load-slip-curve of fasteners / joints

In Figure 10.7 a typical load-slip-curve (also load-deformation-curve) explaining the mechanical behaviour of a joint is given. The shown relationship is in general also valid for the mechanical behaviour of fasteners.

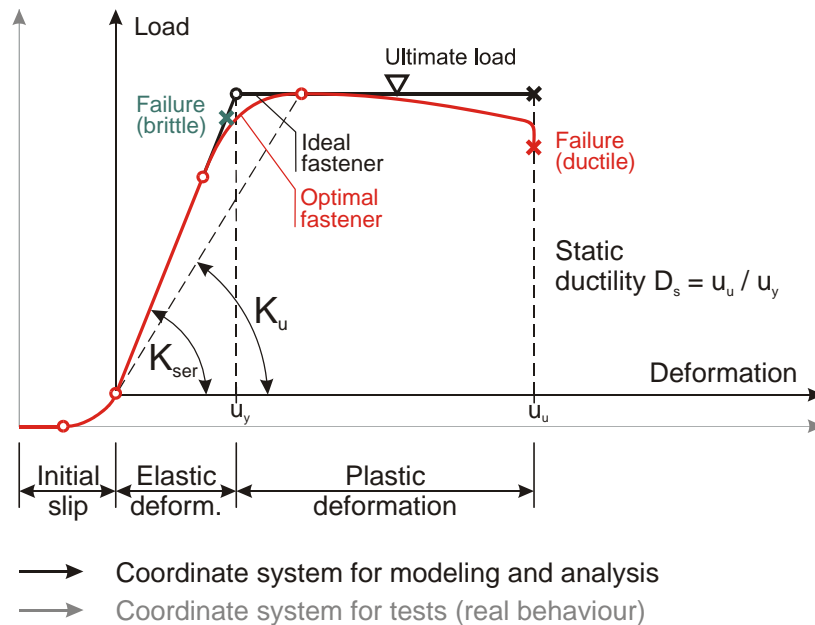

Fig. 10.7 Typical load-slip-curve with definition of important parameters concerning the mechanical behaviour of joints and fasteners respectively

For some fasteners an „initial slip“ can occur; this is the deformation independent of the applied load. If the fastener is loaded, it comes into contact with the borehole until it is pressed continuously against it (“embedded”). When loads are increased further, in general a more or less linear behaviour between load and displacement of the fastener can be found. If the behaviour of the joint is “brittle“, i.e. it has only a small capacity for deformation before it reaches the ultimate load; according to a defined load-level, failure occurs. Contrary to this, “ductile“ (ductility = possibility of plastic deformations) joints are characterised by significant deformations before they reach the ultimate load. Due to different reasons, the ductile failure mode should appear in well designed joints.

Characteristic quantities for the description of the mechanical behaviour of fasteners are, beside the ultimate load, the static ductility D_s (defined as ratio between the slip corresponding to the ultimate load u_u and the slip at the upper limit of the linear elastic area u_y). For the description of stiffness, the slope of the load-slip-curve in the linear-elastic range

(slip modulus K_{ser}) for calculation in serviceability limit states and the secant to the ultimate load of the fastener (slip modulus in the ultimate limit state K_u) are important parameters.

Depending on the type of fastener different mechanical behaviour can be found. Figure 10.8 shows load-slip-curves for some fasteners in tension parallel to grain.

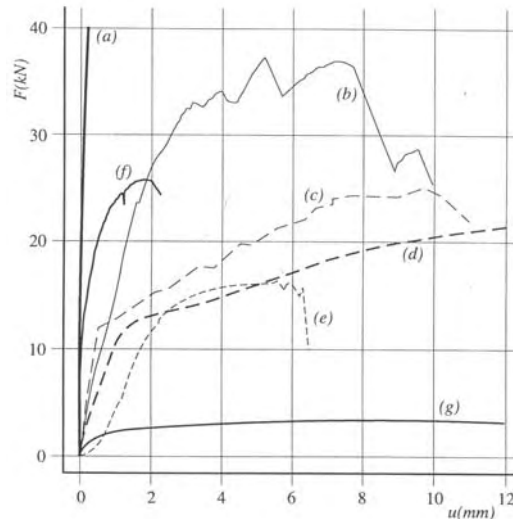

Fig. 10.8 Experimental load-slip-curves for joints in tension parallel to the grain: (a) glued joints, (b) split-ring (100 mm), (c) double sided toothed-plate (62 mm), (d) dowel (14 mm), (e) bolt (14 mm), (f) punched plate (104 mm²), (g) nail (4,4 mm); from [1]

3.1.2 Models for the mechanical behaviour of joints

With the mentioned aspects, the mechanical behaviour in the design of joints can be considered in the structural analysis by means of the following models for different design situations.

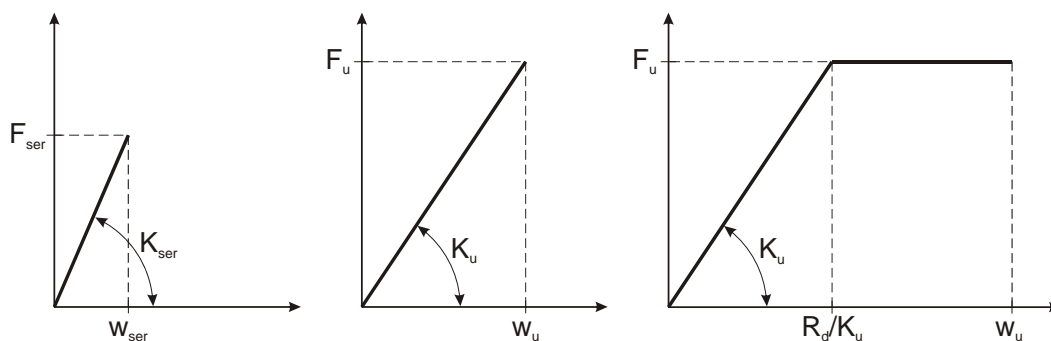

Fig. 10.9 Models for the description of the load-carrying behaviour of fasteners and joints respectively; left: serviceability limit state: elastic model; middle: ultimate limit state – brittle behaviour: elastic model; right: ultimate limit state – ductile behaviour: ideal elastic-ideal plastic model

3.1.3 The most important factors for the design of joints: Load-carrying capacity, stiffness and ductility

From the technical point of view, the following three important requirements should be fulfilled by a joint and, therefore, taken into account during the design process:

- High load-carrying capacity and effectiveness respectively

The load carrying capacity and effectiveness of a joint, respectively, is limited by the strength of the timber members to be jointed and is a function of the “flow of forces” within the connection zone.

The factor of efficiency, η , is given by the relation of the load-carrying capacity of the timber members and the capacity of the joint. In the following table, the effectivity for some typical fastener systems is given:

(Maximum) Factor of effectivity η	Theoretical	Practical
Glued joints		
- Scarf joints	$\approx 1,00$	$\approx 0,90$
- Finger joints	$\approx 0,85$	$\approx 0,80$
Steel-to-timber-connections	$\approx 0,75$	$\approx 0,60$
Timber-to-timber-connections	$\approx 0,60$	$\approx 0,50$

Fig. 10.1 Numbers of effectivity for some typical fastener systems

- High stiffness

In the context of connections technique, stiffness denotes the flexibility of fasteners/joints due to mechanical actions. In general this influences the deformations of timber buildings. As a consequence it has to be considered in the serviceability limit state (SLS). In the case of indeterminated structural systems, members that are relevant to stability problems and buildings that have to be designed using theory of second order, including internal forces, are influenced by the flexibility of the joints. As a consequence for these cases, the stiffness has to be considered also in the ultimate limit state (ULS).

Depending on their stiffness, joints can be categorised into the following types:

- “Very stiff” joints with brittle failure modes ($\eta \approx 1,0$)

For this type, the load-carrying capacities should be aimed as high as possible. For common structural timber and glulam a capacity of the given strength grades of the connected members can be achieved, i.e. the ultimate load is limited by the mechanical properties of the members. A typical example of this group are finger-joints.



- “Stiff” connections ($\eta \approx 0,6 - 0,8$)

A plastic load-carrying behaviour should be aimed for in this type of joint. Examples for this type are split-rings and shear-plates, punched metal plates, glued-in rods, axially loaded (wood-) screws and “compact” dowel and bolt joints.

- “Flexible” connections ($\eta < 0,6$)

This type of connection system tolerates unintentioned movements of supports, etc., but the stiffness behaviour of the whole structure is influenced. Typical fasteners for this group are “slender” dowels and bolts, laterally loaded wood screws and nails.

With the slope of the load-slip curve a so called “slip modulus” per fastener and shear plane can be defined and taken into account in the design process. From the mechanical point of view, fasteners are considered in that way as springs in the structural analysis with the slip modulus of the joint as a parameter.

For the serviceability limit state (SLS), the slip modulus K_{ser} , corresponding to the slope of the load-slip curve in the elastic range, has to be taken into account. For some fastener types values for K_{ser} [N/mm²] (per fastener and shear plane) are defined in EN 1995-1-1.

For design situations (ULS) where joints flexibility is also influencing the internal forces of the structure (e.g. undetermined structural systems etc.), a slip modulus K_u has to be used. Within the European standard framework this modulus is recommended for all fasteners as:

$$K_u = \frac{2}{3} \cdot K_{ser} \quad (10.1)$$

with:

K_{ser} Slip-modulus for serviceability limit state [N/mm²]

K_u Slip-modulus for ultimate limit state [N/mm²]

Depending on the examined configuration, creep and shrinkage have to be considered; that means that calculations of the internal forces have to be done for different time states ($t = 0$ and $t = \infty$).

– High ductility

Timber and engineered wood products as a material are characterised in general by a brittle mechanical behaviour, i.e. only relatively small deformation can be measured before members fail. This behaviour is not desired in the design of buildings. In practise a ductile design of joints is often the only way to get sufficient ductile structures in timber engineering.

For connections a high level of deformability, i.e. a high ratio of ultimate to elastic deformations, is desired. In general, the ductility influences the:

- the load-carrying behaviour of the structure and the joints,
- the load-carrying behaviour of a group of joints.

If the necessary ductility of joints cannot be reached, timber members can split and, as a consequence, the so called “zip-effect” can appear. That means that due to a splitting-failure of one fastener also subsequent fasteners in a row can fail.



Fig. 10.10 Splitting of a test specimen in the embedment zone of a fastener and “zip-effect” in a tested joint

3.1.4 Other technical requirements

– Dynamical behaviour

Apart from the already mentioned requirements, in some cases also the behaviour of fasteners and joints with regard to dynamical and fatigue loading has to be taken into account.

For example, some fasteners (brackets, nails, nail-plates, split-ring and shear plate fasteners) are not appropriate for use in timber bridges under traffic loads.

Special details concerning this topic can be had from specific literature.

– Resistance against the action of fire

It has to be mentioned that fasteners and joints, respectively, can strongly influence the behaviour of structures in the case of fire. In particular, unprotected steel members lead to a decreased resistance to fire of joints and the whole timber structure because of the high temperature conductivity. If necessary, appropriate measures for an increased resistance against fire should be implemented.

Details concerning this topic can be found in Chapter 17 of this handbook and/or in the appropriate references.



3.2 Economical aspects

Apart from technical aspects also economical requirements have to be observed for the design of competitive timber structures. These requirements are:

3.2.1 Effective manufacturing and production

– Cost effectiveness

Apart from costs for the fasteners themselves, the manufacturing of timber joints brings also labour costs for the production of the joints. To achieve competitive timber structures as few as possible joints and fasteners systems should be applied in the design. Standardised fasteners and connection systems should, therefore, be used and as few as possible joint parameters (e.g. thickness of steel-plates, diameter of dowels etc.) should be changed in a structure. In addition to decreasing production costs, this also contributes to quality management because of the decreasing danger of confusion on the building site.

– Arguable production tolerances

Production tolerances influence the flexibility and ductility of timber constructions. Because of this, required tolerances should be as low as possible. However, contrary to this, very minimally defined tolerances are leading to high production costs. Consequently, a compromise between the aforementioned two requirements is necessary.

By using innovative fasteners systems (e.g. self-tapping wood screws, “system fasteners“), arguable production tolerances with acceptable costs can be achieved.

– Reliable examination (quality control)

Maintenance and inspection activities for the assessment of structures are becoming a more and more important area of interest within timber engineering. To determine the working order of joints it is necessary to carry out reliable examinations. For joints in situ this is seldom possible. Consequently, a high level of quality control (use of products with defined properties, well educated personal for the production, etc.) during the production process has to be implemented at the manufacturers.

3.2.2 Simple design and computation

– Uncoupled computing of the joints from their design

The design of joints is influencing the “flow-of-forces“ within and the load-carrying capacity of the structure. Therefore, it is an important fact that the calculation is uncoupled from the design of joint.

– Simple design models

Joints can induce complex flows of forces within a structure. To keep efforts for their computing as low as possible and to contribute to the reliability of the timber structure design models and code regulations for joints should be defined as simple as possible.

4 “Flow-of-forces“ in timber joints

4.1 Basics

The “flow-of-forces“ in the joining zone strongly influences the load-carrying capacity of joints and structures. Due to the brittle mechanical behaviour of timber, high load-carrying capacities of joints can only be achieved when high local stresses can be avoided. Disturbances in the “flow-of-forces“ point at high local strains, which are often responsible for failures.

In addition, the visualisation of the “flow-of-forces“ is a valuable tool to understand the mode of operation in timber joints for which reason it will be used in the next subsections for traditional and for some cases of (engineer) designed timber joints.

4.2 “Flow-of-forces“ in traditional timber joints

In traditional timber joints (carpentry joints), the load transfer is done in general by contact areas loaded in compression (mostly in combination with shear-forces). In timber-to-timber joints, the load-carrying capacity is in general small and can be increased by the use of hardwood dowels or steel and gusset plates.

Different shear stress distributions appear, dependent on the loading configurations (in compression or tension), for loaded contact areas. While Joints, loaded in compression, have a more or less even shear stress distribution, the joints loaded in tension show a local maximum (Fig. 10.11). Since the design of the joint has to cover the maximum values as a consequence, the later mentioned load-transfer method has a poor performance.

It has to be mentioned that in Fig. 10.11 stresses perpendicular to grain, which are necessary for mechanical equilibrium, are not shown. These stresses have to be considered in the design process.

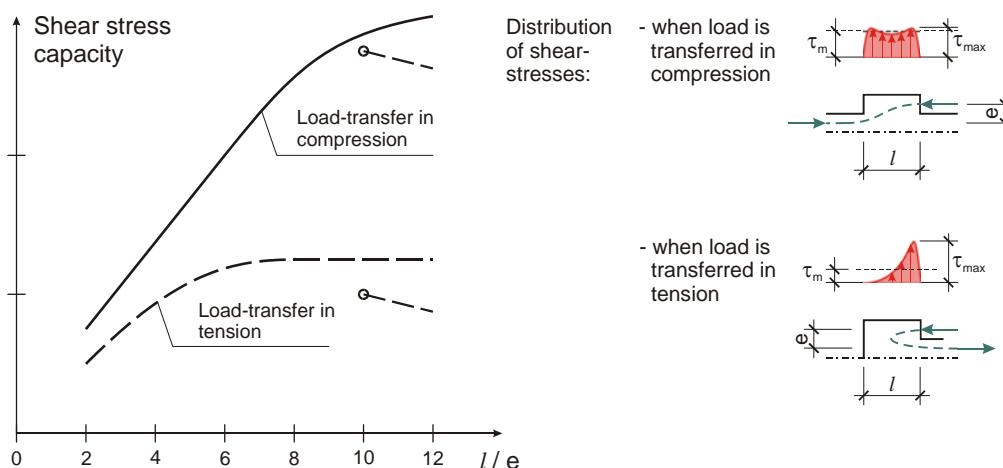

Fig. 10.11 Shear stress capacity und shear stress distributions in traditional timber joints depending on the type of load transfer

It has to be mentioned that in general for joints loaded in combined shear and tension stresses, a strong decrease of the load-carrying capacity has to be taken into account while

for those loaded in combined shear and compression, a small increase of the load carrying capacity can be achieved. This is a well know fact in the carpentry practice and is used, for example, in the design of birdsmouth-joints.

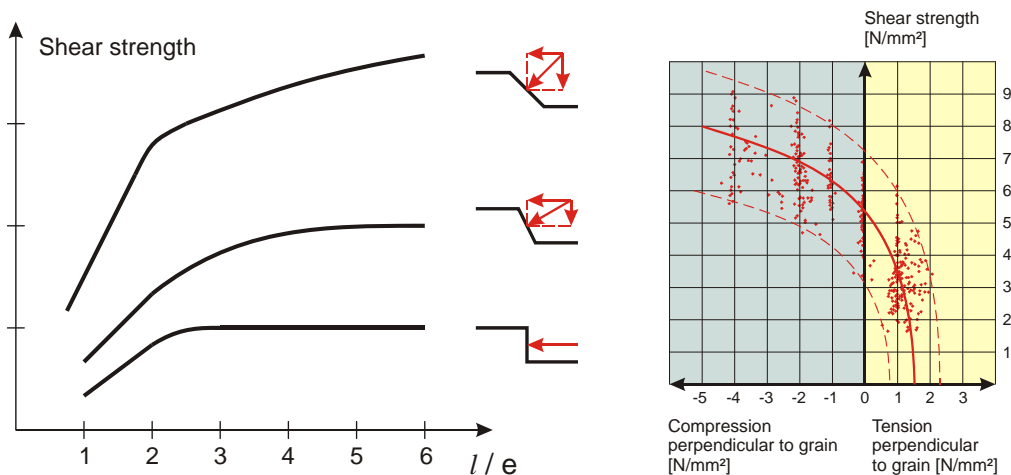

Fig. 10.12 Shear strength of timber when loaded in compression and tension perpendicular to grain

4.3 “Flow-of-forces“ in (engineer) designed timber joints

In comparison to traditional joints a significant increase of the load-carrying capacity can be achieved when fasteners are loaded transversal to their axis (e.g. for dowels, bolts, nails, screws etc.). This is in particular the fact when these fasteners are combined with steel plates. When having a look at the load-transfer, these joints carry the load by contact areas loaded in compression and shear too. But in contrary to traditional joints, these types of connections have an important advantage: because of the use of deformable fasteners (loaded in bending) joints with a ductile behaviour can be produced. This leads to an increased load-carrying capacity. As a condition for the achievement of this option, adequate boundary conditions (spacings and distances of the fasteners) have to be considered during the design process.

The detailed view at the load transfer of a transversal to their axis loaded pin-like fastener in is showing the following facts (Fig. 10.13 and Fig. 10.14): In the embedment zone (contact area between the fastener and the timber member) radial oriented embedment stresses are emerging, which can be separated into parallel and perpendicular oriented stress components regarding the grain. While timber members built-up a relatively high resistance (“embedment strength“) against the first mentioned component only a low resistance exists for the second one. The perpendicular to the grain oriented stress component is loading the timber members in tensile stresses perpendicular to grain and let them split at a low level. (In this context it has to be mentioned, that wood and timber respectively due to its anisotropic behaviour has a very low and highly scattering characteristic of tensile strength perpendicular to grain.)

The last mentioned fact is in particular valid for fasteners with a low slenderness (= ratio between thickness of the timber member to be connected and the diameter of the fastener) and/or small end-spacings of the fastener. In this case the fastener-axis remains more or less unbend and the timber splits. The related failure mode in this case is “brittle”.

If, in contradiction, the fastener has a high slenderness ratio it is deformed in bending, so that the load-carrying capacity of the joint is determined by the (moment-) resistance of the fastener itself. This leads to a reduced splitting tendency of the timber members subsequently a higher load-carrying capacity of the joint and the appearance of a higher (desired) ductility of the fastener/joint.

The consequence of the aforementioned effects is that it makes more sense to use more fasteners in a joint with small diameters than arranging a few with greater one.

Usually in the design process of joints for timber members, only the embedment strength (component in the longitudinal direction) is considered, while the second component (perpendicular to the grain) is implicit included in design rules for spacings and distances of the fasteners. Naturally, the bending capacity (yielding moment) of the fastener plays an important role for the determination of the load-carrying capacity of the fastener/joint. A theory based on (plastic) values for the embedment strength and the yielding moment has been published by Johansen in 1949 and is the basis for the regulation of EN 1995-1-1.

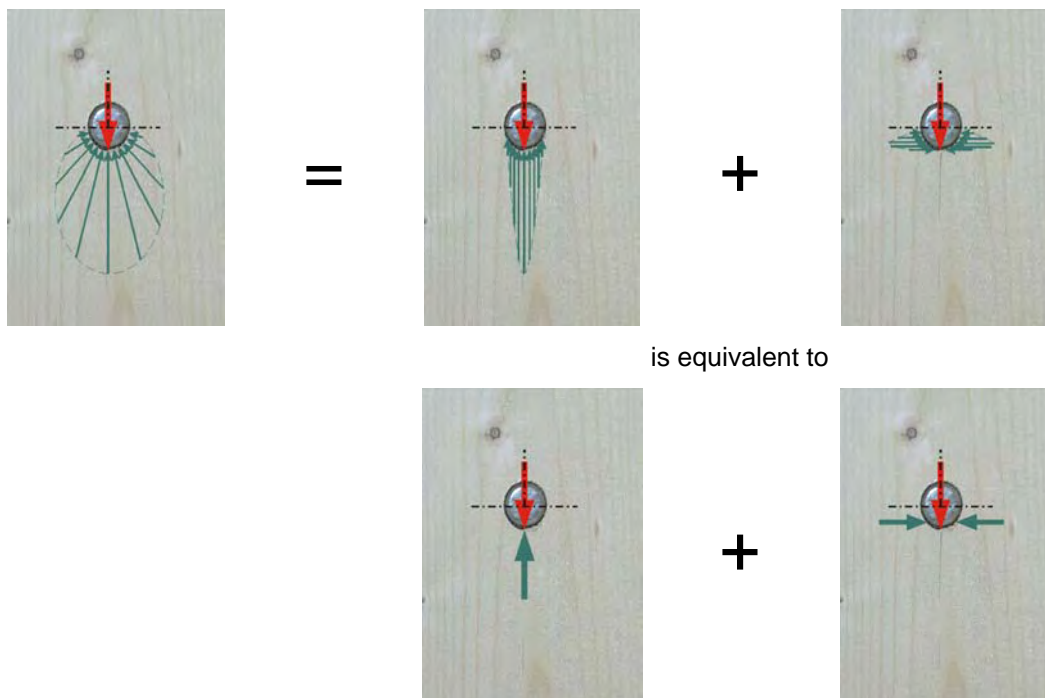

Fig. 10.13 Split-up of radial oriented embedment stresses into a components parallel and perpendicular to grain

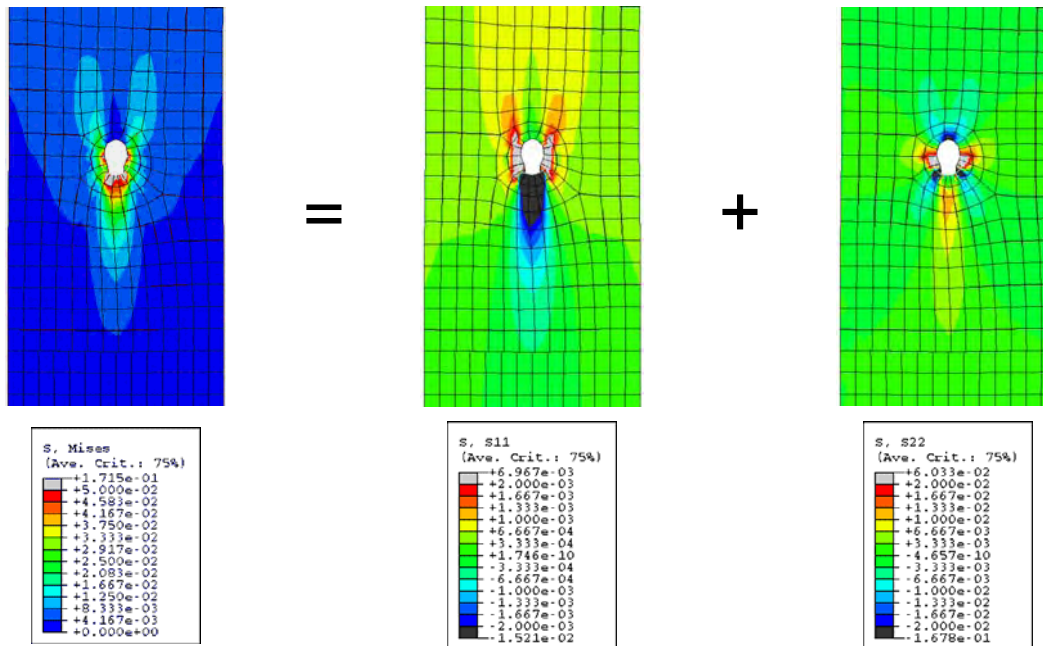

Fig. 10.14 Stress distributions from a FEM-Analysis for the embedment strength and their components according to Fig. 10.13

In the case of loadings perpendicular to grain, splitting of components can be explained in a similar way, but contrary to the loading parallel to grain, the splitting tendency is much smaller. In addition, the load-carrying capacity due to the anisotropy perpendicular to grain is smaller too. It has to be mentioned that failure due to tension stresses perpendicular to grain can occur when loads are introduced. This has to be considered during the design process.

Analogue to the mentioned cases, the load transfer in an angle to grain can be explained.

Another remarkable point concerns the type of load introduction. It has to be mentioned that:

- For load introductions in compression, the loaded area is approximately equivalent to the diameter of the dowel. The “compression shank” shown in Fig. 10.15 is sufficient to ensure the equilibrium of forces.
- In the case of a load introduction in tension, the zone under the fastener is stressed in general with uneven shear stresses. When the load is introduced into the member, due to equilibrium reasons in the outer-zones of the members, a high tensile force is initiated (Fig. 10.16). The necessary width of the “tensile-strings” is determined by the tensile strength of the timber member. Due to the load redirection in the drawn sections 1-1 and 2-2, high shear stresses are initiated. In addition, also tension stresses perpendicular to grain appear under the fastener. The combined activation of shear and tension stresses perpendicular to grain results in an earlier splitting tendency of timber members and decreases the resistance of the joint, respectively. Due to that fact, longer end distances for the timber members are necessary.

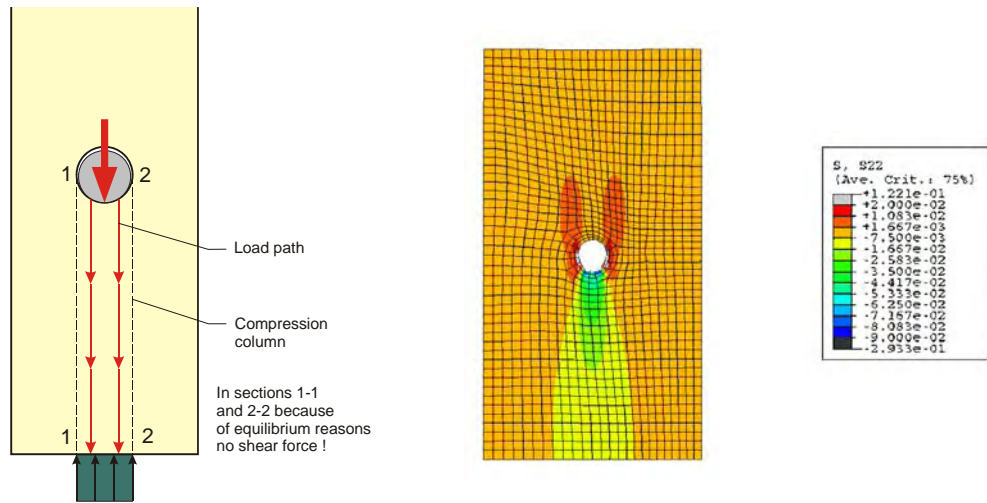

Fig. 10.15 Load introduction of a pin-like fastener in compression

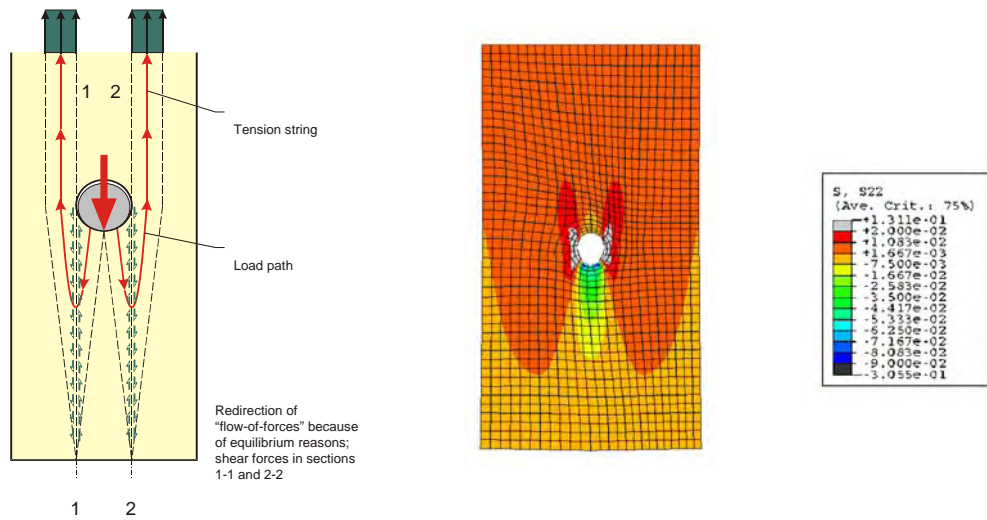

Fig. 10.16 Load introduction of a pin-like fastener in tension

5 Spacings and distances of fasteners

Design specifications for the resistance of fasteners/joints given in standards and codes are based on defined minimum spacings among fasteners and distances to the ends and edges of the timber members respectively. This regulation should prevent in particular the splitting of members. Apart from that also the following reasons require the abidance of spacings and distances:

- “Block-shearing“
- Splitting effect due to inserting fasteners without pre-drilling
- Splitting effects due to shrinkage

Within the European code framework spacings and end-distances are denoted by the following abbreviations:

Type of spacing and distance	Direction of spacings and distances	Abbreviation
Spacings	- spacing parallel to grain	a_1
	- spacing perpendicular to grain	a_2
End distances	- end-distance to the loaded end	$a_{3,t}$
	- end-distance to the unloaded end	$a_{3,c}$
Edge distances	- edge-distance to the loaded end	$a_{4,t}$
	- edge-distance to the unloaded end	$a_{4,c}$

Fig. 10.2 Types of spacings and distances and abbreviation within the European code framework

To achieve a better understanding of the aforementioned spacings and distances they are depicted on some practical examples in the following figure.

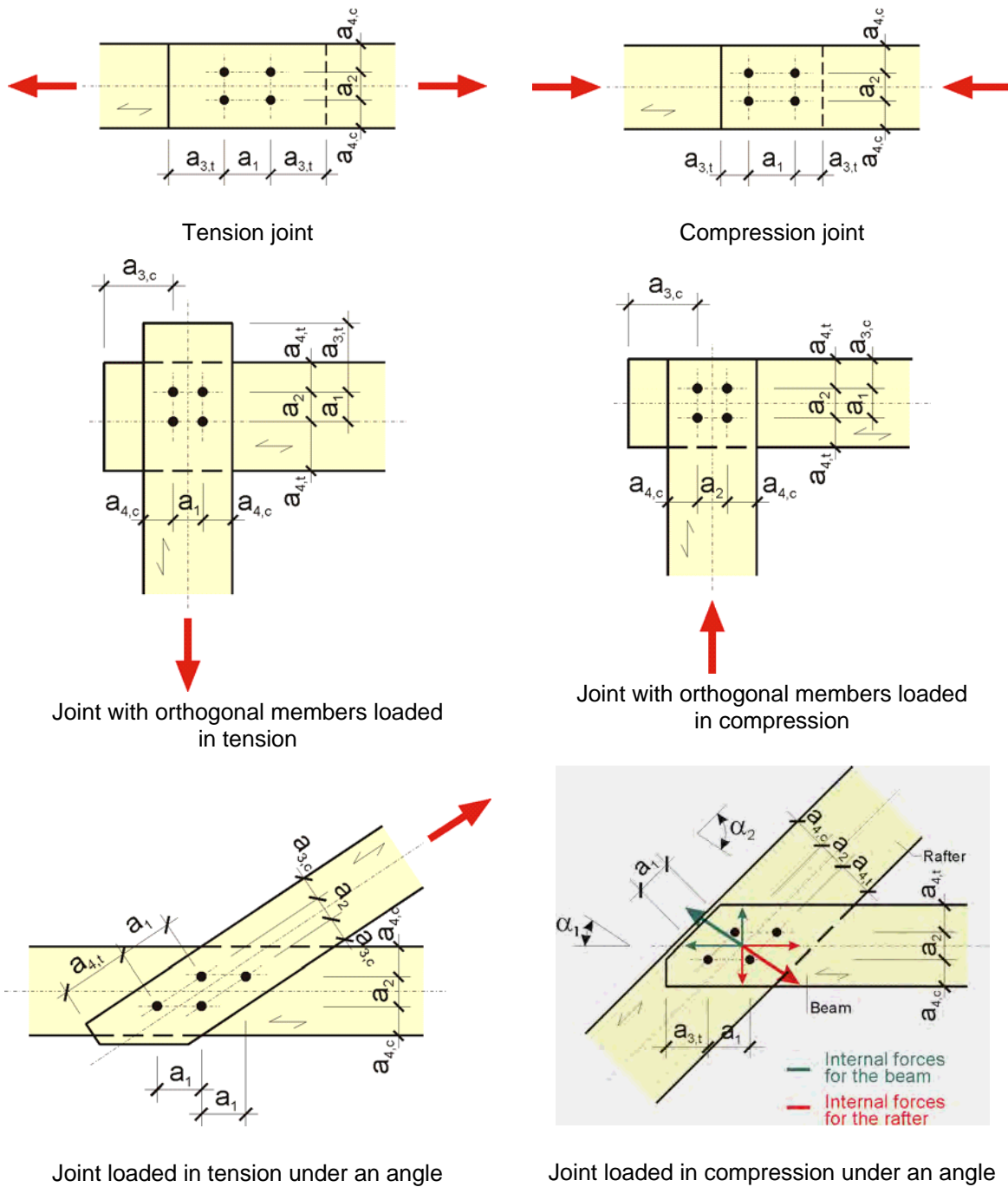

Fig. 10.17 Spacings and distances for some practical cases



6 Fasteners – Joints

The evaluation of different configurations, e.g. diameter of dowels, geometrical positions of fasteners, variation of timber quality etc. would require a huge number of tests. Because of economical reasons, the concept for the computation of fasteners/joints resistance in ULS is to test ONE fastener and calculate the resistance for joints by multiplying this value with the effective number of fasteners of the joint.

Regulations for the determination of fasteners / joints resistance in the ULT in modern standards are also specified in that way. In general joints consist of more than one fastener because of the required load-carrying capacity but also to achieve a sufficient clamping-effect of the members to be connected. Sometimes a joint can also be built up with some groups of fasteners.

From the mechanical and design point of view two aspects have to be considered:

6.1 “Group-effect“

When calculating the load-carrying capacity of a group of fasteners and a joint respectively due to unavoidable uncertainties in the production (production tolerances, geometrical tolerance of the members to be jointed) an uneven load is carried by the fasteners. As a consequence, the load-carrying capacity of joints can not reach the capacity of the sum of the fasteners. This so called “group-effect“ has to be considered in the design by a decreasing factor for the effective number of fasteners (n_{ef}).

6.2 Different flexibilities of fasteners

In general it is possible to use different fasteners types and fasteners with different parameters (e.g. dowel diameter) within one joint. But it has to be considered that their flexibilities should not differ to much because “stiffer“ fasteners are activating higher forces. This leads to the consequence that these members carry loads to a bigger part while “weaker“ fasteners transfer almost no forces.

6.3 Verifications in the design of joints

In general the following verifications in the design of joints have to be done:

- For the fastener
 - Verification of the fastener
 - Verification of embedment strength
- For timber members
 - Verification of net cross-section
 - Verification of “block-shearing“ (if necessary)
- For steel parts (if relevant)
 - Verification of cross and net cross-section

7 Summary – Concepts for high performance joints in timber engineering

High performances of joints in timber engineering can only be achieved when disturbances in the “flow-of-forces” are reduced to a minimum. Using the example of a joint loaded in tension in the following, three practical realisations will be examined with respect to the “flow-of-forces”:

7.1 Relevance of “flow-of-forces”

Type of load-transfer	Net cross-section A_{net}	”Flow-of-forces”	Strain distribution in zone of the joint
<p>Direct-Grain to grain</p> 	100 %	<p>optimal “flow-of-forces”</p> <ul style="list-style-type: none"> - continuous, unweakened cross section - no geometrical disturbances (leading to peaks of stress and strain) - local disturbances due to the wood structure (early-/wood; structure of annual rings, slope of grain) 	
<p>Indirect-parallel to the grain – by means of shear forces</p> 	80 to 85 %	<p>good “flow-of-forces” possible</p> <ul style="list-style-type: none"> - continuous transfer of forces from members to the fasteners (tuning of stiffness by changing A and E) - small deviations between forces and grain direction 	
<p>indirect-perpendicular to grain; by means of local compression longitudinal to the grain</p> 	60 to 65 %	<p>unfavourable ”flow-of-forces”</p> <ul style="list-style-type: none"> - relatively high strain peaks due to uneven local load introduction (due to bending of the fastener) - high load redirection necessary (local load introduction with splitting tendency; compression with shear forces and transformation into tensile forces in net cross-section) 	

Fig. 10.18 Influence of “flow-of-forces” on joints strain distribution



7.2 Relevance of the utilised timber and engineered timber products

Disturbances in the “flow-of-forces“ are already induced by natural given disturbances of the raw material (knots, slope of grain, spiral grain etc.). With transfer of joints location into non-disturbed zones a higher performance of the joint can be achieved.

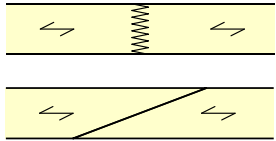
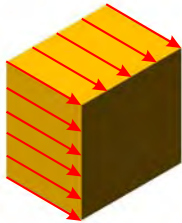
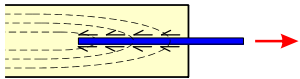
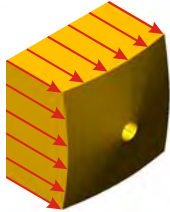
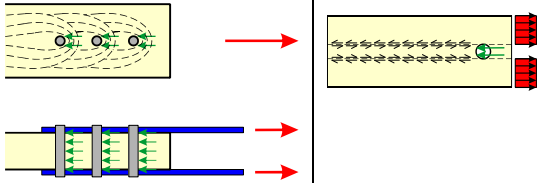
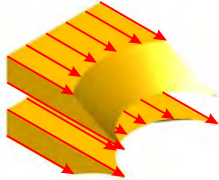
Although this fact seems to be self-evident only for the production of finger-joints rules are given in standards. As a consequence degrees of efficiency $\eta = 1.0$ for joints are possible, i.e. in finger-jointed members the performance of non jointed members can be attained. Appropriate production requirements have to be governed.

7.3 Relevance of ductility

In general a joint consists of more than one fastener. Their continuous loading in ULS assumes a sufficient ductility of the joint. The factor of ductility has to be defined as a function of the desired load-carrying behaviour of the structure.

The desired ductility of the joint has to be obtained by plastic deformations in members of the joint (e.g. in the steel plates). The parts have to be designed appropriately (properties of material, design of parts, etc.).

Local failures (e.g. splitting of the members) of members has to be avoided at all costs (possibly by providing enforcement provisions). Only in that way can the necessary ductility can be obtained.

— Local failure of members within the jointed zone (“splitting“)

In general timber has low strength and shows brittle failure behaviour in tension perpendicular to grain. Possible existing shrinkage cracks may increase the splitting tendency. As a consequence, actions which reduce this tendency (in general as a result of combined shear- and compression forces perpendicular to grain) are desirable.

Such actions can be:

- Increase of the loaded timber volume

By increasing of spacings and distances of the fasteners in the case of indirect load-transfer perpendicular to grain, the resistance against splitting in the embedment zone of the fasteners can be increased too. A continuous distribution of forces perpendicular to grain by using a lot of small fasteners is favourable.

- Increase of resistance against splitting by local reinforcement

Mostly an increase of resistance against splitting is achieved by gluing barriers glued on both sides of the members which will reinforce them perpendicular to the grain (veneer or fibre-reinforced composites). The same effect can be reached by nail-plates or with the use of self-tapping wood screws or glued-rods. In addition, the applied reinforcement leads to a higher embedment strength of the fasteners.



- Substitution with proper engineered wood products in the area of the joint

In this case the whole jointed area has higher mechanical properties concerning embedment strength, tensile strength perpendicular to the grain, etc. For example, high performance veneers with special lay-up or hardwoods can be used for this purpose. An important requirement for this action is the possibility for the production of high-performance finger-joints.

8 References

- [1] N.N.
"STEP 1 – Timber Engineering";
Chapters C1 – C17, First Edition, Centrum Hout, The Netherlands, 1995
- [2] Madsen, B.;
"Behaviour of Timber Connections",
Timber Engineering Ltd., British, Canada, 2000
- [3] Schweizerische Arbeitsgemeinschaft for Holzforschung, Kursleitung: E. Gehri,
"Verbindungstechnik im Holzbau",
Tagungsband zum 32. SAH-Fortbildungskurs, Weinfelden/Switzerland, 2000
- [3] Schickhofer, G.; et.al.
"Holzbau – Nachweisführungen für Konstruktionen aus Holz, Part B",
Lectures notes, Institute for Timber Engineering and Wood Technology, Graz
University of Technology, Graz/Austria, 2004 (in German)
- [4] Thelanderson, S.; Larsen, H.-J. (Publisher);
"Timber Engineering - Part Three: Joints and Structural Assemblies",
John Wiley & Sohns, West Sussex, UK, 2003
- [5] Mischler, A.;
"Bedeutung der Duktilität von Stahl-Holz-Verbindungen",
Dissertation, Professur für Holztechnologie, ETH Zürich, Zurich/Switzerland, 1998
(in German)
- [6] McKenzie, W.M.C.; Zhang, Binsheng;
"Design of Structural Timber to Eurocode 5 – Second Edition",
Palgrave macmillan, New York, USA, 2007

Chapter No. 10 has been prepared by Manfred AUGUSTIN, Institute for Timber Engineering and Wood Technology, Graz University of Technology / Austria.



PLANAR TIMBER STRUCTURES

1 Introduction

This chapter concentrates on timber (wood) planars most common structures like trusses, frames and arches. Timber trusses have some specialties in construction technology and design procedures in comparison to that of frames and arches. For this reason, the Chapter is separated into three main sections:

- Timber trusses,
- Timber frames and arches, and
- Design criteria for these structures.

2 Timber trusses

In the last decades, the application of timber trusses has frequently been apparent in all aspects of building construction. Timber trusses have become known for their pleasing architectural appearance, lightweight design and easy fabrication. The use of timber trusses to bridge wide spans with a few or no intermediate supports is still on the increase. These trusses are essentially lighter than the analogous beam solutions. Many magnificent space and plane timber trusses have been constructed all over the world, covering public halls, stadiums, exhibition centers and many other buildings. In this field, metal-plate-connected timber trusses have been found to be favorable structures for roof framings for spans greater than 20 meters [1].

2.1 Definition and analysis of truss

A structure that is composed of a number of bars that are pin connected at their ends to form a stable framework is called a truss. If all the bars lie in a plane, the structure is a planar truss. It is generally assumed that loads and reactions are applied to the truss only at the joints. The centroidal axis of each member is straight, coincides with the line connecting the joint centers at each end of the member, and lies in a plane that also contains the lines of action of all the loads and reactions. However, in many cases, such as bridge structures and simple roof systems, the three-dimensional framework can be subdivided into planar components for analysis as planar trusses without seriously compromising the accuracy of the results. Figure 11.1 shows some typical idealized planar truss structures. A stable and statically determinate plane truss should have at least three members, three joints, and three reaction components. The method of joints is a technique of truss analysis in which the bar forces are determined by the sequential isolation of joints. The unknown bar forces at one

joint are solved and become known as bar forces at subsequent joints. The other method is known as method of sections in which equilibrium of a part of the truss is considered [2].

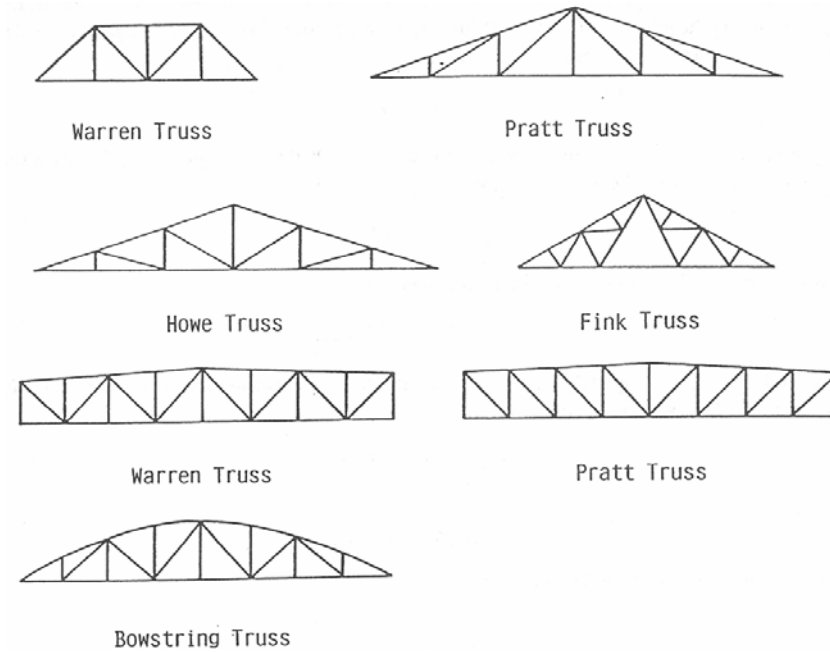

Fig. 11.1 Some typical idealized planar truss structures [2]

A compound truss is formed by interconnecting two or more simple trusses. Examples of compound trusses are shown in Fig. 11.2.

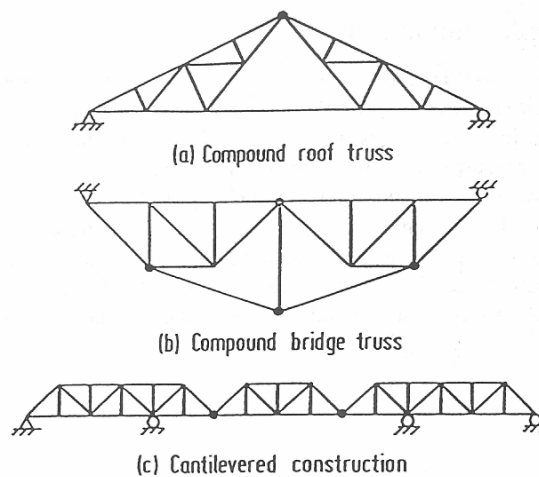

Fig. 11.2 Compound truss [2]



2.2 History, product technology and design aspects of timber trusses

Trusses made with metal gusset plates with punched teeth have, during the past 35 years, become the most common form of wood truss. Since 1960, the use of these metal-plate-connected wood trusses has virtually displaced conventional residential roof framing. Trusses fabricated in this fashion are largely pitched or parallel-chord (flat) trusses in the span range of 6-20 m and erected on spacing centers of 0.6-3 m.

Trusses with tubular steel webs are another example of the effective combination of two materials. Timber chords have the large cross-sectional dimensions necessary for lateral stability and compressive stiffness, both important features of a truss, while pinned steel tubes minimize joint slip and provide strength and manufacturing economy in producing the connections. Material and labor economies combine with structural attributes in this sort of marriage of two materials. Heavy timber roof trusses constructed with bolts, split rings and shear plates, using steel gusset plates and tension tie rods, are used on spans of 15-30 m. The design of such structures has been practiced for hundreds of years, although the development of modern connectors, glued-laminated material and treated wood has given a new dimension to these styles of construction.

The basic types of truss are pitched, flat and bowstring. The pitched truss is the most efficient type for center-point loading, but its selection is more often based on the need for roof drainage and the shedding of snow loads. Pitched trusses are commonly used to carry uniformly distributed loads or loads placed at numerous regular locations along their length. Pitched trusses are used in residential, commercial, industrial and agricultural applications.

The parallel-chord truss would be the least efficient type where it is not possible to reduce the size and grade of members at intervals of low stress along the span. By proper choice of sizes, flat or cambered parallel-chord trusses can be reasonably efficient. This type of truss, with camber and a moderate top-chord pitch to permit drainage, fits into many architectural plans. Residential floor trusses represent a special application of this kind of truss. From a consumer standpoint, floor trusses have several attractive features over the conventional floor joist system. The first advantage is that with this type of truss a clear span can be obtained, allowing free movement of people and various items used or stored there. Second, the floor trusses provide a space between the truss webs for the placement of heating and cooling ducts, plumbing and electrical and other mechanical equipment. And third, the flat wise orientation of the lower chord allows for easy nailing and installation of a ceiling by the home owner at a later time when finished space is needed. Typical spans for floor trusses is 7-10 meters, with a depth of 30-50 cm, respectively.

The bowstring truss is considered the most efficient in terms of material utilization when the load is uniformly distributed. It is also usually used for bridges with moving loads. Bowstring trusses are very widely used in a number of forms that do not develop the full efficiency of the bowstring concept but take sufficient advantage of it to produce some worthwhile structural and cost benefits. The bowstring truss principle treats the top chord as a compression arch. The top chord is approximately parabolic. Under a uniformly distributed load, the vertical component of a top chord force in a theoretically designed bowstring truss will be equal to the vertical shear at any point. No web members are necessary under these conditions. In practice, loads are not always uniformly distributed so web members are necessary. Bowstring trusses are not actually manufactured to a parabolic top-chord curvature but are usually in the form of a circular arc, proportioned so the radius of curvature is equal to the span or to give midspan depth suited to the allowable stress, chord area, and bending moment.



The ratios of depth to span generally recommended for various truss configurations are 1:6-1:8 for bowstring, 1:5-1:6 for pitched and 1:8-1:12 for flat. These ratios are not inviolate and may change as materials of different qualities are used and as improved connection systems are devised. Deeper trusses deflect less and require smaller chord members. Minimizing the number of panels reduces fabricating costs, both in terms of labor and hardware. From the structural point of view, lateral symmetry is a desirable feature of a truss. It improves end fixity of web members and compression chords, eliminates eccentric loading, and simplifies structural analysis.

The professional truss designer should be familiar with all plate-related procedures. The plate manufacturers have conducted tests and secured approval for design values from the building and housing authorities. There are times, however, when the designer needs to execute a completely independent design. The plates are installed on both sides of the trusses at each panel point. Plates must have sufficient strength to carry tensile, compression and shear loads. Void areas left by drilled nail holes or punched-out teeth must be subtracted from the plate section area to obtain the net plate cross-section area for design. Tight-fitting compression joints at other locations may also be credited with compression in direct end-grain bearing.

Probably 50% of all roof failures can be attributed to inadequate temporary or permanent truss bracing. Temporary bracing is used during construction to secure all parts involved while the various components of the roof system are being installed. Overnight destruction due to a windstorm coupled with inadequate temporary bracing has been reported on more than one occasion. The installation of appropriate bracing is the key to the structural integrity of the truss system [3].

3 Timber frames and arches

Timber frame construction is perhaps the oldest type of timber structure and has received renewed attention in specialty markets in recent years. Prefabricated panelized construction has also gained popularity in recent times. Both framed (similar to light-frame construction) and insulated (where the core is filled with a rigid insulating foam) panels are used. The frame method of construction is now widely accepted for commercial and industrial applications. In many countries around the world timber frame construction is widely used for retail stores, warehouses and manufacturing buildings. Churches, fire stations, repair garages and parking garages often are of the timber frame style. Some interesting residential and recreational structures have employed this type of construction [3].

3.1 Definition and analysis of frame

Frames are statically indeterminate in general therefore special methods are required for their analysis. Slope deflection and moment distribution methods are two such analytic methods commonly employed. Slope deflection is a method that takes into account the flexural displacements such as rotations and deflections and involves solutions of simultaneous equations. Moment distribution on the other hand involves successive cycles of computation, each cycle drawing closer to the "exact" answers. The method is more labor intensive but yields accuracy equivalent to that obtained from the "exact" methods. This method, remains one of the most important hand-calculation methods for the analysis of frames [2].

3.2 Timber frame and arch design aspects

Timber frames with all kinds of shapes have been well accepted in recent years. Special attention is dedicated to connections (corners) between girders and columns. These can be solved in two different ways form of a building technology and construction point of view.

First is columns buildup from two elements under different angles act as one tension and one compressed element. Second is rigid connection between them made of metal fasteners or of one continuous element column-girder made from curved glued laminated timber – there on we can took about arch. Special attention must be expected from designer's point of view on such connection investigation (combination of two different grain direction and different stress components in curved girder-column element). The girder element can be under an angle from the connection to the pitch create needed roof inclination or can be made of tapered non-constant section beam. All that types of bigger frames – either two- or three-hinged arches – are made of glued laminated timber (homogenous or combined-composite) from which a large variety of cross section types can be created (Fig. 11.3). Economic spans for frames are from 15 to 60 meters and for arches from 20 to 100 meters.



Fig. 11.3 Example of a glulam arch

The wall girts (horizontal wall rafter) carry the wall wind loads to the columns. Cladding (siding) and sheathing, if used, are attached to the girts. The roof beams support the usual metal roofing or plywood sheathing. Beam spacing for roofs range from 1 to 4 meters. For walls and ceilings inside buildings with requirements concerning the appearance of the surface the outermost layer is often a gypsum board or a wood based panel.

A rigid unbraced frame should be capable of resisting lateral loads without relying on an additional bracing system for stability. Practical connections are semi-rigid in nature and therefore the pinned and rigid conditions are only idealizations. They are normally located in buildings to accommodate lift shafts and staircases. The main function of a bracing system is to resist lateral forces. Building frame systems can be separated into vertical load-resistance (represented in Fig. 11.4 for timber frames) and horizontal load-resistance systems. In some cases, the vertical load-resistance system also has some capability to resist horizontal forces. It is necessary, therefore, to identify the two sources of resistance and to compare their behavior with respect to the horizontal actions [2].

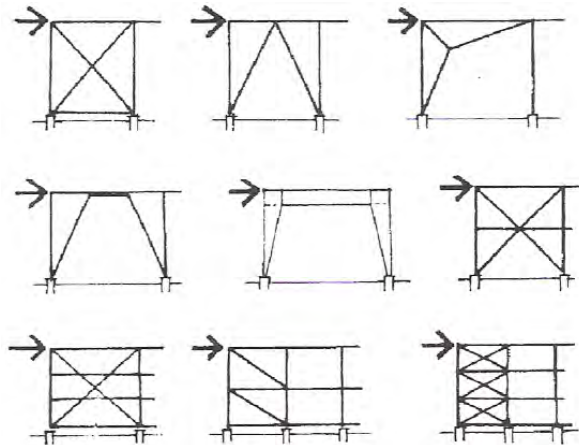

Fig. 11.4 Bracing systems of timber frames [6]

The identification of sway frames and non-sway frames in a building is useful for evaluating safety of structures against instability. In the design of multi-story building frames, it is convenient to isolate the columns from the frame and treat the stability of columns and the stability of frames as independent problems. If knee braces are used they must be of adequate size and with connections designed to carry their loads. Care must be taken that the braces do not produce undesirable bending moments in the trusses (if a truss is used instead of a massive girder). The entire frame, consisting of columns, trusses, and braces, should be analyzed and designed structurally [2].

Wood-framed buildings are often sheathed with metal roof panels supported on timber purlins that run at 90 degrees to the girder or column. These panels possess shear resistance to the lateral forces on the building. Each load is a lateral force equal to the wind (or seismic) load tributary to the building frame. Roof panel shear stiffness is a combination of sheathing shear stiffness, fastener stiffness, and the contributions of beams and blocking in the prevention of the sheathing from buckling. The stiffness of panels is determined by testing of particular panel constructions [3].

4 Timber truss, frame and arch design criteria

The design criteria for timber trusses, frames and arches are the same to those for a timber beam or any timber element at all and should be either stress-controlled (ultimate limit state) or deflection-controlled ones (serviceability limit state).

4.1 Ultimate limit state for trusses and truss members (ULS)

The design criteria for trusses are similar to those for a beam. Allowable bending, tension, compression and shear stresses are limited by the choice of the timber grade (quality) and consequently its design strength. Compression perpendicular to the grain at points of truss bearing must be checked for all truss designs. Roof truss support connections must also be designed to resist uplift caused by wind pressures. Actual dead loads can be substantially less than the design dead load value, so one should subtract no more than the actual dead weight of the structure for the uplift design.



Chord and bracing (diagonal and vertical) tensile or compressed (sometimes with bending) members must be checked for the ultimate limit state, defined in Eurocode 5 [4], Section 6. Tension and compression forces (and sometimes bending moments) are limited by the choice of the timber quality and its design strength. Very often the contribution of the local bending moments can be neglected. It is recommended that when a simplified analysis is carried out for trusses, which are loaded at the nodes, the tensile and compressive stress ratios as well as the connection capacity should be limited to 70 %. The outer-external elements in trusses must be treated for design like continuous beams if the elements really reach over two or several bays (fields). For trusses which are loaded predominantly at the nodes (when buckling is not considered), the sum of the combined bending and axial compressive stress ratios should be limited to 0.9. In all other conditions, Eurocode 5 [4], Chapter 9.2.1, also applies.

For lattice columns with N or V-lattice configurations with glued or nailed joints, assumptions stated in Eurocode 5 [4], Chapter C.4.1 apply. For column stress and buckling analysis criteria, the use of Eurocode 5 [4], Chapter C.4 and 6.3. is recommended.

For members in compression, the effective element length for in-plane strength verification (buckling analysis) should generally be taken as the distance between two adjacent points of contra flexure. For fully triangulated trusses, the effective column length for members in compression should be taken as the bay length if members are only one bay long, without rigid end connections and equally for members which are continuous over two or more bays and are not loaded laterally. An adequate check shall be made for the lateral (out-of-plane) stability of the truss members (see also section 4.4).

4.2 Ultimate limit state criteria for frames and arches

The effects of induced deflection on internal forces and moments may be taken into account by carrying out a second order linear analysis with the assumptions stated in Eurocode 5 [3], Chapter 5.4.4. The stress criteria of the members with combined loadings like tensions or compression combined with biaxial bending is described by expressions stated in Eurocode 5 [3], chapters 6.2.3, 6.2.4 and with consideration of stability problems by expressions stated in Eurocode 5 [3], chapters 6.3.2, 6.3.3. If one or more loads in mentioned expressions does not exist, the expressions become (simpler) shorter for missing stress conditions. Members must be also controlled for shear stress conditions caused either by shear forces or torsion moments or a combination of both.

Lateral torsional stability of an arch or frame element then shall be verified according to Eurocode 5 [3], Chapter 6.3.3.

For members in compression, the effective element length for in-plane strength verification (buckling analysis) should generally be taken as the distance between two adjacent points of contra-flexure. For timber sway frames, the effective member length are shown in Fig. 11.5 (usually all simple timber frames without bracing are treated as sway).

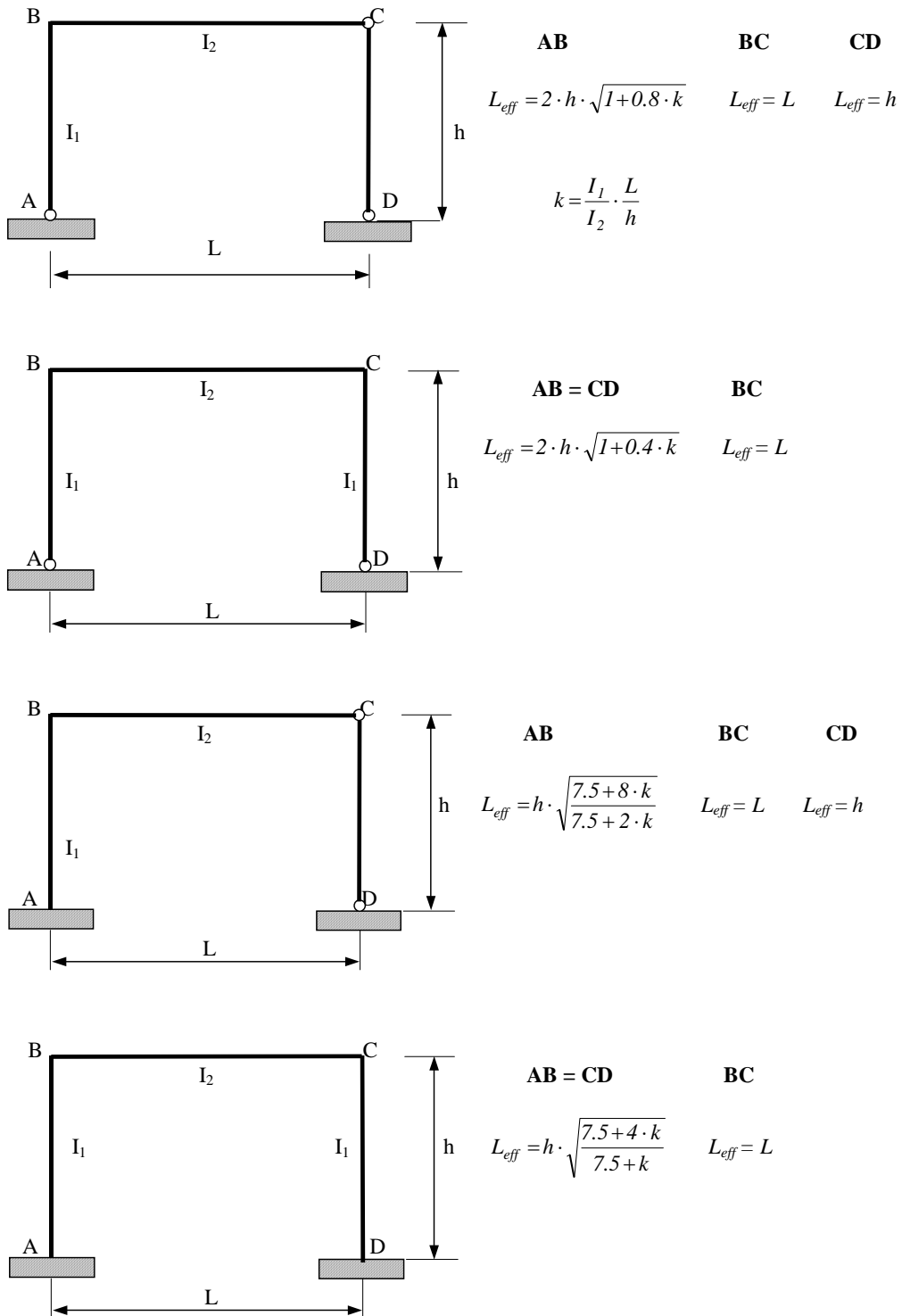

Fig. 11.5 Effective (buckling) member length for frames

Coefficient k denotes the rigidity of restraint at the element ends and is determined as:

$$k = \frac{E_1 \cdot I_1 \cdot l}{E_2 \cdot I_2 \cdot h} \tag{11.1}$$

In braced non-sway frames, the effective element length is determined on the isolated member of the frame and treats the stability of the member as an independent problem. Effective (buckling) element lengths in such cases are for wood based elements: for two side clamped members $L_{eff} = 0.65 \cdot L$; for two-hinged members $L_{eff} = 1.0 \cdot L$; for one-side clamped and other side hinged members $L_{eff} = 0.8 \cdot L$; for cantilever $L_{eff} = 2.0 \cdot L$ if L represents the structural length of the member. A check must be made that the lateral (out-of-plane) stability of the frame is adequate.

For in-plane stability analysis of arches, the following values for effective length are acceptable: for two-side clamped arches under symmetrical load $L_{eff} = 0.5 \cdot s$; for two-hinged arches under symmetrical load $L_{eff} = 0.625 \cdot s$; for three-hinged arches under symmetrical load $L_{ef} = 0.7 \cdot s$; for two or three-hinged arches under non-symmetrical load $L_{ef} = 0.5 \cdot s$; (for s see Fig. 11.7).

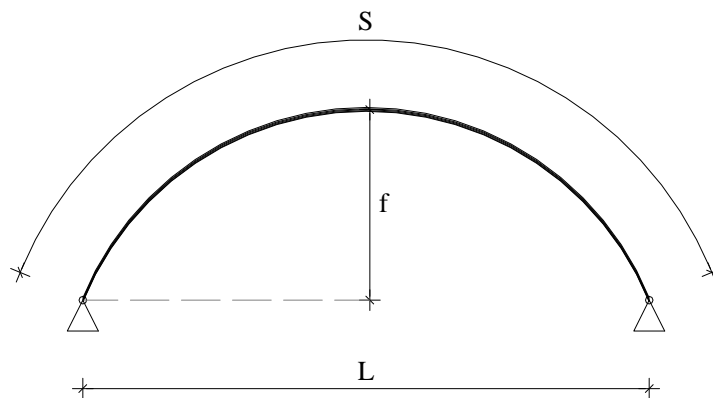

Fig. 11.6 Effective arch length

For bigger arch elements, the following expressions are valid (for parameters see Fig. 11.6):

$$L_{ef} = 0.5 \cdot l \cdot \sqrt{1 + 6.15 \cdot k} \quad k = \frac{f}{l} \quad \text{two-hinged arch} \tag{11.2}$$

$$L_{ef} = \frac{l}{1.75} \cdot \sqrt{1 + 2 \cdot k} \quad k = \frac{f}{l} \quad \text{three-hinged arch} \tag{11.3}$$

An adequate check shall be made for the lateral (out-of-plane) stability of the arch.



4.3 Connections

In general a slip influence in connections should be taken into account through their stiffness (rotational or translational for instance) or through prescribed slip values as a function of the load level in the connection. Fasteners in all joint connections should satisfy the ULS criteria according to Eurocode 5 [4], Chapter 8. The frame analysis should be carried out using the appropriate values of member stiffness. Fictitious beam elements should be assumed to have a stiffness corresponding to that of the actual connections.

The joints in trusses shall be capable of transferring the forces which may occur during handling and erection according to Eurocode 5 [4], Chapter 9.2.1. In most cases it can be assumed that truss elements are connected together with metal fasteners because glued connections are infrequent in trusses. Axial forces in the members should be determined on the basis that every connection-node is pin-jointed if we wisely use connections with metal fasteners. The timber members or steel tensioned intermediate elements can be double-shear or single-shear connected with steel or wood plates. Only the symmetrical connections are recommended for use to prevent any other than coincidental eccentricity, which is a consequence of the imperfect shape of the structure. Connections made with punched metal plate fasteners shall comprise punched metal plate fasteners of the same type, size and orientation, placed on each side of the timber members. The plate should satisfy the criteria given in Eurocode 5 [4], Chapter 8.8. Splice connections used in lattice structures may be modelled as rotationally stiff if the actual rotation under load would have no significant effect upon member forces. This requirement is fulfilled if conditions stated in Eurocode 5 [4], Chapter 5.4.2 (9) are satisfied.

4.4 Bracing of single truss, frames or arch and systems made of it

For single elements in compression like single truss, frame or its elements, requiring lateral supports at intervals "a", the initial deviations from straightness between supports should be within $a / 500$ for glued laminated or LVL members, and $a / 300$ for other members. Each intermediate (bracing element) support should have a minimum spring stiffness "C" described by the expression in Eurocode 5 [4], Chapter 9.2.5.2 and should be capable to resist design stabilizing force (F_d) that occur at each; the kind of support which is also stated in Eurocode [4], Chapter 9.2.5.2. Danger of lateral torsional instability can be successfully prevented with similar efficient bracing systems in accordance with Eurocode 5 [4], Chapter 9.2.5.2 (4).

For a series of n parallel members like truss, frame or arch systems, which require lateral supports at intermediate nodes, a bracing system should be provided, which (in addition to the effects of external horizontal load like wind), should be capable of resisting an internal stability load per unit length q_d , as stated in Eurocode 5 [4], Chapter 9.2.5.3. The horizontal deflection of such a bracing system due to force q_d and any other external load should not exceed $l / 500$. The example of such a bracing system is shown on Fig. 11.7, either for a frame or for an arch system (similar for truss system).

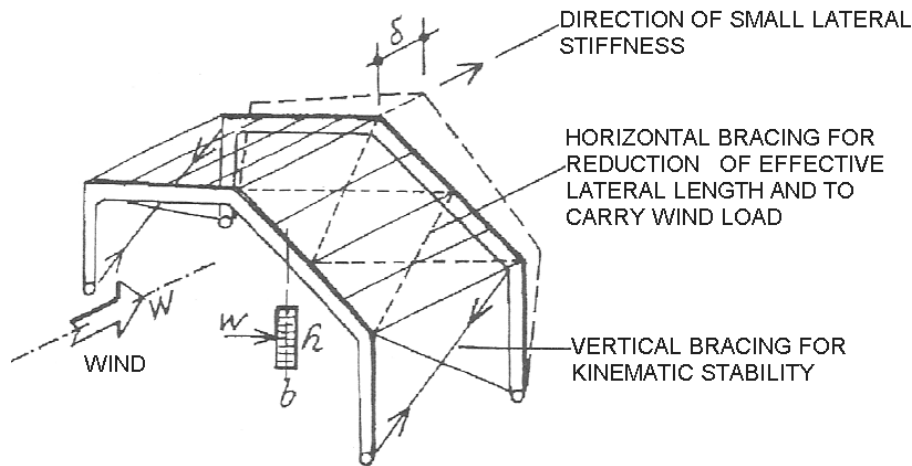

Fig. 11.7 Frame bracing system [6]

4.5 Serviceability limit state criteria for timber truss, frame and arch design

Serviceability limit states for deflection require that the maximal initial and final deflection must be calculated within a specified range. Initial elastic deformation can be calculated with the following expression:

$$u_{inst} = u_{inst,M} + u_{inst,V} + u_{inst,N} = \int_S \frac{M_{y(x)} \cdot \bar{M}_{y(x)}}{E_{mean} \cdot I_{y(x)}} dx + \int_S \frac{V_{z(x)} \cdot \bar{V}_{z(x)}}{G_{mean} \cdot A_{S(x)}} dx + \int_S \frac{N_{x(x)} \cdot \bar{N}_{x(x)}}{E_{mean} \cdot A_{(x)}} dx \quad (11.4)$$

Since the members are flexibly connected, their stiffness decreases. In finite element analysis we consider the joint flexibility (for example in truss members) in such a way that cross-section areas A_m of all members (that are flexibly connected to the truss chords) are replaced by a fictitious decreased cross-section area A_m^* according to Steck [5]. It should be noted that form A_m^* can also be used for the calculation of internal forces, but by respecting the reduced value for the stiffness of the fasteners. In this case, considering $K_u = 2/3 \cdot K_{ser}$ instead of K_{ser} according to Eurocode 5 [4], Section 7.

The total deflection should not exceed the range of limiting values for beam deflections, depending upon the level of deformation deemed to be acceptable. The instantaneous and final deflection is limited with the recommended values given in Table 7.2 of Eurocode 5 [4].

For structures consisting of members, components and connections with the same creep behavior and under the assumption of a linear relationship between the actions and the corresponding deformations, the final deformation, u_{fin} may be taken calculated according to Eurocode 5 [4], Chapter 2.2.3.



5 References

- [1] Šilih, S., Premrov, M., Kravanja, S.;
“Optimum Design of Plane Timber Trusses Considering Joint Flexibility”,
Engineering Structures 27(1), p. 145-154; 2005
- [2] Chen, W.F.;
“Handbook of structural engineering”,
New York, Boca Raton: CRC Press, 1997
- [3] Hoyle, R.J., Woeste, F.E.;
“Wood Technology in the Design of Structures”,
Ames, Iowa: Iowa State University Press, 1989
- [4] CEN/TC 250/SC5 N173,
“EN 1995-1-1:2004, Eurocode 5: Design of Timber Structures, Part 1-1: General rules
and rules for buildings”;
Brussels, 2004
- [5] Steck, G.;
“Fachwerkbinder aus Brettschichtholz und Vollholz”,
from “STEP 2 – Holzbauwerke: Bauteile, Konstruktionen, Details nach Eurocode 5”,
Chapter E7/1-12, Düsseldorf: Fachverlag Holz; 1995 (in German).
- [6] Gojkovič, M., Stojič, D.;
“Drvene konstrukcije”,
Beograd, Faculty of civil engineering, Grosknjiga, 1996

Chapter No. 11 has been prepared by Miroslav PREMROV and Matjaz TAJNIK, Faculty of Civil Engineering, University of Maribor / Slovenia.



SPATIAL STRUCTURES

1 Introduction

The chapter deals with spatial, mainly roof, structures of timber-based materials. These structures represent technically and economically effective and architecturally impressive ways of solving wide span roofing.

2 Specification of spatial structures

The term spatial structure can be understood as structural systems that are able to transmit all load actions straight to the support system and foundations. The spatial structure looks like one unit – a spatial object. When designing and testing spatial structures it is necessary to respect mutual co-influence of single load-bearing parts. It is not possible to apply a solution by disintegration of a structure on individual, mutually independent parts because it would not be in correspondence with the real behaviour of the structure.

In nature it is possible to find many inspiring examples of “spatial structures”, such as eggshells or nutshells, spider webs, soap bubbles, shells, snail shells, etc.

In civil engineering it is also possible to find examples of spatial structures realized even in the Antiquity. For example, the dome of the Pantheon in Rome built by Agrippa in 27 B.C., which was the largest dome until modern times with its span of 43 m. Other examples of spatial structures are tents of Asian steppe nomads.

The development of spatial structures has generally started in the last 50 years in relation with the development of computer technology and software. This development can also be noticed in the field of timber spatial structures.

The use of spatial structures brings certain advantages in comparison with plane structures:

- All structural elements contribute to the load-carrying capacity, which often leads to material savings.
- Loads are distributed more evenly to the supports.
- There is a wider choice of supports and shapes (variability).
- Deflections are reduced when compared with planar structures of similar weights.



- Spatial structures prove a high redundancy of reliability. Failure of a limited number of elements (apart from space structures) does not necessarily lead to the overall collapse of structures and consequently they have a good resistance to damage caused by fire, explosion or seismic activity.
- Spatial structures are usually modular, which enables high degrees of prefabrication and thus related advantages (work precision, easier transport and assembling).
- In the spatial bearing structure is easier to make various installations.
- Spatial structures usually look very aesthetic and uncommon.
- The use of spatial structures, however, brings some disadvantages as well, which are as follows:
 - They are costly, which can be high when compared with alternative structural systems, particularly when space frames are used over short spans.
 - The number and complexity of joints can lead to a longer erection time on the site depending on the joint type and grid module chosen.
 - When fire protection is required they are more expensive due to a great number and relatively large surface area of the space frame elements.

3 Classification of spatial structures

Spatial structures can be divided according to many different criteria. The basic classification concerns their classification according to:

- Geometric shape
- Construction
- Surface structure

3.1 Geometric shape

Geometric shapes of spatial structures can be divided according to different views. Planes of spatial structures can be created by translation or rotation of segments or curves according to principles of descriptive geometry. For example, cylinder surface can be characterized as a rotation surface formed by rotation of a line around the centre of rotation or as a translation surface formed by translation of conic section along the line. Similarly, hyperbolic paraboloid can be described as a line surface formed by a system of lines connecting relevant points on two nonintersecting lines or it can be created by translation of parabola on parabola. A geometric shape should be defined from the viewpoint of its **static behaviour and structural analysis**. It is its **curvature** that has the greatest effect on the static effectiveness of spatial structures.



Spatial structures can be classified as:

- Slab spatial structures
- Folded plate structures
- Shell surfaces of single curvature
- Shell surfaces of double curvature

3.2 Construction

Structural design captures a way of realization, i.e. structural application of particular geometrical surface. For example, a cylindrical surface can be designed in a shape of a vault or can be suspended. Possibly, a so-called shed roof can be created as well.

3.3 Surface structure

The realized bearing part of the plane of a spatial structure (without roofing and insulation layers) can be created as a **compact-solid**, which is a surface with tapered thickness that can be changed on the surface due to stress. This structural type is called a **continuous structure**. **Continuous – reinforced structure** is created by reinforcing the continuous structure with ribs in certain intervals on the whole surface. A **net** structure arises when the surface consists of trusses lying on one plane (or on a curved surface) and mutually connected in joints. If the bars are not located in one plane and the joints are spatial, a so-called **framed** structure arises. With a large span, where it is often the surface resistance to buckling, which is a criterion of bearing capacity, it is possible to design a structural system with a **double shell**.

From another point of view, spatial structures can be divided into **truss, solid or combined** structures. Truss structures are created by spatially arranged and mutually connected trusses. Solid structures (folded plates and shells) are created by planar elements. Combined structures are created by mutual connection of bar and surface members in joints and along edges.

4 Types of spatial structure roofing

4.1 Slab structures

Geometrically, slab structures can be defined by planar middle surfaces. This category is represented by ceiling slabs and slabs with net structures.

Ceiling panels are slabs with continuously reinforced structures consisting of a frame with bearing ribs and sheathing from large-area plates.

Slabs with net structure can be, with respect to orientation of the bearing structure, designed in orthogonal or diagonal systems.



Technically, the most difficult detail is represented by the joints of the structure; those are places of bars crossing where it is necessary to eliminate the weakening of elements in the maximal way.

4.2 Folded plates

A folded plate is a crank-bearing element consisting of thin wall-slab elements. Timber-based folded plates have been produced since the half of the 20th century. The walls are usually designed of large-area material slabs (usually plywood) connected at an angle of 40° - 50°. The advantages of gable structures are their structural variability and a higher static efficiency in comparison with other planar structures.

4.3 Shells

Shells are thin and stiff membranes which independently secure roofing, including the bearing structure and shape of the roof surface. The shell thickness is very small due to all its dimensions. Strength and stiffness of a shell depend on its curvature. Shell surfaces can be single or double curved. Double-curved shell surfaces are usually stiffer than the single-curved ones. Slightness of a shell is enabled by its behaviour as a surface structure; however, this is conditioned by a high-quality design, clearly designed details and careful production. Shell surface structure can be either compact (made of glued layers of mutually crossed boards) or continuously reinforced, or of net structure (lamelled).

4.3.1 Shell surfaces of single curvature

Shell surface of single curvature are supported either on frontal bond timbers and then they impact as frameless bodies of given diameter, or they are supported along the circumference and then they impact as thin vaults.

This category includes cylindrical surfaces and conoids.

Laminated vaults are usually designed as cylindrical bearing surfaces with new structure, which are supported mainly in step lines. The circle is usually the director curve.

An example of a laminated vault of 30 m span, camber of 17 m and length of 42 m is shown in Fig. 12.1. The vault was used for the sports hall roofing in 1950s in the city of Ostrava (Czech Republic) and still fulfils its functions. The principal lamella of the vault is made of shapely wood of diameter 45/270 mm. Pairs of steel screws connect lamellas. Figure 12.2 shows the detail of lamellas connection at the vault's peak.

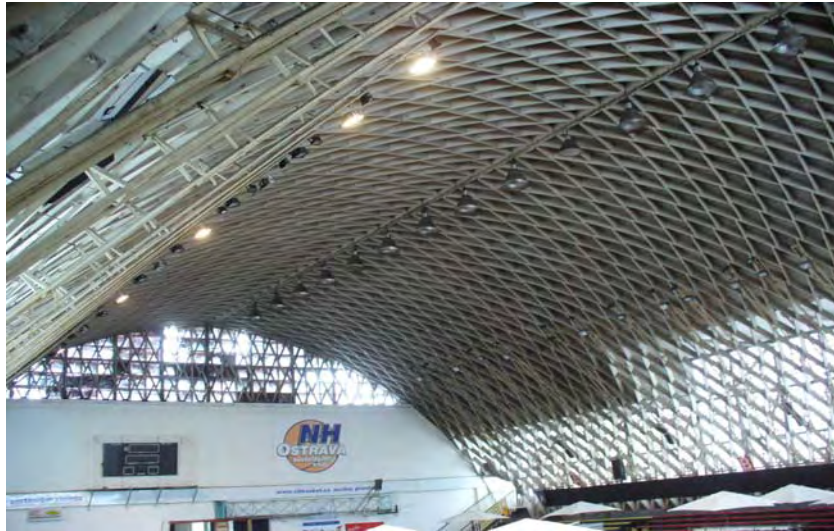

Fig. 12.1 Lamellar vault of the sports hall roof



Fig. 12.2 Detail of lamellas connection of the sports hall vaults

4.3.2 Shell surfaces of double curvature

This category comprises both rotation symmetric structures on a circular or polygonal ground plan (cupolas, domes) and translation surfaces above any plan.

4.3.3 Rotation surfaces – cupolas and domes

Domes are shell structures that transmit loading by mainly membrane forces. This very efficient way of carrying loads is achieved by a way of tension, compression and shear forces in the plane of the shell, which means that the stresses are evenly distributed throughout the cross-section and hence thin-walled constructions are possible. Therefore, these slender types of construction must be properly evaluated with regard to the local buckling problem (compression loads causing a deviation from the plane of the shell).

Domes are usually in a shape of a geodesic dome. Domes with a compact structure were realized only occasionally and for small spans. Usual accomplishment of the dome is with a continuous-reinforced structure (with radial ribs) or net structure. Domes with net structure are more popular than domes with compact structure due to easier execution of double-curved surfaces with lines and spatial joints. Examples of dome types with net structure are shown in Fig. 12.3.

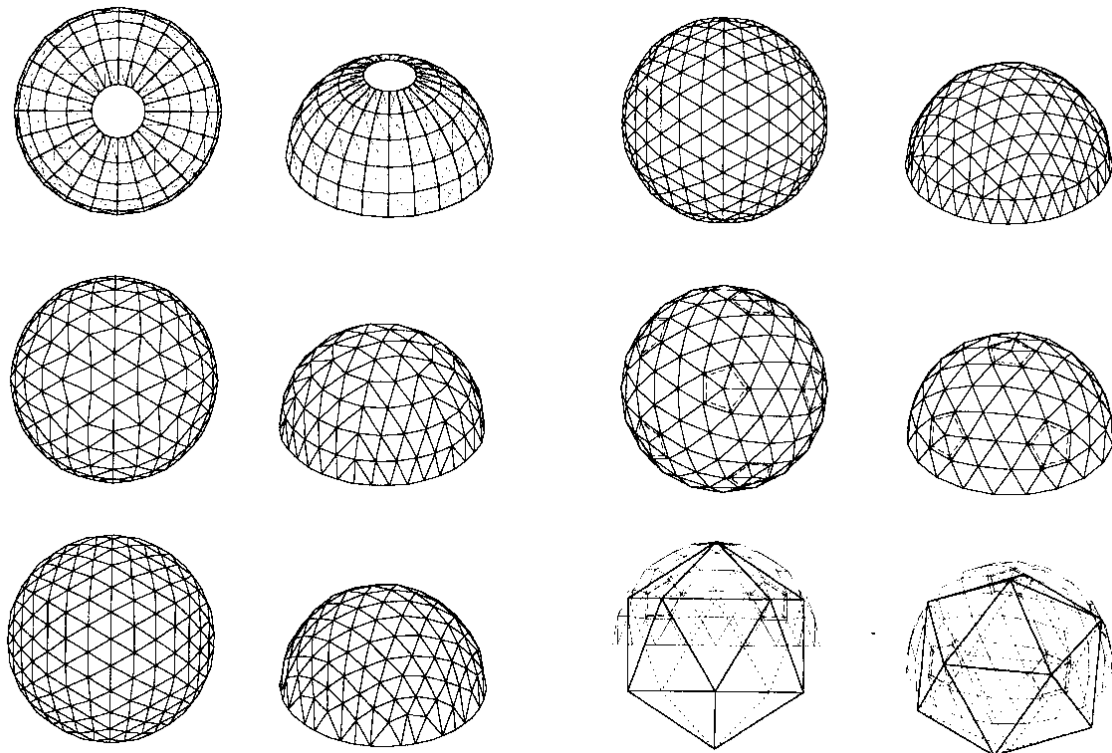

Fig. 12.3 Types of domes with net structure:
top left – radial rib dome, left centre – triangular dome,
left bottom – hexagonal dome, top right – ensphere dome,
right centre – geodesic dome, right bottom – geodesic derivation.

An example of a sports hall dome with bearing radial ribs is shown in Fig. 12.4. The dome span is 105 m, the camber of 18.5 m, the radius of curvature of the central line is 85 m. The hall was built in Žilina (Slovakia) in 1982. The load bearing system consists of 44 semiarches made of glue laminated timber. The arches are anchored into the foundation reinforced concrete vault impostes, which are mutually connected by a footing circumferential ring. At the peak, the arches are connected to a steel lantern opening with a diameter of 5 m. The depth of section of the arch made of glue laminated timber is variable (800 to 1900 mm) and the width is constant – 240 mm. Lamellas of thickness of 32 mm are glued together with FR-63 glue.



Fig. 12.4 Dome of a sports hall in Žilina (Slovakia)

Figures 12.5 and 12.6 show a dome of the sports hall roofing – Tacoma Dome in the USA with a span of 160 m. The hall was opened in 1983, and it is one of the largest timber halls in the world as far as the span is concerned. The geometrical system of a dome represents a combination of the hexagonal and triangular domes. The bearing system of the dome consists of a net of trusses of glue laminated timber. The outermost ring of the triangular dome is used to avoid the irregular edge of the hexagonal dome. All other inner rings are formed as hexagonal domes with ribs, which are parallel in three axes. The primary members of glued Douglas fir are 170-220 mm wide x 750 mm deep. The connections utilize steel boards and screws. The sheathing is Douglas fir tongue-and-groove planks 50 mm thick. A pre-stressed concrete ring beam acts as a support. To erect the roof two months were sufficient.



Fig. 12.5 Tacoma Dome in USA (source: Internet)



Fig. 12.6 The bearing structure of Tacoma Dome in USA (source: Internet)

4.3.4 Translation shell surfaces – suspension shell structures

Suspension shell structures are a curious type of shells, which are primarily strained by tension in its plane. Due to the shape stabilization, mainly against wind suction and acquiring necessary pre-stress, the shells should be curved in two directions. In timber these shells appear as structures continuously reinforced – by ribs.

An example of such suspension shell structures is the roofing of EXPO 2000 in Hannover (Fig. 12.7). The enormous freestanding covering consists of square canopies, each covering an area of 39 x 39 m consisting of consoles and continuously reinforced shells located on a column/tower 18 m high. The columns consist of 4 parts and of conical section. When designing the roofing, it was necessary to take into consideration asymmetric snow loads and wind pressure.



Fig. 12.7 Pavilion covering - EXPO 2000 in Hannover (source: Internet)



Another example is the roofing on the Church of the Immaculate Conception in Prague-Strašnice (Fig. 12.8). The timber structure of the church features a shape resembling a quadrilateral pyramid placed on a reinforced concrete square base (30 x 30 m). The pyramid is 23.5 m high. The main supporting structure comprises corner ties with a centre column of glue-laminated wood. The joints are designed in steel plates and pins. The roofing is made of timber shell in a shape of a hyperbolic paraboloid. The shell consists of four layers of crossing lamellas. The lowest two layers have spaces and create the ceiling. All layers with total thickness of 68 mm are connected by nails and mutually glued on the shell edge. The shell structure design was prepared using the membrane theory without the use of computer technology.

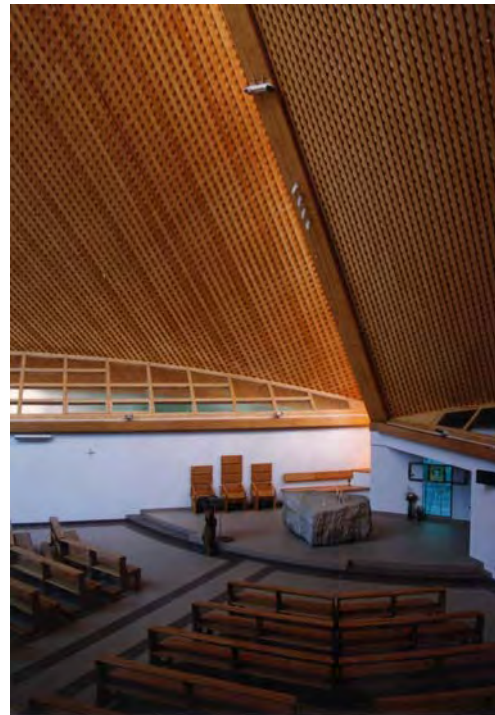

Fig. 12.8 Church of Immaculate Conception in Prague-Strašnice

5 Conclusion

Spatial timber structures of roofing form a large and varied group of structures that can comply with the demands of architects and project engineers regarding the roofing of actually any structure. Moreover, it nearly always concerns original and aesthetically impressive structures.



6 References

- [1] Herzog, T. et. al.;
“Timber Construction Manual”,
Birkhäuser – Publisher for Architecture, Basel, ISBN 3-7643-7025-4, 2004
- [2] Müller, Ch.;
“Laminated Timber Construction”,
Birkhäuser – Publisher for Architecture, Basel, ISBN 3-7643-6267-7, 2000
- [3] Straka, B., Pechalová, J.;
“Timber Structures”,
CERM s.r.o., Brno, ISBN 80-7204-017-0, 1996 (in Czech)
- [4] Kuklík, P.;
“Timber Structures 1”,
Nakladatelství ČVUT, Praha, ISBN 978-80-01-03614-3, 2007
- [5] Hrčka, I. a kol.;
“Design of Timber Structures”,
ES TU Zvolen, ISBN 80-228-0332-4, 1994 (in Slovak)

Chapter No. 12 has been prepared by Alois MATERNA and Antonín LOKAJ, Faculty of Civil Engineering, Technical University of Ostrava / Czech Republic.



TIMBER FRAME HOUSES

1 Introduction

Nowadays, there are the strongest arguments for building timber frame buildings. Brand new and improved features, being introduced in the early 80s in the last century, brought about the expansion of timber frame buildings all over the world. The most important are the next introduced changes:

- transition from on-site construction to prefabrication in factory,
- transition from elementary measures to modular building,
- bigger input of glued-laminated wood in construction,
- development from micro-panel wall system to macro-panel wall prefabricated panel system.

Nevertheless, it was clear to competitive fields of building that today's timber frame building is extremely high valued and it is capable of fulfilling all the demands from society and the environment that we live in. There are many arguments for timber frame homes, let me count the most important:

- very good building physical properties,
- built-in materials show environmental excellence,
- lower energy consumption while preparing built-in materials,
- the speed of the build,
- and, as one of the most important, good seismic security.

First, building physical properties are the most important. Not only because in the well insulated object energy for heating is saved, which is environmentally friendly, but also homeowners have an extremely positive feeling about living in such houses. What is more, the people who lived in masonry houses would also agree with them.

Actually, the wood or gypsum treatment as the most used materials in such homes use less energy to produce than bricks or concrete or some other prefabricated products.



Another reason for this kind of building is speed of build because of the high degree of prefabrication of elements in a factory; the buildings are built in an essentially shorter period of time. This means that in the building phase, a minimum of time is spent in inclement weather conditions. Also, the probability of later claims is lowered. Another argument for building timber framed is that with the same outer dimensions, we get up to 10% more residential area. As mentioned above, lower maintenance costs, high thermal efficiency and lower probability of constructional failure makes it easier for investors to choose this option.

Previous research has established that timber framed test houses exposed to earthquakes showed very good seismic efficiency. The reason lies in their quite low weight and the ductile behaviour of timber and joints.

Nowadays, timber frame building is expanding all over the world. In comparison, there are values in percentage of new erected timber frame residential objects in different parts of the world: Canada 95 %, USA 65 %, Japan 50 %, Scandinavia 70 %, Great Britain 10 % (Scotland 50 %), Germany 7 % (Bavaria 30 %), Austria 8 %, Czech Republic 2 % and South Europe up to 3%. Given these facts, it is clear that there are great differences in expansion of timber frame construction worldwide. There are two systems of timber frame homes:

- Post and beam systems,
- Timber frame panel systems.

In Section 2 a short overview about the two most frequently used frame building systems is presented. Section 3 describes main bearing capacity elements in the timber frame panel building system. Approximate design models for floor and wall bearing timber elements are given in Section 4. For taller timber frame buildings, subjected to heavy horizontal forces, it is sometimes necessary to reinforce the walls. Some strengthening possibilities are briefly presented in Section 5. Some important details of connections are briefly described and schematically shown in Section 6.

2 Timber frame Building Systems

There are two commonly used timber frame systems around the world:

- Post and beam system
- Timber frame panel system

2.1 Post and beam system

In North America, classical, mostly non-assembly types are dominant where the main load bearing part of the construction presents a frame composed of beams and pillars, which are continuously constructed from the bottom to the roof (Fig. 13.1). Because of the limited height of pillars (maximum approx. 8 – 10 metres), the above mentioned type is suitable for one or two-floor units.



Fig. 13.1 Post and beam building system

2.2 Timber frame panel systems

In this system, the basic vertical load bearing elements are panel walls that consist of load bearing timber frame and sheathing boards, while horizontal floor load bearing elements are slabs constructed of roof beams and load bearing wood-based sheathing boards on the upper side of the roof beams. Because all elements are prefabricated, the erection is very fast so the slogan “two men building one house“ would be suitable. Consequently, the system is very useful for multi-storey building; therefore the interest in this system in the world is growing.

The construction performs systematic floor-by-floor building; after the walls are constructed the floor platform for the next level is built, as it is schematically presented in Fig. 13.2a. Consequently, this system is very useful for multistorey buildings.

Dependent on the dimensions of walls, we distinguish between micro-panel and macro-panel wall-systems. For example, the structure of the 6-storey timber frame building with overall groundplan dimensions of 38 m x 18.60 m, built with the macro-panel wall building system, is presented in Fig. 13.2b. The first two levels of the Hotel Dobrava building on Pohorje mountain in Slovenia are classical - made from reinforced concrete, while the upper four consist of the prefabricated timber frame elements, in the details described in Sections 3 and 4. More details about the aforementioned building can be found in Premrov [1].

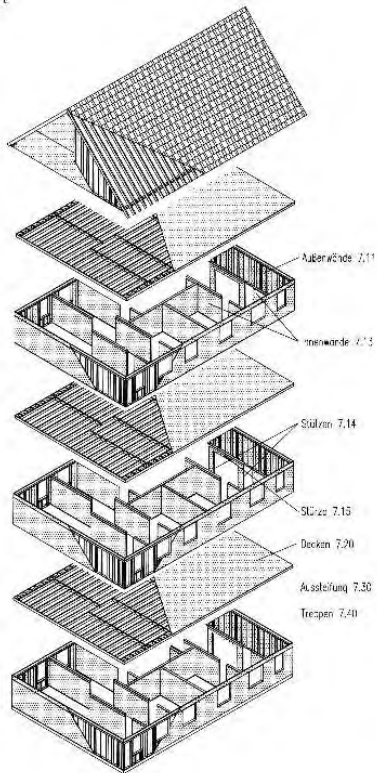

a. Schematic presentation of the timber frame panel construction

b. 6-storey timber frame panel building (Hotel Dobrava, Pohorje mountain, Slovenia)

Fig. 13.2 Timber frame panel construction and example of a building erected with this system

2.2.1 Micro-Panel Wall System

In this system, a wall element usually consists of three timber studs with the overall wall width of 100 – 130 cm. The system will be described in detail in Section 3.

2.2.2 Macro-panel Wall System

The Macro-panel System was developed from the micro-panel system in the last decade and represents an important milestone in panel timber frame building. The aim of the system is that whole wall assemblies, including windows and doors, are totally constructed in a horizontal plane in a factory (Fig 13.3a) from where there are transported to a building-site (Fig 13.3b). Consequently, because there is practically no need for horizontal connections between wall elements, the houses are built in a substantial shorter period of time compared with the Micro-Panel System. The aforementioned system is widely used, especially in Central Europe.



a. Factory manufacturing of pre-fabricated walls

b. Mounting of walls on the building-site

Fig. 13.3 Manufacturing and mounting of walls

3 Description of main bearing capacity elements

3.1 Prefabricated floor elements

Prefabricated micro-panel floor elements of a width of 1000 to 1300 mm usually consist of three timber beams with dimensions between 80 and 220 mm. Usually they are covered with a wood-based sheathing board (plywood, particleboard, OSB, etc.) at the top and with a fibre-plaster board (FPB), usually of typical thickness of 15 mm at the bottom (Fig. 13.4).

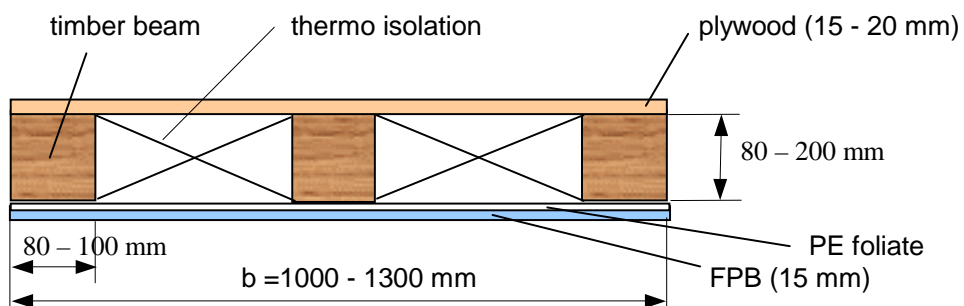

Fig. 13.4 Composition of the prefabricated micro-panel floor element

3.2 Prefabricated wall elements

Prefabricated timber walls as main vertical bearing capacity elements, usually with typical dimensions with a width $b = 1250$ mm and a height $h = 2500 - 2600$ mm, are composed of a timber frame and of sheets of board-material fixed by mechanical fasteners to both sides of the timber frame (Fig. 13.5). There are many types of panel sheet products available such as wood-based materials (plywood, oriented strand board, hardboard, particleboard, etc.) or plaster and gypsum plasterboards (GPB). These elements were originally started in Germany and recently most frequently used in Central Europe. Between the timber studs and girders, a thermal insulation material is inserted, whose thickness depends of the type of the wall (internal or external). The sheathing boards on the both sides of the wall can be covered with a 12.5 mm gypsum-cardboard cladding.

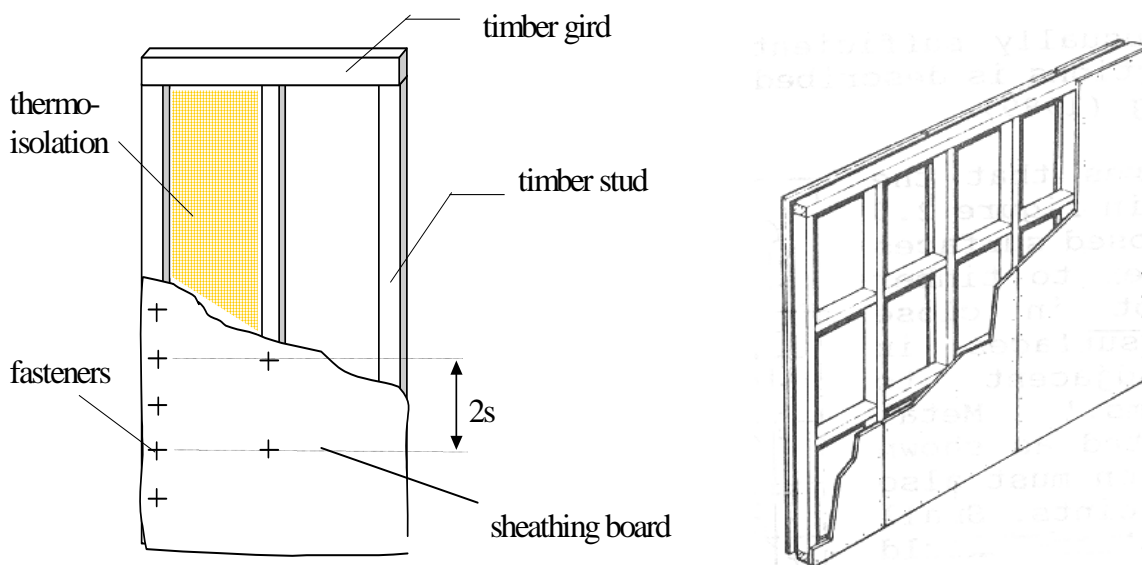

Fig. 13.5 Composition of the wall element

3.3 Prefabricated roof elements

Roofs can be constructed in a classical style using roof beams whose dimensions and position depends on snow and wind loads acting on a roof. They are covered on both sides with wood-based boards. Thermal insulation is inserted between the beams. However, in the previous number of years, prefabricated roof elements including all above mentioned roof elements have been widely used (Fig. 13.6).



a. Prefabricated roof beams with boards



b. Prefabricated apex elements

Fig. 13.6 Prefabricated roof elements

4 Design models

4.1 Design models for the floor elements

In a static design for the floor elements, the continuous beam system with a vertical dead and live load is usually used (Fig. 13.7). For the floor in apartment buildings, a value of $p = 2 \text{ kN/m}^2$ is prescribed for the live load in Eurocode 1 [2], while the value of dead load (g) usually varies between 1.2 kN/m^2 and 1.8 kN/m^2 . The position of walls can usually be approximated with vertical rigid supports.

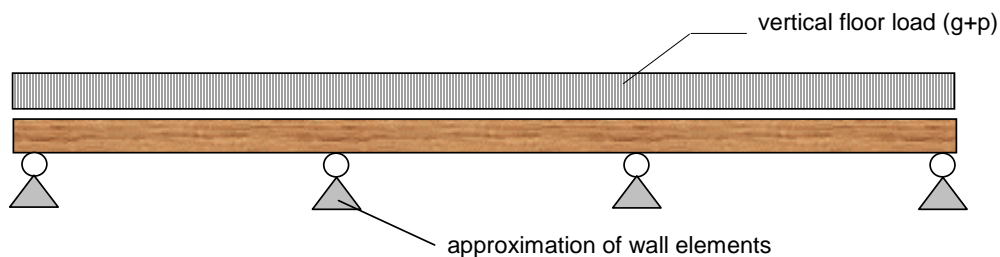

Fig. 13.7 A simplified static design of the prefabricated floor elements

4.2 Design for the wall elements

Vertical load (dead load, live load, snow, etc.) impact is calculated with axial compression ($N_g + N_p + N_s$) parallel to the grain of the timber studs. Horizontal force distribution on walls is calculated according to the shear stiffness ratio between the walls. For a wall assembly in one principal direction, comprised of one or more walls, the simplified static design presented in Fig. 13.8 can be used to calculate the axial forces, shear forces and bending moment due to vertical and horizontal loads.

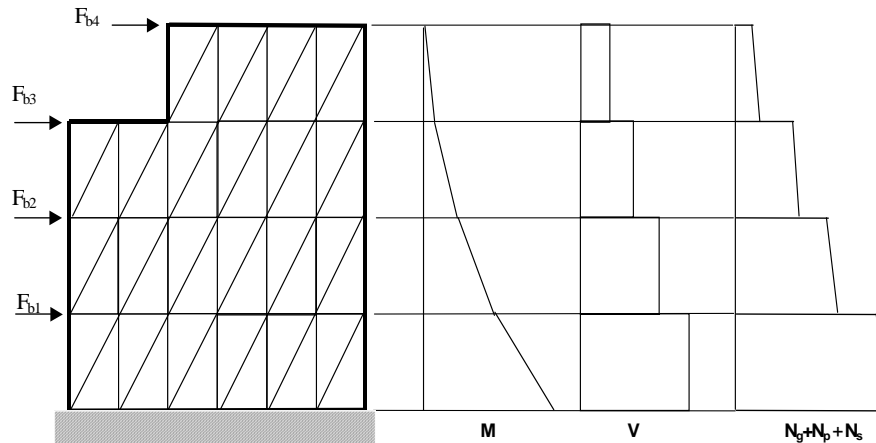

Fig. 13.8 Static design of the prefabricated wall elements in one principal direction

Load distribution on separate walls in one level is calculated according to the static design in Fig. 13.9. It is important to note that Eurocode 5 [3] declared that wall panels which contain a door or window opening should not be considered to contribute to the racking (horizontal) load-carrying capacity (Method A), or at least, the lengths of panel on each side of the opening should be considered as separate panels (Method B).

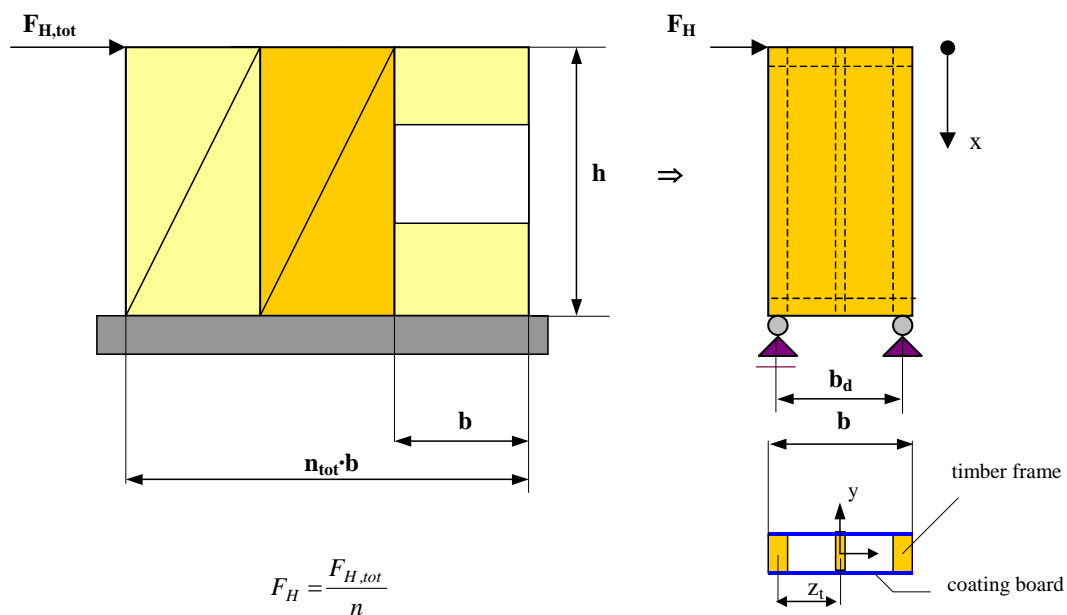

Fig. 13.9 Static design for the wall system in one level

In structural analysis panel walls for design purposes can be regarded separately as vertical cantilever beams with the horizontal force ($F_H = F_{H,tot} / n$) acting at the top (Fig. 13.8), Eurocode 5 [3], Faherty and Williamson [4], Hoyle and Woeste [5]. Considered supports approximate an influence of neighbouring panel walls and assure an elastic-clamped boundary condition for the treated wall.



Many design models have been proposed in order to analyse and predict the behaviour of wood-based shear walls and diaphragms subjected to lateral loads. Two simplified computational methods are given in the final draft of Eurocode 5 [3] in order to determine the load-carrying capacity of the wall diaphragm.

The first – **Method A**, is identical to the “Lower bound plastic method”, presented by Källsner and Lam [5], based on the following key assumptions:

- behaviour of the joints between the sheet and the frame members is assumed to be linear-elastic until failure,
- the frame members and the sheets are assumed to be rigid and hinged to each other.

It should be provided that:

- the spacing of fasteners (s) is constant along the perimeter of every coating board (sheet),
- the width (b) of each sheet is at least $h/4$.

For a wall assembly made up of several wall elements the design racking load-carrying capacity of a whole wall assembly should be calculated from

$$F_{v,Rd} = \sum F_{i,v,Rd} \quad (13.1)$$

where $F_{i,v,Rd}$ is the design racking load-carrying capacity of the wall element (panel) obtained as a sum of all the fasteners’ shear resistances ($F_{f,Rd}$) along the loaded edges in a form of:

$$F_{i,v,Rd} = \sum F_{f,Rd} \cdot \frac{b}{s} \cdot c \quad (13.2)$$

$$c = \begin{cases} 1 & \text{for } b \geq b_0 \\ \frac{b}{b_0} & \text{for } b \leq b_0 \end{cases} \quad \text{where } b_0 = h/2 \quad (13.3)$$

In order that the centre stud may be considered to constitute a support for a sheet, the spacing of fasteners in the centre stud should not be greater than twice the spacing of the fasteners along the edges of the sheet (Fig. 13.5).



For wall panels with sheets on both sides, the following rules apply:

- if the sheets and fasteners are of the same type and dimension then the total racking load-carrying capacity of the wall should be taken as the sum of the racking load-carrying capacities of the individual sides,
- if different types of sheets are used, 75 % of the racking load-carrying capacity of the weaker side may, unless some other value is shown to be valid, be taken into consideration if fasteners with similar slip moduli are used. In other cases not more than 50 % should be taken into consideration.

When tensile forces are transmitted to the construction situated below, the panel should be anchored by stiff fasteners. Buckling of wall studs should be checked in accordance with 6.3.2. of Eurocode 5 [3]. Where the ends of vertical members bear on horizontal framing members, the compression perpendicular to the grain stresses in the horizontal members should be assessed according to 6.1.5 of Eurocode 5 [3]. Shear buckling of the sheet may be disregarded, provided that $b_{net} / t \leq 100$ where b_{net} is the clear distance between studs and t is the thickness of the sheet.

The second simplified shear model, prescribed in **Method B**, is applicable to walls made from sheets of wood-based panel products only, fastened to a timber frame. The fastening of the sheets to the timber frame should either be by nails or screws, and the fasteners should be equally spaced around the perimeter of the sheet. The width of the wall panel (b) should be at least the panel height (h) divided by 4. The whole resistance of the wall assembly ($F_{v,Rd}$) is computed by Eq. (13.1) with an important distinction that according to Method A the sheathing material factor (k_n), the fastener spacing factor (k_s), the vertical load factor ($k_{i,q}$) and the dimension factor for the panel (k_d) are included in the design procedure in the form of:

$$F_{i,v,Rd} = \sum F_{f,Rd} \cdot \frac{b}{s_0} \cdot c \cdot k_d \cdot k_{i,q} \cdot k_s \cdot k_n \quad (13.4)$$

where

$$s_0 = \frac{9700 \cdot d}{\rho_k} \quad (13.5)$$

d fastener diameter in mm,

ρ_k characteristic density of the timber frame in kg/m³.



$$k_d = \begin{cases} \frac{b_1}{h} & \text{for } \frac{b_1}{h} \leq 1,0 & \text{(a)} \\ \left(\frac{b_1}{h}\right)^{0,4} & \text{for } \frac{b_1}{h} > 1,0 \text{ and } b_1 \leq 4,8 \text{ m} & \text{(b)} \\ \left(\frac{4,8}{h}\right)^{0,4} & \text{for } \frac{b_1}{h} > 1,0 \text{ and } b_1 > 4,8 \text{ m} & \text{(c)} \end{cases} \quad (13.6)$$

$$k_{i,q} = 1 + \left(0,083 q_i - 0,0008 q_i^2\right) \left(\frac{2,4}{b_1}\right)^{0,4} \quad (13.7)$$

where q_i is the equivalent uniformly distributed vertical load acting on the wall (kN/m) and should be determined using only permanent actions and any net effects of wind together with the equivalent actions arising from concentrated forces, including anchorage forces, acting on the panel. For the purposes of calculating concentrated vertical forces they should be converted into an equivalent uniformly distributed load on the assumption that the wall is a rigid body e.g. for the load $F_{i,vert,Ed}$ acting on the wall as shown in Fig. 13.10.

$$q_i = \frac{2 a F_{i,vert,Ed}}{b_1^2} \quad (13.8)$$

where:

a is the horizontal distance from the force F to the leeward corner of the wall,

b is the length of the wall.

The fastener spacing factor (k_s) is computed in a form of:

$$k_s = \frac{1}{0,86 \frac{s}{s_0} + 0,57} \quad (13.9)$$

where s is the spacing of the fasteners around the perimeter of the sheets (Fig. 13.5).

The sheathing material factor (k_n) is in a form of:

$$k_n = \begin{cases} 1,0 & \text{for sheathing on one side} & \text{(a)} \\ \frac{F_{i,v,Rd,max} + 0,5 F_{i,v,Rd,min}}{F_{i,v,Rd,max}} & \text{for sheathing on both sides} & \text{(b)} \end{cases} \quad (13.10)$$

where:

$F_{i,v,Rd,max}$ is the design racking strength of the stronger sheathing,

$F_{i,v,Rd,min}$ is the design racking strength of the weaker sheathing.

The external forces $F_{i,c,Ed}$ and $F_{i,t,Ed}$ (Fig. 13.10) from the horizontal action $F_{i,v,Ed}$ on wall i should be determined from

$$F_{i,c,Ed} = F_{i,t,Ed} = \frac{F_{i,v,Ed} h}{b_i} \quad (13.11)$$

These external forces can be transmitted to either the adjacent panel through the vertical panel-to-panel connection or to the construction above or below the wall as it is presented in Section 6. When tensile forces ($F_{i,t,Ed}$) are transmitted to the construction below, the panel should be anchored with stiff fasteners.

The board's thickness (t) is defined according to the tensile diagonal force (T), the corresponding effective width (b_{eff}) and to the tensile strength of the sheathing material ($f_{t,d}^{(b)}$). According to Fig. 13.10 the designed tensile force (T_d) is calculated in the form of:

$$T_d = \frac{F_{Hd,1}}{\cos \alpha} \quad (13.12)$$

where:

$F_{Hd,1}$ is the horizontal force acting on one board. The board thickness (t) is then defined in the form:

$$t \geq \frac{T_d}{b_{eff} \cdot f_{t,d}^{(b)}} \quad (13.13)$$

For b_{eff} the value of 500 mm is usually recommended for practical use.

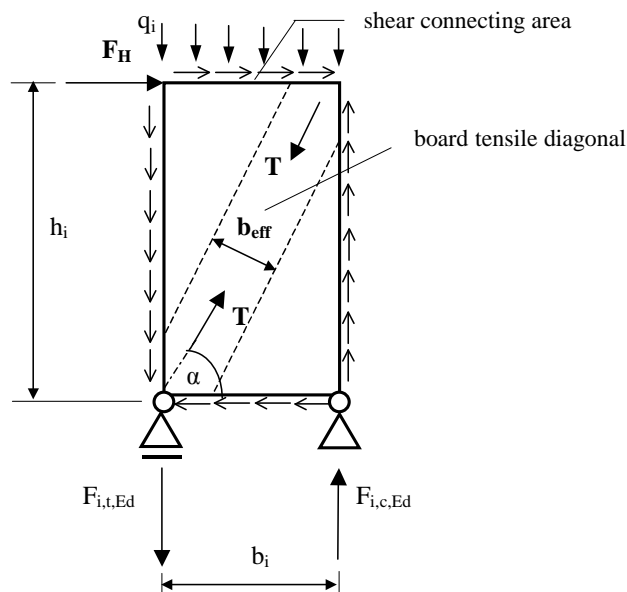

Fig. 13.10 Considered force distribution

Sometimes it is convenient to control a maximal horizontal deflection at the top of the wall. A simplified formula considering cantilever-bending deflection (w_t), shear deflection of the wood-based sheathing boards (w_b), flexibility of timber-sheathing connections (w_c) and deflection due to anchorage details (w_a) can be found in [4] or [5]:

$$w = w_t + w_b + w_c + w_a = \frac{8 \cdot F_H \cdot h^3}{E_t \cdot A_t \cdot b} + \frac{F_H \cdot h}{G_b \cdot t} + 0.376 \cdot h \cdot e_n + d_a \quad (13.14)$$

where:

- E_t elastic modulus of timber elements,
- A_t area of boundary vertical timber element cross section,
- G_b modulus of rigidity of coating boards,
- t effective thickness of coating boards,
- e_n nail deformation.

All the above mentioned Eurocode methods are usually unsuitable for the walls sheathed with fibre-plaster boards (FPB), widely used specially in the Central Europe. The main assumptions do not exactly coincide with the real state of FPB, in which the tensile strength is evidently lower than the compressive strength. Consequently, cracks in a tensile zone usually appear under heavy horizontal loads before stresses on the fasteners reach their yielding point, and the fibreboards do not behave usually as rigid elements (Dobrila and Premrov [7]). However, by employing FPB as a coating material, a horizontal load shifts a part of the force over the mechanical fasteners to the fibreboard and the wall acts like a deep beam [4], [7]. Distribution of the horizontal force by composite treatment of the element depends on the proportion of stiffness. The effective bending stiffness $(EI_y)_{eff}$ of mechanically jointed beams which empirically considers the flexibility of fasteners via coefficient γ_y , taken from Eurocode 5 [3], can be written in the form of:

$$(EI_y)_{eff} = \sum_{i=1}^n E_i \cdot (I_{yi} + \gamma_i \cdot A_i \cdot a_i^2) = \sum_{i=1}^{n_{timber}} (E_i \cdot I_{yi} + E_i \cdot \gamma_i \cdot A_i \cdot a_i^2)_{timber} + \sum_{j=1}^{n_{board}} (E_j \cdot I_{yj})_{board} \quad (13.15)$$

where n is the total number of elements in the considered cross-section and a_i is a distance between global y-axis of the whole cross-section and local y_i -axis of the i -th element with a cross-section A_i (Fig. 13.8). It is evident that the force distribution in this case strongly depends on the stiffness coefficient of the connecting area (γ_y), which mostly depends on the fasteners slip modulus (K_{ser}) and fasteners disposition, as well as on the type of the connection. Experimental studies were conducted on the structural behaviour of wood-based diaphragms, on system components such as connections (Chou and Polensek [8], Polensek and Bastendorff [9]) and on the spacing of fasteners (Van Wyk [10], Kuhta and Premrov [11]). Semi-analytical design models considering composite behaviour of the timber frame and the sheathing boards are developed in Premrov, Dobrila and Bedenik [12]. The models enable simultaneously to consider the influence of inserted steel diagonals, flexibility of mechanical fasteners between the boards and the timber frame and any appearing cracks in the tensile area of the fibre-plaster boards.



Analytical design models were also developed to predict the dynamic response of the timber shear walls, Stewart [13], Dolan [14]. Finally, Kasal et al. [15] developed a three-dimensional finite element model to investigate the responses of complete light-frame wood structures.

The test method for the treated timber framed walls is prescribed in EN 594 [16], but it is almost a compromise and not obvious in all details, though there is a fundamental difference in the Eurocode design and test methods, namely in the way of vertical anchoring of the stud to the tension side of the wall unit.

5 Strengthening of the fibre-plaster sheathing boards

As mentioned above, the timber framed walls with fibre-plaster sheathing boards (FPB) can be treated as composite elements. Distribution of the horizontal force by a composite treatment of the element depends on the proportion of the stiffness. Because the tensile strength of FPB is approximately 10-times lower than the compressive strength, and evidently smaller than the wood strength of all members in the timber frame, the FPB are usually the weaker part of the presented composite system. Thus, especially in multi-level buildings located in seismic or windy areas, cracks in FPB usually appear. In these cases the FPB lose their stiffness and therefore their resistance should not be considered at all. Stresses in the timber frame under a horizontal load are usually not critical.

There are several possibilities to reinforce panel walls in order to avoid cracks in FPB:

- by using additional boards. The boards are usually doubled:
 - symmetrically (on both sides of a timber frame),
 - non-symmetrically (on one side of a timber frame),
- by reinforcing boards with steel diagonals,
- by reinforcing boards with carbon or high-strength synthetic fibres (FRP, CFRP, etc.).

In Dobrila and Premrov [7] experimental results using **additional FPB** are presented. The test samples demonstrated higher elasticity, whilst bearing capacity and especially ductility were not improved in the desired range.

With the intention to improve the resistance and especially the ductility of the walls it is therefore more convenient to insert classical diagonal steel strips, which have to be fixed to the timber frame. In this case only a part of the horizontal force is shifted from boards over the tensile steel diagonal to the timber frame after the appearance of the first crack in the tensile zone of FPB. It is evident from the relationship between the measured forces forming the first crack that the inserted steel diagonals are not very important. But the proportion between the measured destruction forces shows that the resistance of the reinforced panels increases by 77% and ductility for 39%, [7].

The third solution – using **CFRP strips**, which are glued in the tensile diagonal direction to the FPB, Fig. 13.11. This strengthening concept is applied in the way that the composites would contribute to tensile capacity when the tensile strength of FPB is exceeded. Experimental results presented in Premrov, Dobrila and Bedenik [17] demonstrated some important facts, which were considered by the presented modelling of the wall elements (Premrov and Dobrila [18]): a) Force forming the first crack in FPB essentially increased in all kinds of the test samples; b) The inclusion of CFRP diagonal strip reinforcement on the load-carrying capacity appeared to be quite high; c) The test samples proved an important distinction in behaviour in timber frame-fibreboard connecting area depending on the boundary conditions between the inserted CFRP strips and the timber frame. If the strips were additionally glued to the timber frame the fasteners would produce substantially smaller slip in the connecting area, which never exceeded 1mm when the first tensile cracks in FPB appeared. Therefore it can be assumed that the yield point of the fasteners was not achieved before cracks appeared in any way and the elements tend to fail because of cracks appearing in FPB. On the other hand, in the case where the CFRP diagonals were unconnected to the timber frame, the slip between the FPB and the timber frame was evidently higher and the walls tend to fail because of fastener yielding.



Fig. 13.11 Experimental test on diagonally CFRP reinforced test sample [17], rotation for 90°

6 Connections

6.1 Vertical connection between wall elements

Vertical connection between the wall elements is presented in Fig. 13.12. Connection of the upper wall element to the floor beam is made with BMF angle fittings using spiral nails. The floor beam is connected to the lower wall element with one additional BMF spiral nail.

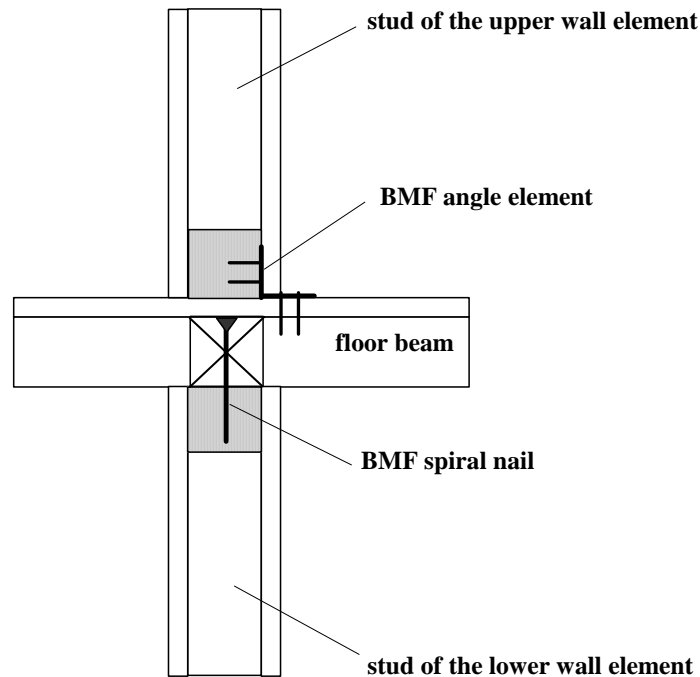

Fig. 13.12 Vertical connection between the wall elements

6.2 Connection of the lowest timber wall element with the concrete base

b.) Connection of the lowest timber wall element to the concrete base is usually made with special steel plates and two bolts as it is schematically shown in Fig. 13.13. The scheme additionally presents a possibility of connection of the steel diagonal to the timber frame (reinforcing possibility described in Section 5).

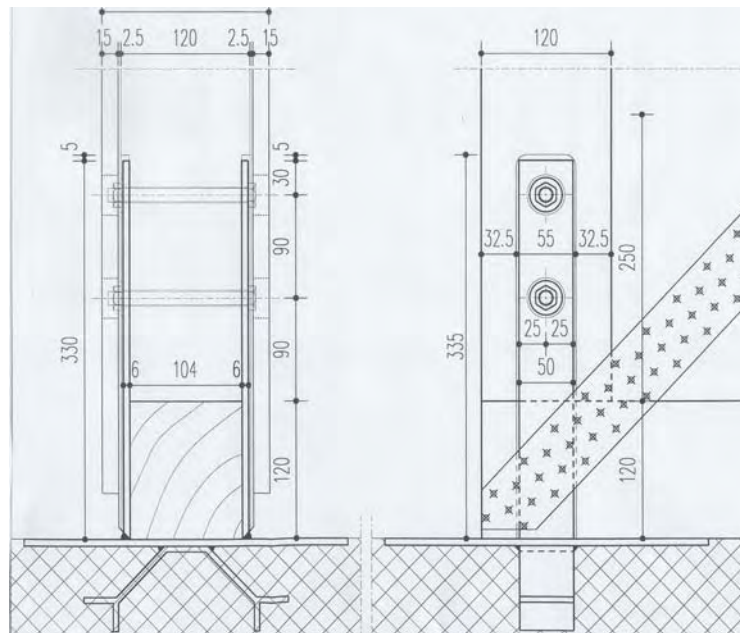

Fig. 13.13 Connection of the wall element reinforced with BMF diagonal to the concrete base

7 References

- [1] Premrov, M.;
“Terme Zreče, Hotel Dobrava”,
Case study no. 8, Educational materials for designing and testing of timber structures – TEMIS, Case studies, Instruction handbook. Ostrava: VŠB-TU, Fakulta stavební, 2007, http://fast10.vsb.cz/temtis/documents/Instruction_8_Dobrava.pdf
- [2] CEN/TC 250;
“Eurocode 1: Actions on structures – Part 1-1: General actions – Densities, self-weight, imposed loads for buildings”,
Brussels, 2002
- [3] CEN/TC 250/SC5 N173;
“Eurocode 5: Design of Timber Structures, Part 1-1 General rules and rules for buildings”,
Final draft prEN 1995-1-1; Brussels, 2004
- [4] Faherty, K.F., Williamson, T.G.;
“Wood Engineering and Construction Handbook”,
Mc Graw-Hill Publishing Company; 1989
- [5] Hoyle, R.J., Woeste, F.E.;
“Wood Technology in the Design of Structures”,
Iowa State University Press, Ames, Iowa, 1989



- [6] Källsner, B., Lam F.;
“Diaphragms and shear walls”,
Holzbauwerke: Grundlagen, Entwicklungen, Ergänzungen nach Eurocode 5. Step 3,
pp. 15/1-17, Fachverlag Holz; Düsseldorf, 1995
- [7] Dobrila P., Premrov M.;
“Reinforcing methods for composite timber frame-fiberboard wall panels”,
Engineering Structures 25(11), pp. 1369-1376, 2003
- [8] Chou, C., Polensek, A.;
“Damping and stiffness of nailed joints: response to drying”,
Wood and Fiber Science 19(1), pp. 48-58, 1987
- [9] Polensek, A., Bastendorf, K.M.;
“Damping in nailed joints of light-frame wood buildings”,
Wood and Fiber Science 19(2), pp. 110-125; 1987
- [10] Van Wyk, W.J.;
“The strength, stiffness and durability of glued, nail-glued and screw-glued timber
joints”,
South African Forestry Journal 138, pp. 41-44; 1986
- [11] Kuhta, M., Premrov, M.;
“Influence of Fasteners Disposition on Behaviour of Timber-Framed Walls with
Double Fibre-Plaster Coating Boards”,
American Journal of Applied Sciences, in press, 2007
- [12] Premrov, M., Dobrila, P., Bedenik, B.S.;
“Approximate analytical solutions for diagonal reinforced timber framed walls with
fibre-plaster coating material”,
Constr. build. mater. 18 (10), pp. 727-735; 2004
- [13] Stewart, W.G.;
“The seismic design of plywood sheathed shearwalls”,
Thesis submitted in partial fulfilment of a Ph. D. degree, University of Canterbury;
New Zealand, 1987
- [14] Dolan, J.D., Foschi, R.O.;
“A numerical model to predict the dynamic response of timber shear walls”,
Proceedings of the International Timber Engineering Conference; London, 1991.
- [15] Kasal, B., Leichti, R.J., Itani, R.Y.;
“Nonlinear finite-element model of complete light-frame wood structures”,
J. Struct. Engrg. ASCE 120(1), pp. 100-119, 1994
- [16] European Committee for Standardization;
“EN 594: Timber structures – Test methods – Racking strength and stiffness of timber
frame wall panels”,
Brussels, 1995



- [17] Premrov, M., Dobrila, P., Bedenik, B.S.;
“Analysis of timber framed walls coated with CFRP strips strengthened fibre-plaster boards”,
International Journal of Solids and Structures 41 (24/25), pp. 7035–7048, 2004
- [18] Premrov, M., Dobrila, P.;
“Modelling of Fastener Flexibility in CFRP Strengthened Timber framed Walls Using Modified γ – Method”,
Engineering Structures, in press

Chapter No. 13 has been prepared by Miroslav PREMROV, Faculty of Civil Engineering, University of Maribor / Slovenia.



BRACING OF TIMBER BUILDINGS

1 Introduction

Structural systems must be designed to transfer external loads caused by wind, accidental and seismic loads, braking forces from cranes, etc., to the foundations

The systems may also be able to balance internal forces caused by deviations of the main structural elements from their intended positions. Examples are fixing of members out of plumb or fixing of elements in compression.

There are reports from many countries, where severe problems with mistakes in the bracing of buildings have been observed. It is important that the designer has an overview of and can account for the transfer of forces from the points where the loads are applied and down to the foundation.

This chapter will concentrate on systems for simple buildings. In the literature like Timber Construction Manual [1], more detailed descriptions are given of different ways to brace timber buildings.

In practice, the principal check of the bracing in buildings with rectangular plans are often divided in 1) transverse loads and 2) longitudinal loads, but it is important to know that there are forces in both directions at the same time.

2 The typical bracing elements

2.1 The typical vertical elements

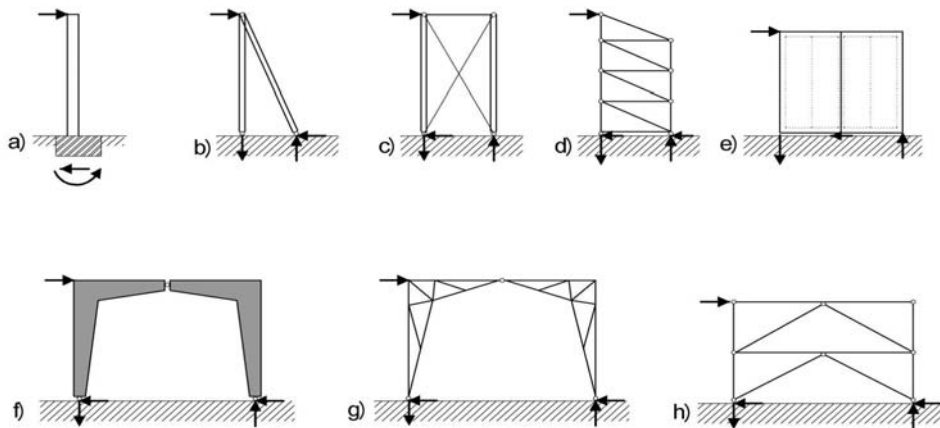

Fig. 14.1 The typical vertical bracing elements

Fig. 14.1 shows typical vertical elements as: a) cantilever with fixed support, b) diagonal support, c) truss cross diagonal support, d) truss bracing, e) wall diaphragms, f) frames, g) truss frames, h) K- truss

— The cantilever (a)

has a fixed support to the foundation or the underlying structure. It can be fixed by, for example, connections of glued-in bolts or nailed or bolted plates of steel. The horizontal deflection of the cantilever may cause problems if it leads to cracks in internal walls. An advantage of the system is that it gives a lot of free area without walls.

— The diagonal support (b)

is a simple way to transfer the forces to the supports through normal forces in the members. The diagonal members can be in either compression or in tension. Compression will normally result in a big cross section because of buckling of the member.

— The cross diagonal support (c)

will only use one diagonal, when it is in tension. The member with compression will have no force, because it is bending out. It is “falling out”. The diagonals can then have a small cross section. This system is used in many buildings. Often the diagonals are tightened. This will reduce the deflections and the problems with “hanging” diagonals.

- The truss bracing (d)

can give a reduction in material consumption because of the reduction in the effective length of the members in compression.

- The wall diaphragm (e)

is assembled using wood-based panels or gypsum-based panels fixed by mechanical fasteners to a timber frames. Shear forces are transferred through nail or screw connections around the panel edges. It is normally fixed to the support with bolts and special anchors to avoid overturning and sliding.

Many buildings are braced by wall diaphragms, because the materials are a natural part of the walls. The only extra cost is that of some connections and that the project must go into great detailing with the drawings. An advantage of the system is that it normally gives acceptable deflections of the building.

- The frames (f)

can give a lot of free area without walls. It is good practice to check that the horizontal deflections are acceptable in order to avoid cracks in the internal walls.

- The truss frames (g)

have the same advantages as the normal frames. It has a reduction in material consumption, but it will often require more work with production of the frames.

- The K-truss (h)

reduces the forces in the internal members and in the effective length of members in compression. In literature like Timber Construction Manual [1] there is information about other truss principles.

2.2 The typical elements in floor and roof

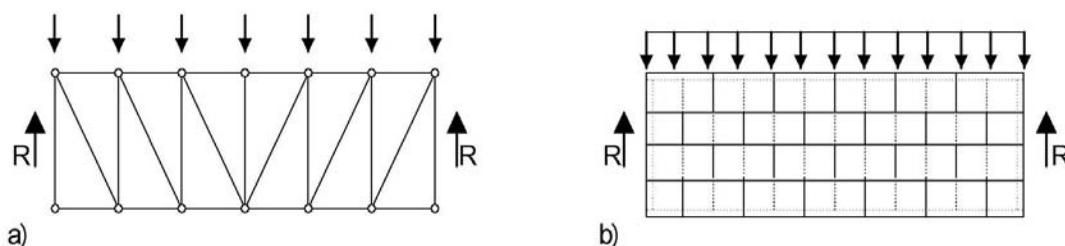

Fig. 14.2 Plans of typical bracing elements in floor and roof

Fig. 14.2 shows typical simply supported elements in floor and roof: a) truss bracing, b) roof and floor diaphragms.

– The truss bracing

in floors or roofs often uses a part of the existing structure. The main beams can be used as the top and bottom chord in the truss. The diagonals will often be executed as a cross.

– The roof and floor diaphragms

often use materials that are an existing part of the structure. The diaphragms are assembled using wood-based panels fixed by mechanical fasteners to a timber frame.

3 Bracing systems for one storey buildings – examples

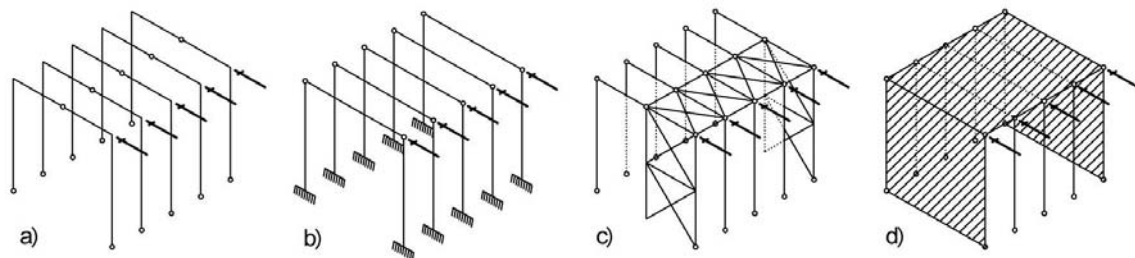

Fig. 14.3 Bracing for transverse loads

Fig. 14.3 shows typical systems for transverse loads: a) frames, b) cantilever columns and beams, c) truss, d) wall and roof diaphragms.

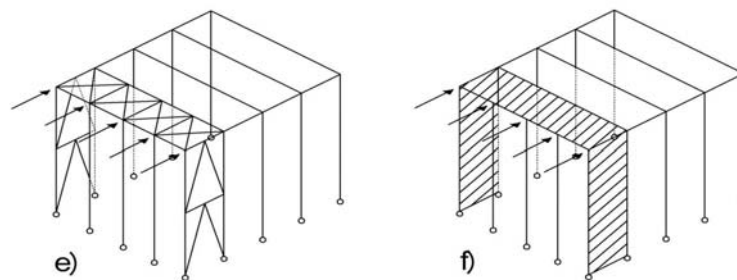

Fig. 14.4 Bracing for longitudinal loads

Fig. 14.4 shows typical systems for longitudinal loads: e) truss, f) wall and roof diaphragms.

Sometimes the systems are combined, for example roof truss with wall diaphragms.

4 Systems to balance internal forces – examples

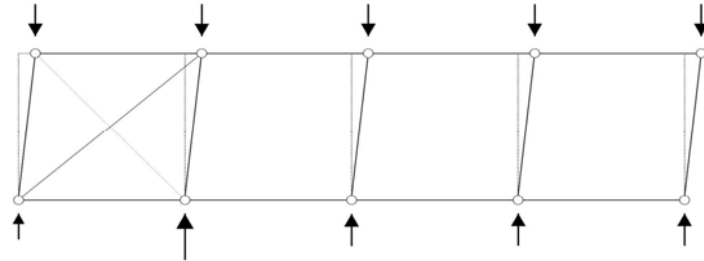

Fig. 14.5 Support reactions from inclined columns.

The wall truss is bracing the columns out of plumb in Fig. 14.5. In combination with the roof bracing all columns in a building can be braced to the wall trusses. In some countries, for example Denmark, the force from elements out of plumb is considered as being a part of the horizontal mass action.

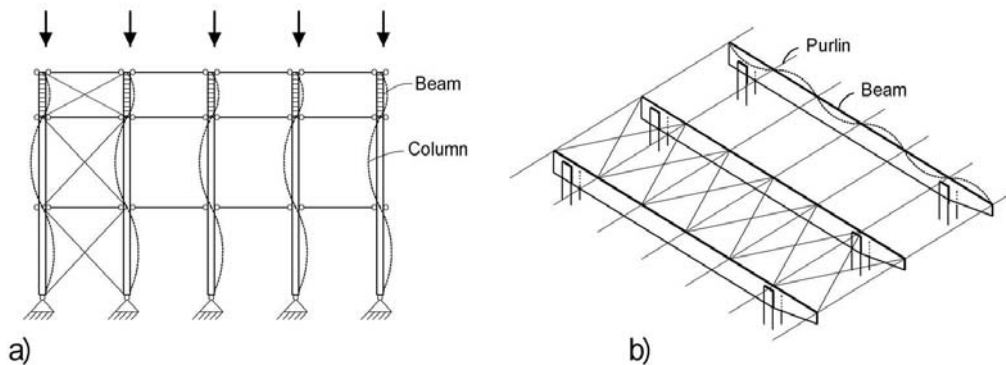

Fig. 14.6 Bracing of columns and beams

Bracing systems are often used to stabilize members in compression and decrease the column-length of the members. The bracing system in Fig. 14.6a can decrease the column length to the half. The bracing at the top provides torsional resistance at the beam ends and support the node between the beam and the column.

The bracing system in Fig. 14.6b can decrease the effective beam length in the design of lateral torsional stability, because the purlins fix the top (in compression) of the beams.

In other structures such as trusses, beams and frames, the tops of the cross sections are often easily fixed at the top to the roof, the storey partition or the facade

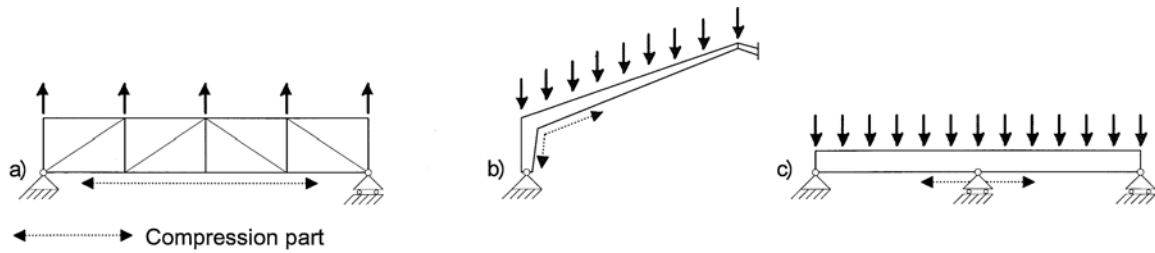

Fig. 14.7 Parts in compression: a) truss, b) frame, c) continuous beam

Sometimes it is also necessary to fix the “bottom”, where there are stability problems with the parts in compression. Fig. 14.7 shows examples with a) truss with suction from wind at the roof, b) frame at the inside of the knee and c) a continuous beam near the centre support.

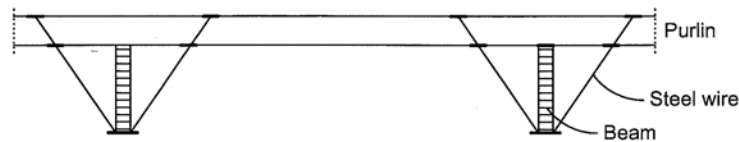

Fig. 14.8 Fixed connection between beam and purlin

Instead of an independent system, which only fixes the bottom, it is often possible to make a fixed connection between the main cross section and the secondary structure. Fig. 14.8 shows an example of fixing the bottom of the beam.

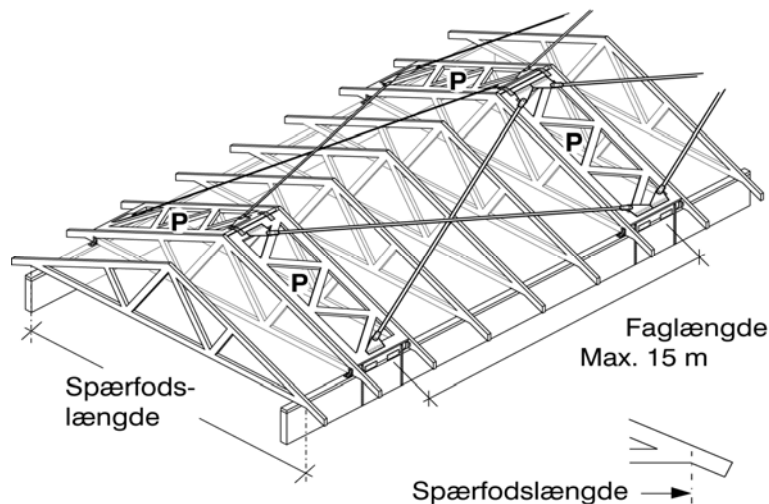

Fig. 14.9 Bracing of trusses (Simpson Strong-Tie).

Fig. 14.9 shows a system to brace the top chords of the truss system with span over 14 m. The parallel trusses (P) in wood, and diagonal bracing in steel in combination with purlins or battens (not shown) constitutes the total system. The benefits are 1) ensures the lateral stability of every truss 2) takes wind loads on the gable and 3) reduces the buckling-lengths of the top chords.

5 Bracing systems for multistorey buildings and combined systems – examples

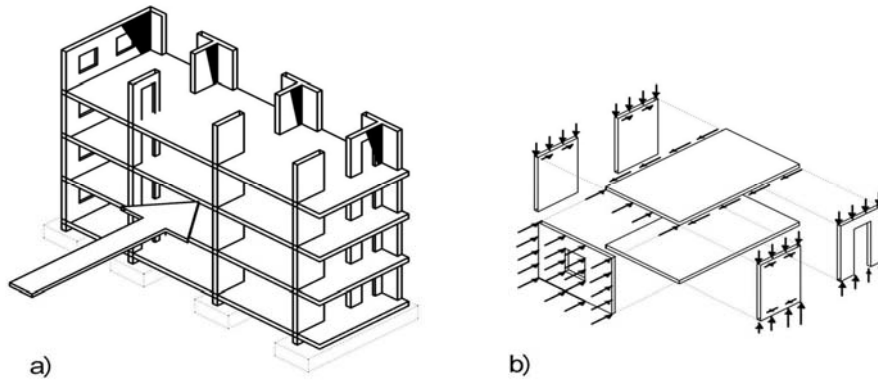

Fig. 14.10 Building with wall and floor diaphragms.

The building on Fig. 14.10a is stabilized with walls and floor diaphragms. Fig. 14.10b shows free body diagrams of some of the walls and floor diaphragms. These are used to calculate the internal forces between the walls and floor.

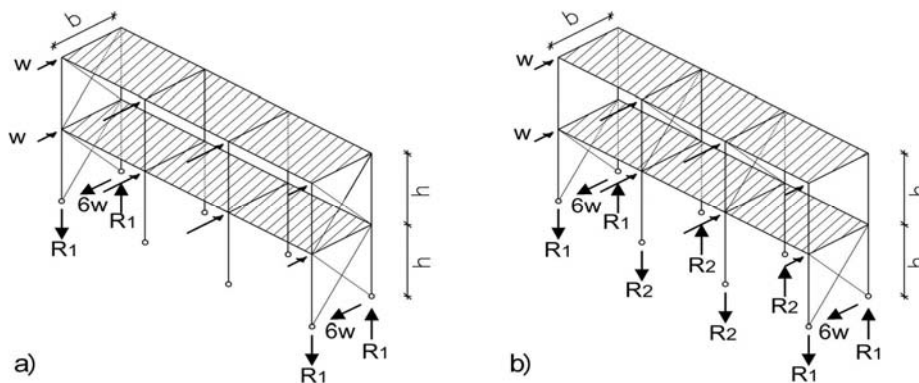

Fig. 14.11 Building with vertical truss and floor diaphragms (transverse load)

Both wall and floor diaphragms can be substituted trusses. In Fig. 14.11a the trusses are placed above each other. Fig 11b shows another possible solution where the trusses are displaced in the different storeys. This reduces the point loads to the foundation from $R_1 = 9 w h/b$ to $R_1 = 6 w h/b$ and $R_2 = 3 w h/b$, but increases the forces in the floor diaphragm.

6 Bracing details – examples

6.1 Bracing in three dimensions

The designer often looks at the main structural elements first and the bracing second. In reality, it is important to acknowledge that it is a combined system in three dimensions with forces acting at the same time. In some structural systems, it gives only small additional forces, whereas in others, the load combinations give bigger forces. In the latter systems, this must be taken into account.

If you look back at the system with frames and truss bracing in Fig. 14.4a, the internal forces in the frames are increased, because the frames are chords in the truss. At the same time, the truss gets loads from stabilizing the frame parts in compression.

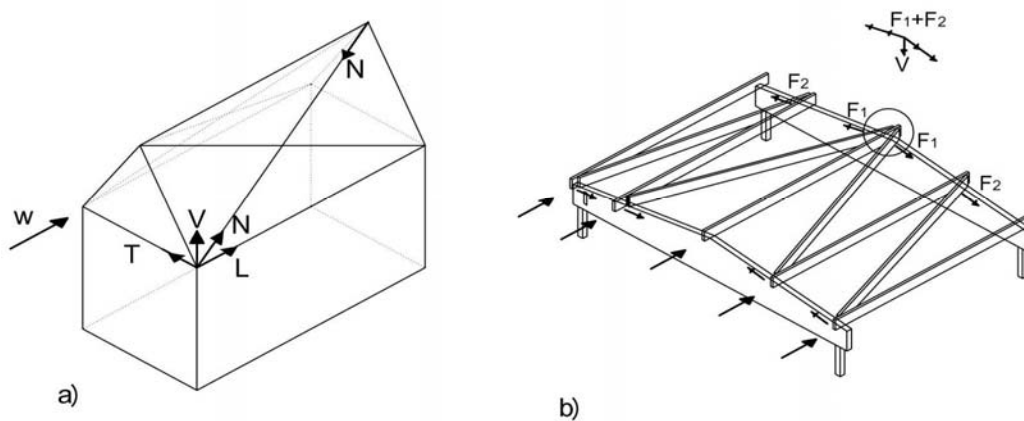

Fig. 14.12 a) End forces in a roof bracing,
b) Vertical forces in a structure caused by horizontal actions

The end force (N) from the diagonal in the roof bracing in Fig. 14.12 a can be divided into a vertical force and two horizontal forces.

The vertical load (V) must be anchored to the building construction or, if necessary, to the foundation. The longitudinal force (L) must go through a vertical brace to the foundation. The transverse force (T) will normally meet an opposite load from the other roof part, but the main structure has to be designed to take this force.

Bracing in roofs with slopes develop inclined forces in the main structure, Fig. 14.12b. The resultant of the forces ($F_1 + F_2$) gives a vertical force. The main structure has to be designed for these forces. If you look back to Fig. 14.12a, the force at the top of the diagonal will also give a vertical force at the apex.

6.2 Connections

It is important to carry out a detailed design of the connections in the bracing system. There are often many joints and the designer must be careful with them all.

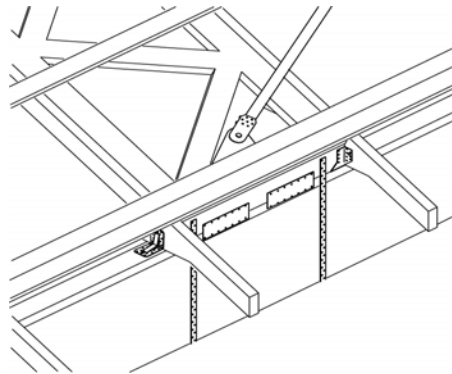

Fig. 14.13 Connection roof bracing to wall (simpson strong-tie)

The connection in Fig. 14.13 is taken from Fig. 14.9. The force from the diagonal (N) (Fig. 14.12a) can be divided. Then the forces must go through many joints on their way to the foundations.

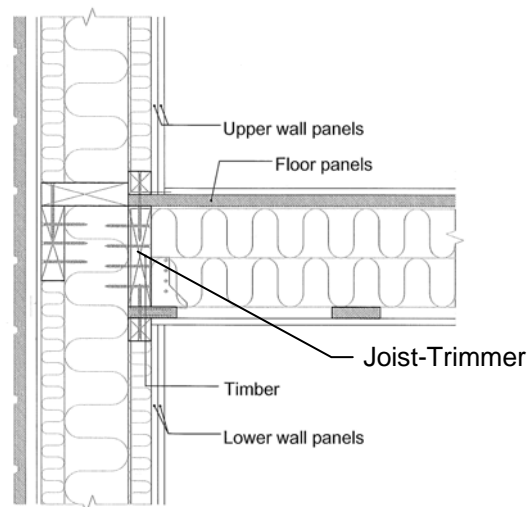

Fig. 14.14 Connection storey partition to facade

There are many joints for the forces to travel through in the detail in Fig. 14.14. The horizontal forces in the upper walls panels (cladding) and the floors panels (floorboards) must be transferred, via several joints, to the lower wall's panels (cladding).

This is achieved through many connections in the following joints 1) the upper wall's panels (cladding)/the upper wall's horizontal wooden soleplate 2) the upper wall's horizontal wooden soleplate/the wooden joist-trimmer in the floor partition 3) floor partitions panel (floorboards)/wooden joist-trimmer in floor partition 4) wooden joist-trimmer in floor



partition/the lower walls horizontal wooden header plate 5) the lower walls horizontal header plate/the lower walls panels (cladding).

7 References

- [1] Thomas Herzog et al.,
“Timber Construction Manual”,
Birkhäuser, Basel, 2004
- [2] H.J. Blass et al.,
“Timber Engineering STEP 2 – Design – Details and structural systems”,
Centrum Hout, The Netherlands, 1995

Chapter No. 14 has been prepared by Anders Søvsø HANSEN, VIA University College, School of Technology and Business, Horsens / Denmark.



TIMBER BRIDGES

1 Introduction

The last two decades have seen a growing interest in timber bridges in many European countries. There are several reasons for this. The growing interest in environmental questions and sustainability has definitely paved the road for more use of structural timber, but also new and innovative use of timber, such as the stress laminated timber deck and better connections, have played an important role. The fact that reinforced concrete did not turn out to be an everlasting material – many countries have experienced serious problems with concrete bridges built in the 1960's and 70's – is another factor. Last, but not least, the enthusiasm of individuals should also be acknowledged.

We start this brief account with a short historical review before we review the most common types and sizes of timber bridges. We then move on to the main structural systems, for both the support structure and the bridge deck. Connections and details are very important for the success of timber bridges, perhaps more so than for other types of timber structures. In general, dynamic excitation is not considered a serious problem for most timber bridges, but some aspects need to be addressed. We also include some notes on erection and economy of timber bridges. The most crucial challenge for a timber bridge is perhaps the question of longevity, which brings in protection and durability as major concerns.

We round off the account with some comments on the Nordic Timber Bridge Project which has proved to be of vital importance for the revival of timber bridges in the north of Europe.

2 Brief historical note

Before the advent of, first cast iron (the Iron Bridge near Coalbrookdale on the river Severn, opened in 1781), then steel (one of the first major steel bridges, the King Albert Bridge over the Elbe, was opened in 1893), and finally reinforced concrete, stone and timber were the only available materials for bridge building. While we have many fine examples of very old stone bridges, this is, for obvious reasons, not the case for timber bridges. Although some covered timber bridges have survived for a remarkably long time, the most famous example being the Kapellbrücke in Lucerne, built in the period between 1300 and 1333, which is still standing (restored after a fire in 1993), most of the timber bridges of the past have disappeared.

Caesar's bridge over the Rhine, built around 50 B.C., is quoted as one of the first major timber bridges in Europe. Andrea Palladio (1508-80), an Italian architect, is often mentioned in connection with timber bridges of the past, both for his introduction of the timber truss bridge design, and for some famous bridges, like the Ponte degli Alpini (1567) at Bassano



which is still there. Another, “Rheinbrücke”, at Schaffhausen in Switzerland, built by Ulrich and Grubenmann in 1755-58, was designed with a single span of 119 m, but the town authorities demanded a pillar put in at mid-span. The “Colossus”, an arch like timber truss spanning 104 m, built in 1812 by Louis Wernwag, is described as both an architectural and engineering masterpiece.

In the United States the building of the railroads in the latter part of the 1800’s produced many, quite large timber bridges. One of them, the Cascade Bridge, built by Thomson Brown as early as 1845, was a truss-arch-truss bridge with a span of 90 meters and quoted by a visiting Swiss engineer to be one of the finest timber structures in the US.

However, with steel and reinforced concrete on the scene, road and railway bridges made of timber more or less disappeared in the 20th century, except for very short spans. In the latter (short span) category, a very large number of timber bridges exist in both North America and Australia, but most of them are fairly insignificant structures and hardly considered to be bridges by the travelling public. Most structures considered to be timber bridges, built in the 20th century, are footbridges. Around 1990 there is a change, and we see a gradual increase in the number of road bridges made of timber.

3 Types and sizes

Bridges are naturally divided into two major groups: footbridges and road bridges (for vehicular traffic). We will focus on the latter, but we start with a short review of timber footbridges.

3.1 Footbridges

The term footbridge also includes the bridges for combined pedestrian and cycle traffic. Such bridges come in all shapes and sizes. Most of them are simple beam-type bridges, either with massive glued laminated timber (*glulam*) sections or as truss beams, and typical span lengths are in the 15 to 30 meter range. However, we also find a large number of innovative and spectacular designs, such as the 192 m long bridge at Essing in Germany (with a free span of 73m), over the Rhein-Main-Donau-Kanal, built in 1992 and shown in Fig. 15.1.



Fig. 15.1 Footbridge over the Rhein-Main-Donau-Kanal at Essing, Germany (photo: J. Sivertsen)



Another interesting footbridge is the so-called Leonardo bridge. Inspired by Leonardo da Vinci's sketch of a stone bridge over the "golden horn" (from Istanbul to Pera), Norwegian artist Vebjørn Sand managed to create sufficient interest (and money) to build a rather spectacular glulam bridge across a major road (E-18) at Ås, south of Oslo. The bridge, built in 2001 and shown in Fig. 15.2, is about 120 m long with a main span of about 40 m. It should be noted that the bridge replaced one of the ugliest footbridges in the country.

Figure 15.3 shows another recent Norwegian footbridge, built at Lardal in 2001. A creosote impregnated glulam bridge with a steel cable reinforcement in the mid-section, it has a free span of 92 m and a total length of about 130 m. This bridge has some dynamic problems which we shall return to in a later section.



Fig. 15.2 The Leonardo footbridge at Ås, south of Oslo, Norway (photo: Moelven Limtre AS)



Fig. 15.3 Footbridge at Lardal, Norway (photo: A. Rönquist)

3.2 Road bridges

The vast majority of timber bridges for ordinary road traffic are short span (5 to 20 m) slab and beam type bridges, often made as wood-concrete composite structures. Some 20-25 years ago timber became an interesting material also for longer bridge spans, both in Europe and North America, and we now find a fair number of medium size timber bridges, even on major roads. Figures 15.4, 15.5 and 15.6 show some typical examples of modern timber road bridges.

Figure 15.4 shows the “Wennerbrücke” over the river Mur at Murau in Austria. Built in 1993, this is probably the first large timber bridge built in Europe to serve a major road. The main components of the support structure are four parallel, parabolic 3-hinge arches spanning 45 m. The glulam arches, together with straight glulam columns, support four massive glulam girders which in turn supports a pre-cast and post-stressed concrete deck. The total bridge length is 85 m. All glulam (300 m³) is made of untreated larch wood, which was later surface treated with stain. An important feature of this bridge is the “roof effect” of the bridge deck.

In Fig. 15.5 is shown the Vihantasalmi bridge at Mäntyharju in Finland. The main support system consists of three glulam king-post trusses, each with a free span of 42m. The total length of the bridge is 182 m; it was completed in 1999. The deck is a concrete-steel-glulam composite structure, in which glulam girders provide the longitudinal bearing, steel trusses the sideway stiffening and concrete the deck itself. The timber is creosote impregnated.



Fig. 15.4 “Wennerbrücke” over the river Mur at Murau, Austria
(photo: Institut für Holzbau und Holztechnologie, TU Graz)



Fig. 15.5 Vihantasalmi bridge at Mäntyharju in Finland (photo: K.Bell)



Fig. 15.6 Tynset bridge, Norway (photo: K.Bell)

Tynset bridge, shown in Fig. 15.6, is supported by three times two arches. The main arch, a 2-hinge glulam truss arch, has a free span of 70 m, whereas the two smaller arches are 3-hinge arches of massive glulam, each with a span of about 26.5 m. All structural glulam is creosote impregnated and copper clad. The arches support cross beams of steel which in turn supports a 223 mm thick stress laminated timber deck made of creosote impregnated structural timber. The total length of the bridge, built in 2001, is 124 m.

4 Structural systems

The examples shown in the previous section are typical of modern timber bridge design, and they indicate the span range current technology can handle. Given the right conditions it is probably feasible to bridge a span of well over a 100 m with a timber structure, but the normal span for a timber bridge is in the range of 5 to 75 m.

4.1 Arches

The fact that half the bridges shown above are arch bridges is no coincidence. In the majority of modern timber road bridges one finds arches in one shape or another. For uniformly distributed load the arch will carry the load almost exclusively by axial compression and is thus a very economical shape.

4.1.1 Geometry, material and configurations

In principle we have three different arch designs, as shown in Fig. 15.7. The arch is normally in the shape of a parabola (Wennerbrücke) or a circle (Tynset). The ratio between span (L) and height or rise (h), that is L/h , is in the range from 4 to 8. The material is, for all practical purposes, glulam, and the cross section is normally a massive rectangle for the lower spans, up to about 50 m, whereas truss arches are the norm for the larger spans. Both production and transportation limit the size of curved glulam.

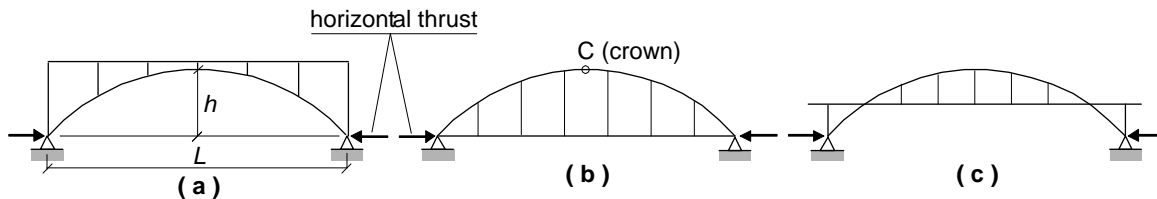

Fig. 15.7 Arch bridge designs

members with massive cross sections, and a consequence of this is that most such timber arches are made in the form of 3-hinge arches, as indicated by the hinge at the crown (C) in Figure 15.7b. This, of course, renders the arch statically determinate, which in itself can be an advantage in case of changes in moisture and temperature and settlements of the supports.

In Fig. 15.7a the arch is located under the deck, as for Wennerbrücke, and the deck is supported by the arch through compression (timber) members. In Fig. 15.7b the arch is placed above the deck which is suspended from the arch by (steel) tension members. In the last case, Fig. 15.7c, we have an intermediate solution. In all cases the vertical loading, dead load and traffic load, is transmitted to the arch, by (usually) vertical members, and the arch take the load to the supports, mainly as axial compression. This compressive force has a very significant horizontal component at the support, the horizontal *thrust*. In cases a) and c), this thrust must be absorbed by the support itself, which may or may not be a problem. In case b) we have two possibilities of neutralizing the thrust: by the supports (abutments) themselves, as in cases a) and c), or by a *tie rod* between the arch supports.

Having the support structure beneath the deck, as in Fig. 15.7a, has three distinct advantages: 1) the deck serves as a protective “roof” for the support structure, 2) no limitation as to the number of (parallel) arches, and 3) transverse stiffness of the support system is (normally) easily obtained.

However, in many cases the bridge site does not lend itself to this solution, and the arches will have to be placed above the deck, as in Fig. 15.7b. With this design, and also the intermediate design in Fig. 15.7c, the number of arches, for a two-lane bridge, is normally two, one on each side of the bridge.

4.1.2 Some problems and challenges

If the arches are placed above the deck, sideway stiffening of the arches can be a problem. Given enough height, a “wind truss” between the arches, in which the arches form the chords, is the obvious choice (as indicated for the main arch of the Tynset bridge in Fig. 15.6). There will, however, always be a fairly long unsupported portion at the lower part of the arch, and this may call for additional measures.

For shorter spans, the height does not permit such a truss, and alternative methods must be found. For each of the two smaller arches of the Tynset bridge (Fig. 15.6), where $L = 26.5$ m and $h = 5.8$ m, there is not room for a truss. Instead, the two middle *hangers* are made of steel sections with significant bending stiffness, and these hangers are *rigidly* connected to the steel cross beams, thus forming two U-shaped frames which provide transverse stiffness to the arches.

With vertical hangers (and columns in case of arches below the deck) the large concentrated axel loads, from real or imaginary heavy trucks that all bridge load codes specifies, will cause significant bending moments and shear forces in the arches, in addition to the axial compression. The two bending moment diagrams in Fig. 15.8, taken from a feasibility study of a 2-hinge arch bridge with a span of 80 m, demonstrate this very clearly. Fig. 15.8a shows the standard design, with vertical hangers, whereas Fig. 15.8b shows an alternative design with inclined hangers, the so-called *network arch*.

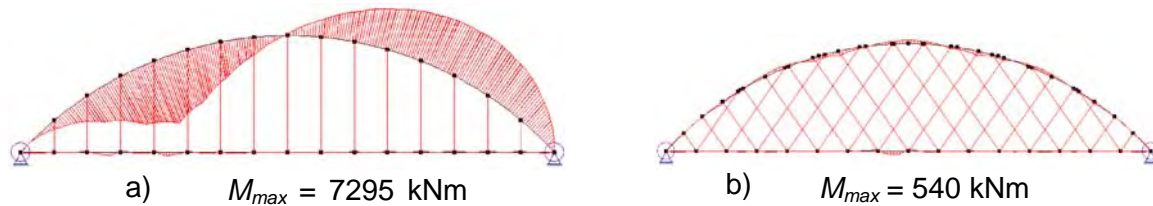

Fig. 15.8 Bending moments for two different cable arrangements, but roughly the same traffic loading

Both diagrams are drawn to the same scale, and the traffic loading is roughly the same, but placed such as to give the highest moments in the arch in both cases. The axial compression, which does not vary much along the arch, is quite similar for the two cases, although slightly lower for the network arch. We see that the network arch introduces the loading from the deck to the arch in a much more favorable way, particularly when the traffic loading is placed towards one of the supports. This is, however, not the complete story. Network arches have their problems too.

High bending moments and shear forces caused by the large concentrated forces introduced in the arch by concentrated traffic loading through the vertical hangers represent several problems. One in particular, associated with tension perpendicular to grain, should be mentioned. In Fig. 15.9 is shown the bending and shear force diagrams for one of the smaller arches of the Tynset bridge (Fig. 15.6), obtained by a 2D frame analysis with the concentrated traffic loads placed near the leftmost hanger. The bending moment on the left hand side of the arch, causing tension on the concave side, produces (moment induced) tension perpendicular to grain ($\sigma_{t,90,d}$), we also have a large shear stress (τ_d), and satisfying the combined check of Eurocode 5 - EN 1995-1-1 (EC5-1), formula (6.53), may not be an easy task.

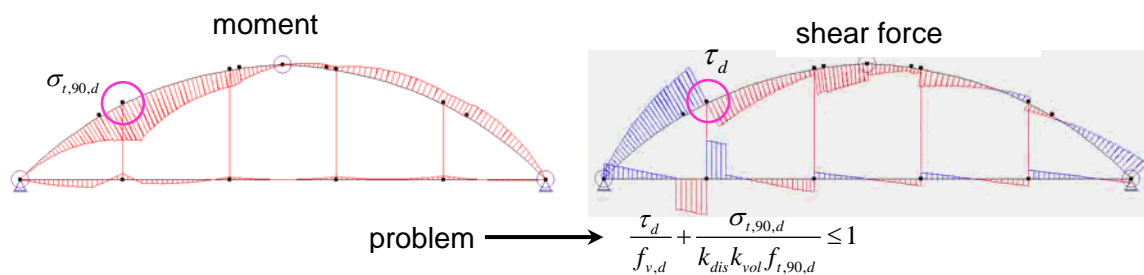

Fig. 15.9 Combined tension perpendicular to grain and shear stress – a problem for arches with vertical hangers

4.2 Trusses

The alternative to arches for road bridges with span over, say 20 m, is trusses in one form or another. Again we have the three configurations of Figure 15.7: the parallel trusses may be placed below the deck, as shown in Fig. 15.10a, which enables more than two trusses, they may be placed above the deck, as shown in Fig. 15.10b, or, more unusual, the deck may be placed between the top and bottom chord of the truss.

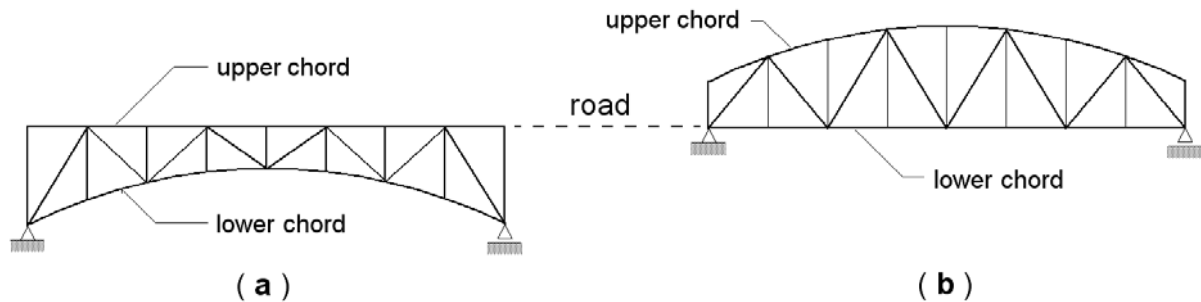

Fig. 15.10 Examples of trusses for road bridges, a) below the deck and b) above the deck

For long spans, the lower chord will usually be curved for a truss below the deck (Fig. 15.10a), whereas it is the upper chord that may be curved if the truss is placed above the deck, as shown in Fig. 15.10b. The truss has an advantage over the arch in that it has no horizontal thrust at the supports. It also has fewer limitations with respect to production and transportation, since the chords may be assembled of several parts joined at nodal points. Connections represent a challenge, and transverse stiffening of the top chord, in the case of a design with the truss above the deck, is not necessarily a trivial problem.

4.3 Other systems

For road bridges with a span over 20-25 m, arches and trusses dominate. For very short spans, up to about 15-20 m, timber *plates* of various makes are used as both load bearing system and bridge deck. Also timber *beams* are used as the main structural element for the shorter spans, often in connection (and interaction) with reinforced concrete slabs.

For footbridges we find the same support systems as for road bridges, but in addition we also find a variety of mixed systems, often using steel cables/wires as additional structural elements (suspension type bridges and cable stayed variants).

5 Bridge decks

The vast majority of timber footbridges have decks made of timber, in one form or another, from simple timber boards or planks to crossed layers of boards and various types of laminated decks. For road bridges the situation is more complex. We find that the standard building materials, that is, reinforced concrete, steel and timber, are used in many different combinations, from “pure” concrete decks to almost “pure” timber decks. One might rightly ask, how much timber needs to be used in a bridge for it to be called a timber bridge? Usually the dominating material employed in the main support system will decide, and since the deck is, in most cases, a secondary bearing system it will not take precedence. Hence,

the Wennerbrücke (Fig. 15.4) is definitely a timber bridge, although the deck is made of concrete.

For lack of space, we will concentrate on one particular type of deck made predominately of timber, the so-called *stress laminated* timber deck. The idea comes from Canada where it was first used in 1976 by the Ontario Ministry of Transportation and Communication for rehabilitating deteriorated nail-laminated lumber bridge decks. The method was successful and it was soon recognized that it offered a variety of possibilities also for the construction of new bridges. It was developed in Canada and the US, but soon found its way to Europe and Australia.

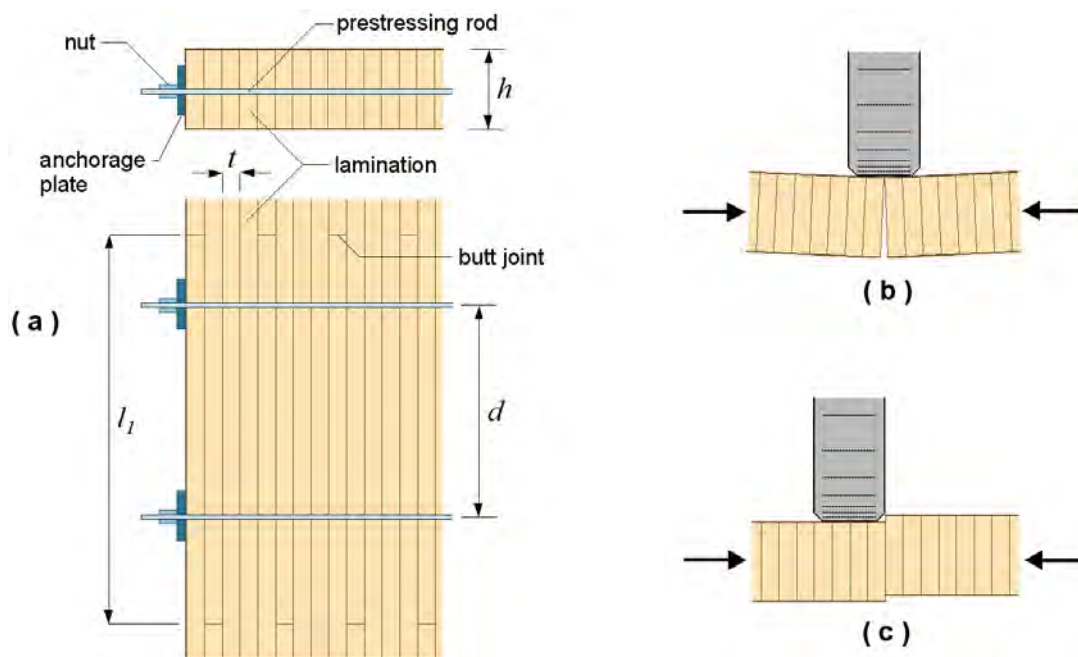

Fig. 15.11 Stress laminated timber deck - terms and principles

The basic idea is shown schematically in Fig. 15.11. Timber lamellas (planks of structural timber or glulam beams) are stacked, side by side, in the full width of the deck, and prestressing rods, through pre-drilled holes at regular intervals (d), will, when stressed, make the assembly of lamellas behave like an orthotropic plate. In Fig. 15.11b we see that transverse bending tends to cause an opening between the laminations on the underside of the deck, and in Fig. 15.11c transverse shear produces a tendency for laminations to slip vertically. Both these effects must be counteracted by the pre-stressing forces, and most codes, including Eurocode 5 - EN 1995-2 (EC5-2), require that the long term pre-stressing forces prevent all inter-laminar slip to occur.

Lamellas are of limited length, and they therefore need to be joined, butt to butt, as indicated in Fig. 15.11a. EC5-2 requires that not more than one butt joint shall occur in any *four* adjacent laminations within a length l_1 defined as the minimum value of

$$2d, 30t \text{ and } 1.2 \text{ m}$$

where t is the thickness (width) of the lamination and d is the distance between the prestressing rods, see Fig. 15.11.

In Norway just about all timber road bridges built during the last decade have stress laminated timber decks, in which the laminations in most cases are 48 by 223 mm, creosote impregnated pine planks. The length of the laminations is normally around 6 m. The pre-stressing rods are of the same type as used for concrete (typically Dywidag 15 FW) usually placed at a distance (d) of around 600 mm. The initial pre-stress results in a normal stress between the lamellas of approximately 1 MPa. If stressed only once, most of the pre-stress (80 % or even more) will be lost due to creep effects and variation in wood moisture content. The normal procedure is to come back and re-stress the rods at least once, after 6 to 12 months, and after that the loss is quite moderate. Figure 15.12 shows the laying of the stress laminated deck on the Evenstad bridge (1996), and a detail of the pre-stressing rods of yet another Norwegian timber bridge (Måsør bridge, 2005). It should be mentioned that the laying of such a deck is a logistic challenge; more than 40 different kinds of pre-drilled lamellas were used in the deck at Evenstad (which is about 180 m long), and each lamella was painstakingly marked with its type number.



Fig. 15.12 Laying the deck of Evenstad bridge (photo: Moelven Limtre) and detail of Måsør bridge (photo: K. Bell)

The maximum height (h) of commercial sawn timber in Norway is 223 mm. With this height the span of a stress laminated timber deck for a road bridge is around 5m, a bit more for an inner span of a continuous deck and a little less for the end span. With glulam lamellas it is of course possible to increase the span length.

It is very important to prevent surface water from penetrating the asphalt wearing course, and some kind of impregnable membrane is therefore placed between the timber deck and the asphalt. Since this is a relatively new concept put to work in a structure designed for a long service life it is important to obtain reliable information about its long term performance. The Norwegian Public Roads Administration has, therefore, put in place quite extensive instrumentations on several of the recently built timber bridges, concentrating in particular on the stress laminated decks. The properties monitored are mainly moisture content in the bridge deck and loss of pre-stressing force in the steel rods. It is too early for strong statements, but some preliminary findings seem to indicate that the moisture content in bridge decks with watertight membranes stabilizes at a level of about 10%, independent of the ambient equilibrium moisture content. The loss of pre-stressing force is considerable in the period following the initial stressing, but after re-stressing and some more loss, the force seems to stabilize as the moisture content stabilizes. However, the pre-stressing force varies significantly with temperature changes.



As already mentioned, the stress laminated timber deck behaves as an orthotropic plate, and the code (EC5-2) suggests that it should be analyzed as such. However, simplified methods, considering the “plate” as a grid, or even as one or several fictitious beams in the direction of the laminations, may also be used. The code specifies the material properties to be used, and it suggests an effective width of the fictitious beam. For the ultimate limit state, the code specifies how to check the bending and shear strength, but it has an additional requirement on the shear force which involves the minimum long-term residual compressive stress due to pre-stressing ($\sigma_{p,\min}$) and the design value of the coefficient of friction, μ_d , between the lamellas.

6 Connections and details

Connections play an important role in all types of timber structures of some size, and timber bridges are no exception. If anything, their role is even more critical for these structures since we normally need to consider service class 3. The large road bridges in particular put heavy demands on the connections.

For lack of space and the experience of the author, we narrow the problem down to the “Norwegian solution”, which makes extensive use of slotted-in steel gusset plates in combination with steel dowels. This type of connection was, for very large timber structures, pioneered by Moelven Limtre AS in connection with the roof structures for three large halls built for the 1994 Olympic Games at Lillehammer. Taking this connection from a protected indoor environment to the rather harsh Norwegian outdoor climate required some serious considerations, but in the end it was thought to be feasible. Steel quality and dimensions as well as corrosion protection were major concerns in view of the long service life required (100 years). Depending on how well the connection can be protected against direct contact with water (from rain and/or splashing), even stainless steel have been used.

Figure 15.13 shows some typical examples, reproduced with the permission of Moelven Limtre AS who designed the connections in collaboration with Norconsult AS, the acting consulting engineers. Both examples are from the Tynset bridge, see Figs. 15.6 and 15.9. On the left-hand side, Fig. 15.13 shows how the leftmost hanger in Fig. 15.9 is connected to the arch (the connection marked with a circle). It should be noted that the massive cross section of the arch is in fact made up of four glulam arches, glued together along the side surface(s) to form a section that is 710 mm wide. The slots for the steel plates are sawn from both sides (indicated by the dotted circles), but it should be kept in mind that the arch has a copper “roof” that will protect the connection from rain. On the right-hand side, Fig. 15.13 shows the connection at a nodal point on the top chord of the major (truss) arch. Note that the chord itself is also joined at the nodal point, and in addition to the two diagonals a transversal of the bracing (wind) truss also joins on to this point. Note also the gap (of 20 mm) between the two parts of the chord member. This gap is injected with an expandable mortar once the arch has been assembled. This substance, when set, is capable of transmitting higher compressive stresses than the timber.

The durability of outdoor timber structures is very much a question of moisture. Rule number one is to keep the water out, and rule number two is to make sure that it can escape through adequate “ventilation” when it cannot be kept out (which it normally cannot). Proper detailing is extremely important in this respect. Inspection of a large number of wooden footbridges in Norway showed that most of the deterioration was caused by poor detailing, such as unprotected end wood, lack of space for the moisture to escape, once it was in, and vertical

compression members resting directly, without any or proper protection, on surfaces that would regularly become wet. Details can also influence the

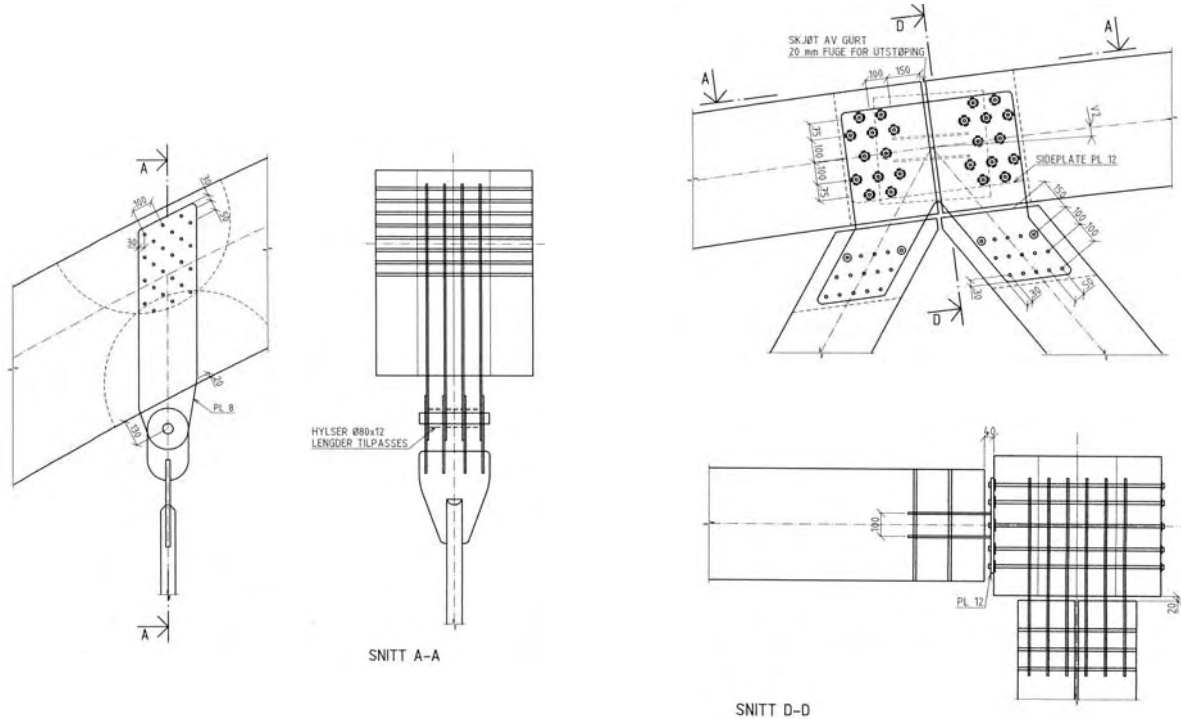

Fig. 15.13 Examples of connections in Tynset bridge (reproduce by permission of Moelven Limtre AS)

aesthetic expression of the bridge. Figure 15.14 shows two details of the Tynset bridge (Fig. 15.6), one of the hinge at the crown of one of the smaller massive arches, and the other of the base support of the two arches. Here the architect has obtained quite nice effects, through modest means.



Fig. 15.14 Details of the Tynset bridge (photo: K. Bell)

7 Dynamic effects

Wooden road bridges are normally not slender structures and hence not very susceptible to severe dynamic effects. Save for earthquake excitation, which is a problem for most structures in earthquake prone areas, *fatigue* is probably the one dynamic effect that most road bridges need to address. For a timber bridge the traffic loading is normally larger, in relation to the permanent loading, than for other types of bridges, and consequently the range of varying stresses can be significant. Fatigue is not considered to be much of a problem for the timber itself, but connections are a different matter. Tests carried out for the dowel type connection used extensively in Norwegian road bridges show that such connections can in fact fail in fatigue [1]. These results, and others, have been used to calibrate the current (informative) requirements of EC5-2 on this problem (Annex A).

While vibrations of timber road bridges are normally negligible, this may not be the case for footbridges, which can often be quite slender. Pedestrian induced vibrations, in particular, can be a problem, and the code (EC5-2) has a separate annex (B) devoted to this problem. As an example, let us go back to the Lardal footbridge in Fig. 15.3, a computer model of which is shown in Figure 15.15.

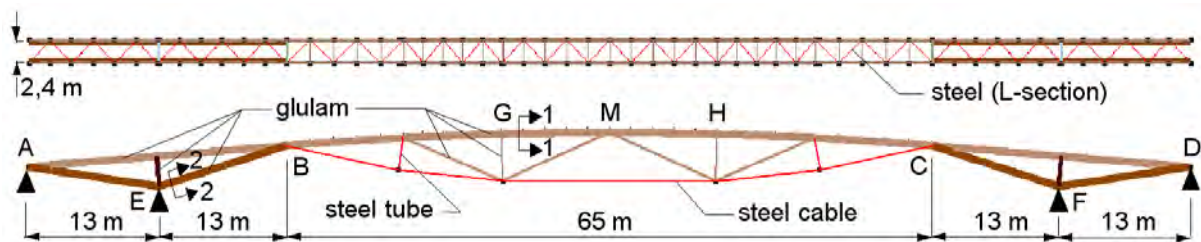

Fig. 15.15 Structural system of Lardal footbridge (see also Fig. 15.3)

On opening day a fair number of people attended which led to a dense flow of people across the bridge. And the London Millennium bridge syndrome repeated itself: very noticeable *lateral* vibrations were observed and experienced. Some people grabbed the handrails and verbally expressed concern about the behavior of the bridge. This came as somewhat of a surprise to the consulting engineers since this mode shape had not been detected by the dynamic analyses carried out during the design phase. The bridge became the subject of a PhD study [2], and the problem – which is still not resolved – is also summarized in a presentation at WCTE 2006 in Portland [3]. The mode shape causing the problems is shown in Fig. 15.16.



Fig. 15.16 First horizontal mode shape of Lardal bridge – eigenfrequency 0,83 Hz (the lowest eigenmode)

The computed eigenfrequency is the same as the value actually measured on the bridge. It should be mentioned, however, that it took quite a bit of model tuning before the measured frequency was attained. The first torsional and vertical modes, with measured eigenfrequencies of 1.12 Hz and 1.45 Hz, respectively, were not excited by ordinary pedestrian traffic.

In [3] various ways to stiffen the bridge sideways were looked into, but the tentative conclusion is that with the current ratio of width to span length, this bridge design is pushed to its limit, and perhaps beyond. After all, it is a very slender structure.

8 Protection and durability – maintenance

Bridge structures are normally designed for a long service life, from 60 to 100 years. In Norway the normal service life for a bridge is 100 years, also for timber bridges. Is this realistic without extensive and costly maintenance work? The answer to this question may differ, depending on your preferred material, and depending on where you live. Some countries are far more restrictive than others when it comes to the use of chemical treatment of the timber.

Modern timber bridges have not been around long enough for conclusive statements to be made. However, if we look at some of the timber bridges of the past, some of which have been, or were in service for more than 100 years, it seems quite feasible to build long lasting timber bridges. The main enemy is moisture. As already mentioned, rule number one is to keep the water out. That is not always possible, and even if we can make adequate cover for rain and snow, the timber will be subject to the moisture of the ambient air. It is therefore almost as important to make sure that the timber can dry out, through proper “ventilation”, as it is to keep the water out.

The resistance to moisture depends on the type and quality of the timber. Structural timber in the Nordic countries is, almost exclusively, limited to spruce and pine. Siberian larch, which is believed to be a more durable species, is used, but not nearly as much as on the continent. Tests carried out in Norway seem to indicate that larch is not significantly more durable than heartwood of pine.

Chemical preservatives can significantly improve the durability of structural timber, in particular pressure impregnation. In the Nordic countries, only pine is a candidate for pressure impregnation, and the type of preservative is either salt, e.g. copper (CU), or creosote. Different countries have different rules for the use of preservatives. In Europe, Norway and, to some extent, Finland, have up till now been quit liberal and allow both salt and creosote impregnated timber to be used in some infrastructure construction, such as bridges and power line masts and poles. Hence, the Norwegian practice up till now has been to use a “double dose” of chemical treatment of all critical components in timber bridges. This treatment consists of salt pressure impregnation of the lamellas before gluing, followed by pressure impregnation with creosote of the finished component, e.g. one half of a 3-hinge arch. In spite of this rather massive chemical treatment, most surfaces with a horizontal component are also “mechanically” protected, for instance by copper cladding. As an example, the top side of all arches of the Tynset bridge (Fig. 15.6) are covered by copper cladding, also the top side of the lower chord of the main truss arches.

Another example is shown in Fig. 15.17 of a more recent arch bridge, Fretheim bridge. The 3-hinge arch has a free span of about 40 m, and the picture gives a good impression of the copper “roof”. We also see how the arch support, which accommodates a (double) steel tie rod, is made to cover the entire base of the arch. Both sides of the arch are covered by a creosote Venetian blind type protection that will keep both rain and sun away from the arch, and at the same time provide adequate “ventilation” of the massive glulam arch. In this particular case the arch itself is *not* creosote impregnated, but the glulam is pressure salt impregnated (with CU). One might rightly ask if impregnation of the arch is at all necessary in this case.

Most countries have a much tougher attitude towards chemical preservatives than the current practice in Norway, and it is almost certain that Norway will soon have to impose restrictions similar to those adopted by most European countries. The arches of Fretheim bridge in Fig. 15.17 is an example of the kind of design that could do with very little, if any chemical protection. The glulam arch ought to survive nicely without any chemical treatment at all. The “Venetian blinds” on the sides of the arches can certainly be made without creosote impregnation; they would probably need some stain from time to time, but, if properly designed, this operation could be carried out on dismantled “panels of blinds”.



Fig. 15.17 Fretheim bridge at Flåm in western Norway
(photo: R. Abrahamsen, SWECO Grøner AS)



If need be they could also be replaced once or twice during the life span of the bridge, without significant costs.

It is interesting to note that plans are now being worked out for some additional protection of the arches and columns of the Wennerbrücke (Fig. 15.4), which has now been in operation for almost 15 years. It is only the outward facing surfaces of the arches and columns on both sides of the bridge that will be covered, to protect against both rain (during windy conditions) and sunshine. The cladding will be made of wood, but the design is not yet finalized.

If properly designed and protected, the cost of the maintenance work on a timber bridge is believed to be of the same order as for concrete and steel bridges. If the timber bridge has a stress laminated timber deck, the tension bars will probably need re-tensioning from time to time. Current belief in Norway is that the frequency of this work is about 15 years. However, this type of deck does not seem to require an elaborate expansion joint at the end of the deck. Measurements show that the moisture content vary very little over the year, and with its very low coefficient of thermal expansion (in the grain direction), there is very little longitudinal movements in the deck. Evenstad bridge (Fig. 15.12), which has a 180 m long stress laminated timber deck, has in fact no expansion joints, and you cannot see any major cracking in the asphalt surface. Some minor cracks in the transverse direction, at intervals corresponding to the distance between the cross beams, can be seen, but they are of no great concern.

9 Erection and economy

Perhaps one of the most convincing arguments in favor of a timber bridge is its quick and relatively easy erection. Sections may be assembled on site and, due to relatively low weight, hoisted in place by mobile cranes. Figure 15.18 shows how a section of the Evenstad bridge across the river Glomma in southern Norway is hoisted on to its concrete pillars in the river. This bridge, erected in 1996, consists of five equal truss sections, made of creosote impregnated glulam. The span of the section is about 36 m. Each section was assembled on site and transported on a temporary “road” built into the river (see the left-hand picture in Fig. 15.18), and then hoisted on to the pillars (right-hand picture). With all sections in place, the temporary road was removed (in parallel) with the laying of the stress laminated deck, see Fig. 15.12.



Fig. 15.18 Erection of Evenstad bridge in 1996 (photo: Moelven Limtre AS)



All timber road bridges built in Norway during the last decade, and we now have a fair number of such bridges, has been built after careful consideration of various criteria, economy being one of the most important. In most cases timber has competed favorably on price with steel and concrete, especially if a similar design (e.g. arch or truss) is considered. For the Tynset bridge (Fig. 15.6), the most economical design was a straightforward steel girder bridge. However, the people of the village of Tynset demanded a landmark structure to replace the old, one lane, suspension bridge. An arch bridge made of steel turned out to be more expensive to build than the chosen timber design.

For certain span lengths (5 - 50 m) timber bridges, or composite timber-concrete bridges, are economically attractive alternatives also in Sweden and Finland. The bridge site can be an important factor in the choice of bridge type and material, and if quick erection is of importance, with its economic implications, timber may well win the day.

10 The Nordic Timber Bridge Project

The revival of the timber bridge in the Nordic countries is a result of the Nordic Timber Bridge Project which was carried out in three phases from 1994 to 2001. The main objective of the program was simply to increase the competitiveness of timber as a bridge material compared with concrete and steel. The program was a joint effort by Finland, Norway and Sweden. Denmark did also participate in the two first phases of the project, and Estonia was an observer throughout the project period.

The total budget of about NOK 20 million was financed by timber industry and road/bridge authorities (50%), Nordic Industrial Fund and Nordic Wood (30%) and National research funds (20%). The total project was divided into about 20 sub-projects covering the whole area, from market research and economy to structural design and durability. Each sub-project produced its own report.

Three Nordic Timber Bridge Conferences were organized as well as a number of national workshops and seminars. A number of papers and articles were published at conferences, magazines, periodicals and newspapers. An important outcome of the project was the emergence of a limited number of dedicated enthusiasts who managed to overcome some deeply rooted scepticism and were able to complete a couple of successful pilot projects.

More details on the project can be obtained from the national contact persons listed in Ref. [4].

11 Concluding remarks

The strong Norwegian angle of this chapter does not in any way imply that Norway has a leading role in timber bridge design. Rather, it is the result of the author's experience. Some solutions presented are particular to Norway, mainly due to our fairly liberal rules concerning chemical preservatives, but hopefully the chapter will give an overall picture of modern timber bridge design. This is, however, a fairly new area and there are still many challenges, particularly concerning durability in a future that will not tolerate much use of hazardous chemicals. Connections represent another challenge, and we will probably also see new or modified support structures with novel protection schemes that will secure a long service life with moderate maintenance costs.



In Norway our modern timber bridges have been well received by both those living near them and others who use them, and it seems fair to state that timber bridges are here to stay.

12 References

- [1] K.A. Malo, A. Holmestad and P.K. Larsen,
“Fatigue strength of dowel joints in timber structures“,
9th World Conference on Timber Engineering, WCTE 2006, Portland, Oregon, August 2006
- [2] A. Rönquist,
“Pedestrian induced lateral vibrations of slender footbridges“,
Doctoral Theses 2005:102, Norwegian University of Science and Technology,
Trondheim
- [3] A. Rönquist, L. Wollebæk and K. Bell,
“Dynamic behavior and analysis of a slender timber footbridge“,
Conference on Timber Engineering, WCTE 2006, Portland, Oregon, August 2006
- [4] Nordic Timber Bridge Project – contact persons:
Finland: Aarne Jutila / aarne.jutila@hut.fi
Norway: Erik Aasheim / erik.aasheim@troteknisk.no
Sweden: Martin Gustafsson / martin.gustafsson@tratek.se

Chapter No. 15 has been prepared by Kolbein BELL, Norwegian University of Science and Technology, Trondheim / Norway.

Chapter No. 16

DURABILITY OF TIMBER STRUCTURES

1 Introduction

We can define the durability of timber as its resistance to physical, chemical and biological destructive conditions. The measure of durability is the time period during which it keeps its usability properties in normal exploitation conditions. Durability is different for various kinds of timber, but in general does not depend on its density but on the presence of some components that are damaging, such as fungi and insects [2]. This is the main reason why sapwood timber is always vulnerable to biological decomposition, while heartwood timber is much more durable (Fig. 16.1, Tab. 16.3).

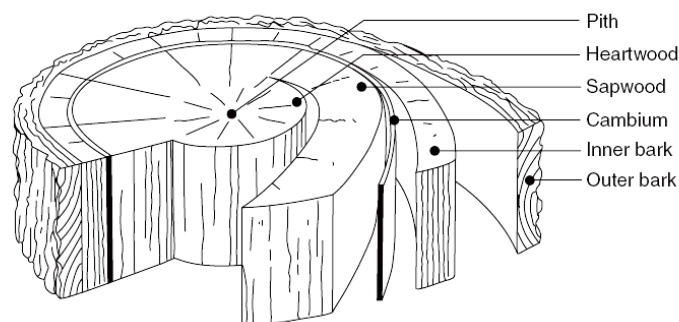

Fig. 16.1 Cross-section of wood trunk

2 Natural durability of timber

A general division of wood species for the sake of its durability depends on storing conditions. The species of timber which are used in open air can be classified as follows:

- durable – cactus, chestnut, nut, elm, robinia,
- moderately durable – spruce, pine, ash, fir,
- susceptible – maple, birch, lime, willow, poplar, hazel, beech, great maple, aspen.



For timber immersed in water, the classification is connected with time period of immersion:

- durable (over 500 years) – larch, pine, oak, hornbeam, robinia, chestnut, elm,
- moderately durable (50-100 years) – spruce, fir, beech, alder,
- susceptible (under 20 years) – birch, great maple, ash, lime, poplar, willow.

In the sea water the durability of timber is smaller than in fresh water. The durability of timber in soil varies depending on soil permeability – weakly permeable peat soil is much more preserving than highly permeable sand soils. It has also to do with the possibility of its exposure to temperature and moisture variations.

The durability of timber is in range between a few years (e.g. aspen on free air) up to few thousands years (e.g. oak, larch – 2500 years, ebony found in pharaoh's tombs – 4500 years). Timber stored under cover (roofed), and in conditions of stable temperatures during the course of time, can keep its properties over 1000-2000 years. Because of the effects of natural aging, timber loses its properties (e.g. weight) and after approx. 3000 years it disintegrates [1].

The great variety of durability of timber species is connected with a few conditions of chemical nature. One of them is the presence of lignin, whose content varies between 20-30%. This complicated 3-dimensional polymer of phenol compounds covering cellulose chains makes difficult the action of fungi hyphae and can inhibit the growth of many fungi species. The higher durability of coniferous timber, comparing to many deciduous timber species is, among other things, the result of a higher content of lignum.

Other substances, such as tannins, rubbers, resin compounds, proteins, sugars, vitamins and sterols, have a great influence on the durability of timber. The presence of resins, rubbers and tannins may inhibit the access of destructive agents even after its mechanical or chemical processing. The general rule is that sapwood has less content of the aforementioned substances than heartwood – that is why sapwood has lower resistance to destructive agents. It is a well-known fact that woods preserve themselves against fungi and insects by releasing resins.

3 Deterioration mechanisms

The main deterioration mechanisms are: fungi, insects, bacterial attacks, chemical attacks and weathering.

3.1 Fungi decay

Decay fungi have four basic requirements for growth that must be fulfilled simultaneously [3]: wood as a food source, oxygen (because fungi are aerobic organisms), water and appropriate temperatures. These basic requirements are all satisfied within forests, except for the winter period. Fortunately, these conditions are not usually met in building constructions. Sometimes removing that part of the wood that is most vulnerable to decay, i.e., the sapwood (French: aubier, German: Splintholz, Dutch: spinthout, Polish: biel), see Fig. 16.1, is conducive to controlling the basic requirements for the durable performance of wood. In general, fungi do not affect wooden structures if the water content is lower than

22% m^3/m^3 . Wood standards contain strict requirements for the water content of construction wood. The most favourable temperature range for wood decay is between 19 and 31°C; a temperature of 25°C is often optimal. Fungi survive freezing temperatures but die at temperatures exceeding 60°C. Three types of rots are shown in Fig. 16.2.

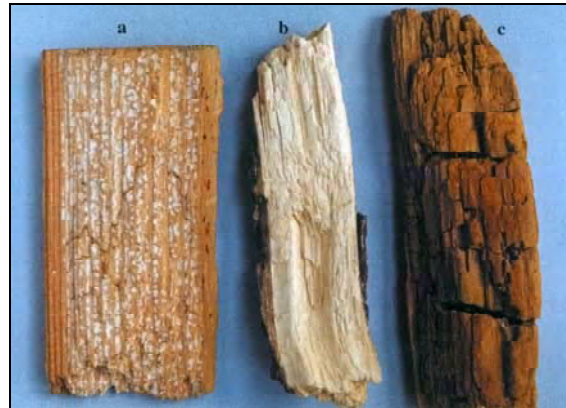

Fig. 16.2 Fungi rot: white partial (a), white full (b), brown (c) [2].

3.2 Beetle attack

The wood-affecting beetles are insects capable of flying, that lay their eggs in wood pores or cracks and have larvae that attack the wood. They are present throughout Europe. Only those beetles that affect seasoned (dried) wood will be discussed. The most important ones are: the Death Watch Beetle (*Xestobium rufovillosum*), (French: grosse vrillette, German: Bunter/Gescheckter Nagekäfer, Dutch: bonte knaagkever or grote houtworm, Polish: tykotek pstry) and the Common Furniture Beetle (*Anobium punctatum*), (French: petite vrillette, German: Gewöhnlicher oder Gemeiner Nagekäfer, Dutch: meubelkever, Polish: kołatek domowy), Fig. 16.3.



Fig. 16.3 Common Furniture Beetle (a, b: adult beetle, c: the larvae)[2]

3.3 Bacterial attack

Bacteria degrade all wood in almost all environments. However, their enzyme production is slow and therefore, they cause relatively little damage in comparison to other „degraders“. Bacteria are able to degrade preserved wood of highly durable species in conditions of low oxygen concentrations [1].



3.4 Natural aging

A natural aging of timber is the process of irreversible changes in its appearance and properties under the influence of long-term operation under the influence of exterior factors like: UV radiation, air, temperature and moisture changes, together with stress conditions. Unfortunately, current knowledge concerning natural aging of timber is very limited (see section 2).

4 Hazard and durability classes

4.1 Hazard classes

The European standard EN 335 “Durability of Wood and Wood-Based Products – Definition of Hazard Classes of Biological Attack” identifies the hazard class (French: classe de risque, German: Gefährdungsklasse, Dutch: risicoklasse, Polish: klasa zagrożenia) of a given service environment and geographical location. It has also localized versions (e.g. PN-EN 335-1:1996 in Poland). According to EN 335 standard the definition of the hazard classes is given in Tab. 16.1.

Hazard class	Exposure	Biological attack	Examples
1	Above ground, covered (dry)	beetles, termites	indoor applications, such a wooden frames of houses covered by roofs and cladding
2	Above ground, covered	beetles, termites	carports, window frames, roofed bridges
3	Above ground, not covered (risk of frequent wetting)	fungi, beetles, termites	bridge beams and decks, sheds, cladding of buildings without protection
4	In contact with soil or fresh water (permanently)	fungi, beetles, termites, bacteria	fences, piers, sheet pile walls, sluice doors
5	In salt water (permanently)	fungi, beetles, termites, marine borers	mooring posts, piers, breakwaters, sea-defence walls

Tab. 16.1 Hazard classes and occurrence of biological agencies according to EN 335-1



4.2 Durability classes

The European standard EN 350 “Durability of Wood and Wood-based Products – Natural Durability of Solid Wood” classifies natural durability in relation to the various agencies of biological attack. There is a five-grade scale for resistance to fungal attack (Tab. 16.2), a two-grade scale (susceptible and durable) for resistance to dry wood-destroying beetles and a three-grade scale (susceptible, moderately durable and durable) for resistance to termites and marine borers. Determination of the classification of a wood species requires the performance of the wood in standardized tests. The examples of wood given in Tab. 16.2 are all for heartwood.

Durability class	Description	Examples
1	Highly durable	teak, azobe, iroko, jarrah, bilinga
2	Durable	Balau/bangkirai, karri, merbau, western red cedar, European oak (French: chêne rouvre, German: Eiche, Dutch eik), robinia (French: robinet faux acacia, German: Robinie, Dutch: robinia)
3	Moderately durable	red merati, Douglas fir
4	Slightly durable	Norway spruce (French: epicea, German: Fichte, Dutch: spar)
5	Not durable	beech (French: hêtre, German: Buche, Dutch: beuk), ash (French: frêne, German: Esche, Dutch: es), poplar (French: peuplier, German: Pappel, Dutch: populier)

Tab. 16.2 Classes of natural durability of wood exposed to fungal attack



4.3 Matching hazard class and durability class

For each application in a specific service environment and geographical location, wood of a specific minimum durability class must be chosen (Tab. 16.3).

Hazard class	Durability class				
	1	2	3	4	5
1	S	S	S	S	S
2	S	S	S	(S)	(S)
3	S	S	(P)		(S) – (P)
4	S		(P)	P	P
5	S	P	(P)	P	P

Tab. 16.3 Hazard classes due to EN-350

In the above Table the meaning of notation is as follows: S: Natural durability sufficient, (S): Natural durability in principle sufficient, but under special service conditions, the wood must be preserved (S)–(P): Natural durability can be sufficient, but the choice of wood, the treatability of the wood by preservatives and the application determine whether or not the wood should be preserved, (P): Treatment is applied, but under some service conditions, the natural durability can be sufficient, P: Treatment is required.

5 References

- [1] Bijen J.;
"Durability of engineering structures",
Woodhead Publishing Ltd, Cambridge, 2003
- [2] Krajewski A., Witomski P.;
"Timber protection",
Wydawnictwo SGGW, Warszawa, 2003 (in Polish)
- [3] Neuhaus H.;
"Timber building engineering"
Polskie Wydawnictwo Techniczne, Rzeszów, 2006 (in Polish)

Chapter No. 18 has been prepared by Andrzej. MARYNOWICZ, Faculty of Civil Engineering, Technical University of Opole / Poland.



FIRE RESISTANCE OF TIMBER STRUCTURES

1 Introduction

There is no simple way of expressing the behaviour of a material with respect to fire. There are two distinct phases to a fire, the developing phase and the fully developed phase and material performance has to be categorised in respect of those two conditions. The developing phase incorporates a number of separate phenomena, the combustibility of the material, the ease of ignition, the speed of the spread of fire/flame across its surface and the rate at which heat is released.

The fully developed phase represents the post flash over conditions where all combustible materials become involved in the fire. The desirable properties are the ability to continue to carry load to contain the fire within the zone of origin without the escape of flames or hot gases and without conducting excessive heat to the unexposed face that may lead indirectly to fire being transmitted to adjacent areas. The ability to resist the fully developed fire is known universally as the fire resistance, but in general terms this can only relate to an element of construction rather than to a material. The performance of even a simple element such as a column or a beam is dependent upon such factors as the end conditions and the magnitude and distribution of any loading.

2 Behaviour of timber and wood-based materials in fire

Considering the behaviour of wood-based materials and solid timber when subjected to the developing fire, wood-based materials will burn and are therefore rated as combustible. Whilst the combustible nature may be modified by the use of coatings or impregnation with flame/fire retarding salts, none of these can render timber, or its related products, non-combustible, even though higher levels of energy may be needed to cause it to burn. Solid timber is not readily ignited and there are very few recorded cases where timber will have been the first material to be ignited. Solid timber will require surface temperatures well in excess of 400 °C if the material is to ignite in the medium to a short term without the pressure of a pilot flame. Even when a pilot flame is present, the surface temperature will have to be in excess of 300 °C for a significant time before ignition occurs. Timber tends to be used as the basis against which other materials are adjudged as timber is not considered to represent an unacceptable ignition risk in most environments. The actual values are related to the density, species, moisture content and shape/section factor.

Timber, being combustible will spread fire across its surface, the phenomena being a number of ignitions each triggering an adjacent ignition. As timber is not readily ignitable, the speed at which flame will spread across its surface is also reasonable for a combustible material. Nearly all countries will permit the use of untreated timber for low risk applications. The rate

at which timber releases heat is obviously highly dependent upon the nature of the initial heating regime, the availability of oxygen and the density, shape and size of the timber member being located. As with all of the above properties, European countries all developed their own bench scale tests for establishing the fundamental performance of materials against these categories and as such there is no pan-European way of expressing the performance of timber against these developing fire conditions. All countries allow the use of timber in many applications, indicating that its behaviour is not considered to be particularly hazardous.

When timber or wood-based materials are exposed to a fully developed fire they exhibit many desirable characteristics. Whilst the exposed surfaces will ignite when the heat flux becomes great enough, and initially burn fairly vigorously it soon builds up a layer of insulating charcoal, see Fig. 17.1. As wood is a poor conductor of heat there is a very low transmission of heat into remaining unburned material. This has many benefits.

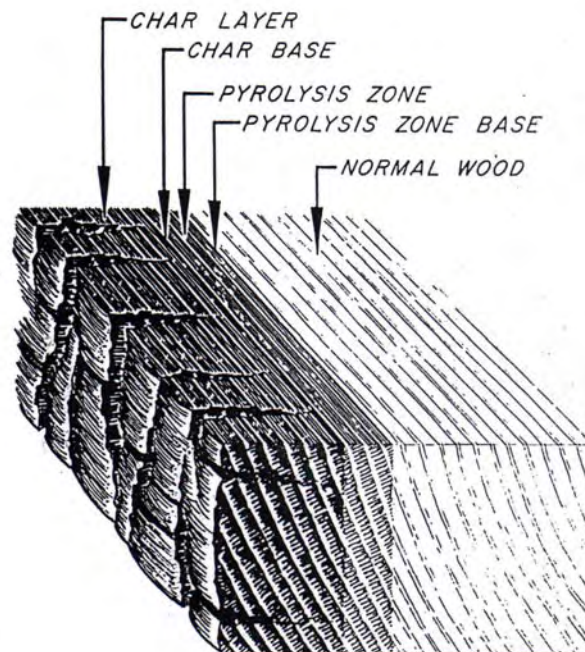

Fig. 17.1 The changes in timber under the influence of fire

In case of solid timber, the core section remains cool only a short distance behind the burning zone. As a consequence, the temperature of the residual section is cool and the construction does not have to accommodate damaging thermal expansions. Also, because the core remains cool, all of the cold state physical properties of the timber are retained and any loss of load bearing capacity is as a result of the reduced cross-section, rather than a change in the physical properties. When wood-based sheet materials are used in the construction of separating elements, both structural members and linings, the low thermal conductivity prevents the heat from being easily transmitted from the hot to the cold face of the construction.

The fully developed fire is characterised in tests by the standard temperature-time curve given in ISO 834 (see Fig. 17.2) or the equivalent national standard. The relevant criteria are given as:

- loadbearing capacity (separating and non-separating elements)
- integrity (separating elements)
- insulation (separating elements)

Critical deflection and rates of deflection are normally given as criteria for loadbearing capacity. The integrity is generally evaluated by means of the development of gaps of excessive size (set nationally) or the ignition of a cotton fibre pad. Insulation is deemed to be compromised if a mean temperature rise of 140 °C is experienced or a maximum rise of 180 °C is exceeded.

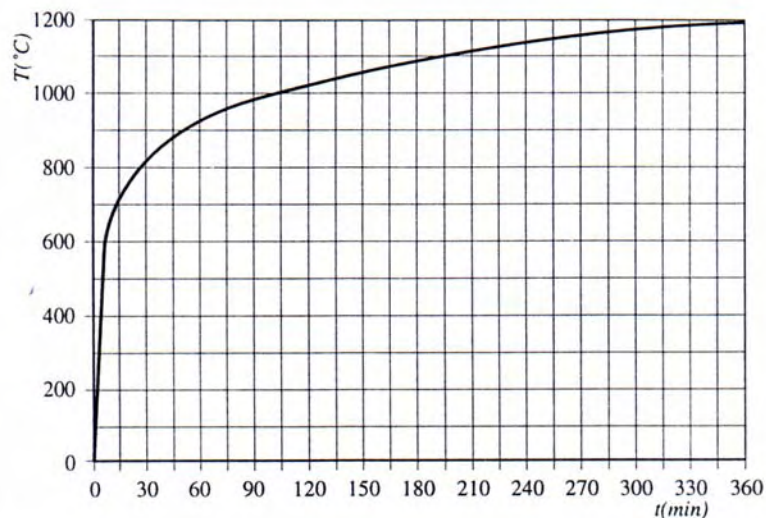

Fig. 17.2 Standard temperature-time curve according to ISO

Timber will only lose loadbearing capacity when the cross-section of the non-fire damaged/residual section is reduced to the size where the stress in the section as a result of the applied load is in excess of the strength of the timber.

Timber-based materials will not fissure or shrink and gaps may develop until the timber is so thin that burn-through is close and the rise in temperature will only exceed the criteria when the thin, heat affected zone reaches the outer face and again burn-through will soon follow. Timber is highly predictable when exposed to the fully developed fire conditions.

Many test results for wood and wood-based materials have shown a linear relationship between charring depth and time. A constant charring rate can therefore be assumed for calculation of the fire resistance of a section. The following charring rates β_0 , in Tab. 17.1, can be used for simple methods of structural fire design without the need to take a special consideration of the rounding of edges. Thus the residual cross-section is considered to be

rectangular in fire design calculations. The more accurate assessment of the residual cross-section covering rounding of arises allows a slower charring rate.

Material		β_0 in mm/min
Solid softwood	with $\rho_k \geq 290 \text{ kg/m}^3$ and min $a \geq 35 \text{ mm}$	0.8
Glued laminated softwood	with $\rho_k \geq 290 \text{ kg/m}^3$	0.7
Wood panels	with $\rho_k = 450 \text{ kg/m}^3$ and $t_p = 20 \text{ mm}$	0.9
Solid hardwood	with $\rho_k \geq 450 \text{ kg/m}^3$	0.5
Glued laminated hardwood	with $\rho_k \geq 450 \text{ kg/m}^3$	0.5
Oak		0.5
Solid hardwood	with $\rho_k \geq 290 \text{ kg/m}^3$	0.7
Glued laminated hardwood	with $\rho_k \geq 290 \text{ kg/m}^3$	0.7
Plywood	with $\rho_k = 450 \text{ kg/m}^3$ and $t_p = 20 \text{ mm}$	1.0
Wood-based panels	with $\rho_k = 450 \text{ kg/m}^3$ and $t_p = 20 \text{ mm}$	0.9

Tab. 17.1 Design charring rates β_0
(with t_p : thickness of wood and wood-based panels, a : width or depth of cross-section)

For closely packed multiple layers the charring rate may be calculated based on the total thickness.

3 Fire resistance of timber members

Generally, the same principles are followed to calculate fire resistance as in standard design. Thus for actions and for material properties characteristic-values are applied.

3.1 Verification

The effect of actions $E(t)$ and the resistance of timber members $R(t)$ during fire exposure is in principle shown in Fig. 17.3. The fire resistance is reached at the time t_f when $R(t)$ becomes less than $E(t)$. Thus the verification on the design level is $E_{f,d} < R_{f,d}$.

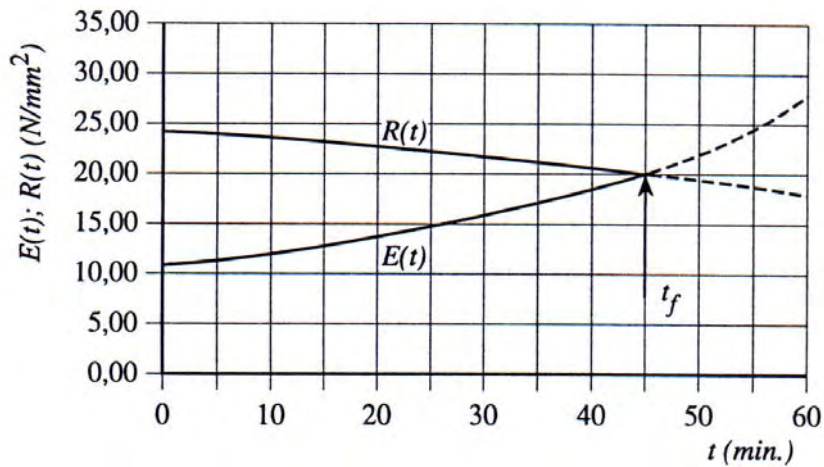

Fig. 17.3 Effect of actions $E(t)$ and resistance of timber members $R(t)$ during fire exposure (with: $E_{f,d}$ is the design effect of actions in the event of fire, $R_{f,d}$ is the design resistance in the event of fire)

3.2 Temperature profiles

The temperature for the actual charline is of a magnitude of about 300 °C. The charline derived from β_0 can be put at 200 °C. For a fire exposure more than 20 minutes, ambient temperatures are reached at a distance below the charline which remains constant for the remaining exposure time. This distance is about 30 mm from the charline and for the charline related to β_0 about 25 mm. The shape of the temperature profile is given in Fig. 17.4.

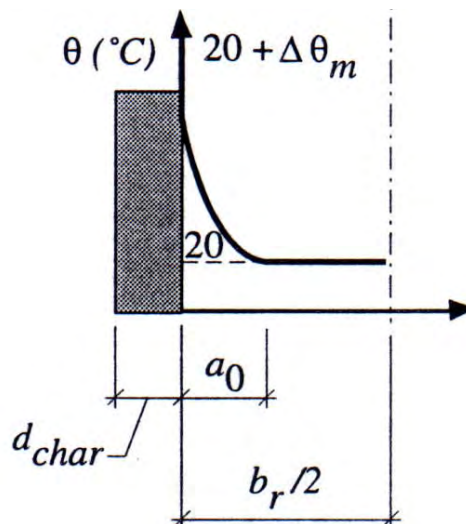

Fig. 17.4 Temperature profile for $b_r > 2 a_0$

3.3 Fire resistance of joints

The load-bearing capacity of fasteners made of fire-unprotected steel is considerably weakened by heat. All-round protection with wood or wood based materials offers resistance to heat, thereby protecting the steel members. The area of the non-protected surfaces of the steel members is therefore relevant to the fire-behaviour of fasteners made of steel.

For unprotected wood-to-wood joints with spacings, distances and side member dimensions complying with minimum requirements given in EC5: Part 1-1, times of fire resistance may be taken from Tab. 17.2.

	Time of fire resistance $t_{fi,d}$ [min]	Provisions*
Nails	15	$d \geq 2.8$ mm
Screws	15	$d \geq 3.5$ mm
Bolts	15	$t_1 \geq 45$ mm
Dowels	20	$t_1 \geq 45$ mm
Connectors according to EN 912	15	$t_1 \geq 45$ mm
* t_1 is the thickness of the side member		

Tab. 17.2 Time of fire resistance of unprotected joints with side members of wood

For a fire resistance periods greater than those given in Tab. 17.2, but not more than 30 minutes, and using joints with dowels, nails or screws with non-projecting heads, then

- the thickness of side members
 - the end and edge distance to fasteners
- should be increased by a_{fi} (see Fig. 17.5) given as:

$$a_{fi} = \beta_0 \cdot k_{flux} \cdot (t_{f,req} - t_{fi,d}) \quad (17.1)$$

where

β_0 is the charring rate according to Tab. 17.1,

k_{flux} a coefficient taking into account increased heat flux through the fastener,

k_{flux} should be taken as $k_{flux} = 1.5$,

$t_{f,req}$ the required time of the fire resistance,

$t_{fi,d}$ the time of the fire resistance of the unprotected joint according to Tab. 17.2

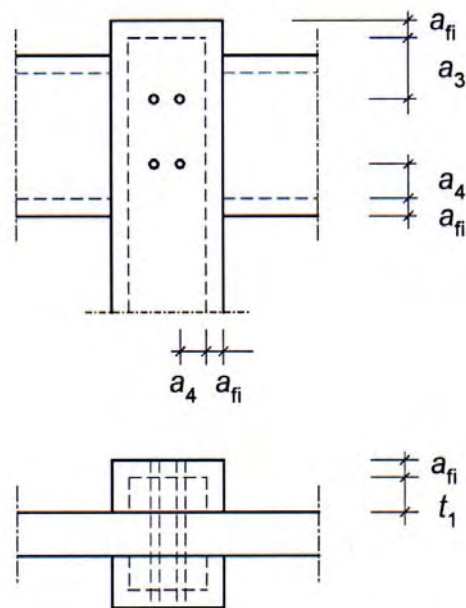

Fig. 17.5 Extra thickness and extra end and edge distances of joints

4 References

- [1] EN 1995-1-2:2004, Design of Timber Structures – Part 1-2: General – Structural fire design
- [2] Hartl, H.;
“Fire resistance of timber members “,
Chapter B17 from “STEP 1 – Timber Engineering“; First Edition, Centrum Hout,
The Netherlands, 1995

Chapter No. 17 has been prepared by Petr KUKLÍK, Department of Steel and Timber Structures, Czech Technical University in Prague / Czech Republik.



TIMBER STRUCTURES IN AGGRESSIVE ENVIRONMENTS

1 Introduction

The surfaces of timber elements, especially for those of roof constructions, are susceptible to chemical corrosion leading them to a maceration process (*lat.*: maceratio – soften, steep). This process has a very complex nature and has strong dependence on the moisture content changes in the surrounding air. The depth of maceration reaches even 50 mm in some cases. But in many cases, concerned especially with industrial applications, we can see influences of many chemical substances in the fluid and (mostly) gaseous state.

2 Resistance of timber to acids and bases

2.1 Acidic environments

Timber elements that are exposed to the influences of acids reveal high resistance to these environments. In the range of 2 up to 7 pH, the influence of acids and sulphates is negligible. Only in environments with pH lower than or equal to 2 will timber elements start to corrode rapidly. For example, larch elements work very efficiently in spinning mills chimneys [1].

2.2 Base environments

The bases with 8 to 10 pH generate an intense timber expansion, after which carbohydrates dissolution follows together with saponification of resins. Under higher base concentrations, the dissolution of lignin occurs.

2.3 Gaseous media

Experimental research into the influences of some gases [1], i.e. sulphur dioxide SO_2 , hydrogen sulfide H_2S , ammonia NH_3 and chlorine Cl_2 reveals, in most cases, the negative impact on their physical properties (Tab. 18.1). Investigated pine samples were conditioned for 90 days in a closed chamber, after that their strength properties were measured. The result was that higher negative influences were generated by Cl_2 .

Similar investigations were made on samples taken from a wooden roof of a phosphorous products factory in Szczecin (Poland). The samples were tested for compression and tension resistance (Tab. 18.2). An interesting fact is that approx. 50% of the samples had compression strength higher than reference samples (in accordance with polish standards), while their tensile strength was much lower than the reference sample. That effect was caused mainly by the high concentration of H_2F_2 , together with a strong influence of moisture from the surrounding air.



An additional factor was the presence of an 8 cm hardened ash layer at the bottom flange of the truss, which had strong sorption properties. This was the reason for the high water accumulation and additional water-gas reactions.

Type of strength	Reference samples strength [kPa]	SO ₂	H ₂ S	NH ₃	Cl ₂
Bending	1069	610	936	761	515
Compression	560	509	637	554	270
Tension	1002	730	1095	938	343

Tab. 18.1 Influence of some gases on timber strength [1]

Type of strength	Tension		Compression	
	Investigated [kPa]	Reference [kPa]	Investigated [kPa]	Reference [kPa]
R_{max}	940	-	690	-
R_{min}	149	550	487	300
R_{mean}	440	1000	606	400

Tab. 18.2 Results of timber sample investigation [1]

Substance	Concentration [%]	Coniferous species				Deciduous species	
		Spruce	Fir	Pine	Larch	Oak	Beech
Acetic acid	2	I	I	I	I	I	I
	5	I	I	I	I	I	I
	10	I	I	I	I	II	I
Milk acid	2	I	I	I	I	I	I
	5	I	I	I	I	I	I
	10	I	I	I	I	I	I
Nitric acid	2	I	I	I	I	II	II
	5	I	II	II	I	II	II
	10	I	II	I	I	III	II
Hydrochloric acid	2	I	I	I	I	I	I
	5	II	II	II	II	II	II
	10	II	II	II	II	III	IV
Sulphuric acid	2	I	I	I	I	I	I
	5	I	I	I	I	I	I
	10	II	II	II	II	III	III
Ammonia	2	I	I	I	I	II	II
	5	I	I	I	I	IV	III
	10	II	II	II	II	IV	IV
Sodium hydroxide	2	I	I	I	I	II	II
	5	II	II	II	II	IV	III
	10	III	II	III	III	IV	IV

Tab. 18.3 Resistance on chemical substances in T=20°C acc. to [2]

As can be seen in Tab. 18.3, coniferous species have generally greater resistance to chemical affects. That is why coniferous species (in solid and glued constructions) are commonly used in storage and production buildings, especially those for storage of salt, fertilizers, coal and tannery warehouses. Also roof constructions in rubbish depots, sewage-treatment plants, brine baths and agricultural buildings, are often made of timber.



3 References

- [1] Mileczarek Z.;
“Timber in building constructions”,
6th International conference on timber structures, Szczecin-Międzyzdroje 2004,
Szczecin 2004, (in Polish),
- [2] Neuhaus H.;
“Timber building engineering”,
Polskie Wydawnictwo Techniczne, Rzeszów, 2006, (in Polish)

Chapter No. 18 has been prepared by Andrzej MARYNOWICZ, Faculty of Civil Engineering,
Technical University of Opole / Poland.

